

Pulegge a gole trapezoidali di serie

Standard V-pulleys

Poulies à gorges trapézoïdales standard

Standard Keilriemenscheiben

Premessa

Sul mercato esistono varie tipologie di **cinghie trapezoidali**, fra di esse, quelle piu' diffuse sono: le "strette" SPZ - SPA - SPB - SPC (DIN 7753/1), le "classiche" Z - A - B - C (DIN 2215 - ISO e UNI 5265) e le "strette americane" 3V - 5V (RMA - MPTA). Con le **pulegge trapezoidali "strette"** (DIN 2211 - ISO 4183) **prodotta dalla SIT** e illustrate in questo catalogo, e' possibile utilizzare, correttamente, tutte le tipologie di cinghie sopra elencate (salvo la C).

Introduction

On the market you find many **V-belts**, among which the most used are the "narrow" SPZ - SPA - SPB - SPC (DIN 7753/1), the "classical" Z - A - B - C (DIN 2215 - ISO and UNI 5265) and the american narrow 3V - 5V (RMA-MPTA). On the "**narrow V-belt pulleys**" (DIN 2211 - ISO 4183) it is possible to use correctly all these V-belts. SIT presents in this catalogue its own range of standard pulleys, which are, in regard to the grooves, all produced according to DIN 2211 (ISO 4183) except for C-section.

Introduction

Sur le marché différentes courroies trapézoïdales sont distribuées: les courroies les plus utilisées sont les courroies "étroites" SPZ - SPA - SPB - SPC (DIN 7753/1) et les "classiques" Z - A - B - C (DIN 2215 - ISO et UNI 5265) ainsi que les courroies normes américaines 3V - 5V (RMA - MPTA) et compte tenu de la norme sur les poulies à gorge série étroite (DIN 2211 - ISO 4183), il est possible d'utiliser l'ensemble de la gamme avec les poulies fabriquées par SIT. SIT présente dans ce catalogue sa propre gamme de poulies, fabriquées au niveau des gorges suivant la norme DIN 2211 (ISO 4183) sauf pour la section C.

Einleitung

Da sich auf dem Markt verschiedene **Keilriemen-Normungen** befinden, unter denen die verwendetesten von den "Schmalkeilriemen" SPZ - SPA - SPB - SPC (DIN 7753/1), den "Klassischen Keilriemen" Z - A - B - C (DIN 2215 - ISO und UNI 5265) dargestellt sind und den "**Schmalkeilriemenscheiben**" (DIN 2211 - ISO 4183) eine eiwandfreie Verwendung aller dieser Riemen möglich ist, führt SIT in diesem Katalog die eigene Standardscheibenreihe vor. Alle diese Scheiben werden - mit Rücksicht auf die Rillen - nach DIN 2211 (ISO 4183) mit Ausnahme des C-Schnittes hergestellt.

Tabella delle compatibilità tra i principali tipi di cinghie trapezoidali e le pulegge SIT

Matching table between the main V-belts and SIT-pulleys

Tableau de correspondance entre les principales courroies et les poulies SIT

Paarungstabelle zwischen den Hauptkeilriemen und den SIT-Scheiben

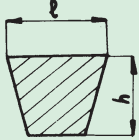
CINGHIE - BELTS - COURROIES - RIEMEN -												
		DIN 7753/1 - ISO-R459-460				RMA - MPTA			UNI 5265 - ISO R52-253 - DIN 2215			
		SPZ	SPA	SPB	SPC	3V	5V	8V	Z	A	B	C
l x h		9,7 x 8	12,7 x 10	17 x 13	22 x 18	9,5 x 8	16 x 13,5	25,5 x 23	10 x 6	13 x 8	17 x 11	22 x 14
PULEGGE SIT - SIT PULLEYS - POULIES SIT - SIT-SCHEIBEN (DIN 2211)												
PT	SPZ	○	-	-	-	○*	-	-	○	-	-	-
	SPA	-	○	-	-	-	-	-	-	○	-	-
	SPB	-	-	○	-	-	○*	-	-	-	○	-
	C	-	-	-	X	-	-	-	-	-	-	○
PBT	SPZ	○	-	-	-	○*	-	-	○	-	-	-
	SPA	-	○	-	-	-	-	-	-	○	-	-
	SPB	-	-	○	-	-	○*	-	-	-	○	-
	SPC	-	-	-	○	-	-	-	-	-	-	○
PCT	SPZ	○	-	-	-	○*	-	-	○	-	-	-
	SPA	-	○	-	-	-	-	-	-	○	-	-
	SPB	-	-	○	-	-	○*	-	-	-	○	-
	SPC	-	-	-	○	-	-	-	-	-	-	○

○ = SI X = NO

○ = YES X = NO

○ = OUI X = NON

○ = JA X = NEIN

* Il passo fra le gole delle pulegge SPZ è differente da quello delle 3V, così il passo delle SPB è differente da quello delle 5V.

* Pitch among the grooves of SPZ pulleys is different from 3V. The pitch is also different between SPB and 5V.

* Le pas entre 2 gorges de poulies SPZ et 3V est différent, de même pour les poulies SPB et 5V.

* Der Abstand unter den Rillen der SPZ-Scheiben unterscheidet sich von 3V. Der entsprechende Abstand zwischen SPB und 5V ist ebenfalls unterschiedlich.



Tipi costruiti

Manufactured types

Types de poulies fabriquées

Ausführungen

PULEGGE PT

Pulegge a gole trapezoidale adatte per le normali applicazioni. Queste pulegge sono adatte a ricevere i seguenti tipi di cinghie:

- SPZ-Z-3V
- SPB-B-5V
- SPA-A
- C

PT - PULLEYS

Traditional V groove pulleys suitable for normal applications for use with the following belt types:

- SPZ-Z-3V
- SPB-B-5V
- SPA-A
- C

POULIES - PT

Poulies à gorges trapézoïdales prévues pour des applications standard, permettent le montage des courroies suivantes:

- SPZ-Z-3V
- SPB-B-5V
- SPA-A
- C

PT - KEILRIEMENSCHLEIBEN

Keilriemenscheiben für normale und weniger belastete Antriebe. Diese Scheiben sind in folgenden Ausführungen lieferbar:

- SPZ-Z-3V
- SPB-B-5V
- SPA-A
- C

PULEGGE PBT PER BUSSOLA CONICA SER-SIT®

Pulegge a gole trapezoidali per il montaggio con bussola conica SER-SIT®. Queste pulegge sono atte a ricevere indifferentemente tutti i tipi di cinghie trapezoidali e cioè:

- SPZ-Z-3V
- SPB-B-5V
- SPA-A
- SPC-C

PBT - PULLEYS FOR SER-SIT® TAPER BUSH

Pulleys with V Section grooves pre-machined for SER-SIT® bushing. The following V Belts are suitable for use with these pulleys:

- SPZ-Z-3V
- SPB-B-5V
- SPA-A
- SPC-C

POULIES PBT POUR MOYEURS AMOVIBLES SER-SIT®

Poulies à gorges trapézoïdales prévues pour le montage des moyeux SER-SIT®, permettent le montage des courroies suivantes:

- SPZ-Z-3V
- SPB-B-5V
- SPA-A
- SPC-C

PBT - SCHEIBEN ZUR MONTAGE MIT SER-SIT® SPANNBUCHSE

Spannbuchenscheiben geeignet zur Montage mit konischen SER-SIT® Spannbuchsen. Diese Keilriemenscheiben können für folgende Keilriementypen verwendet werden:

- SPZ-Z-3V
- SPB-B-5V
- SPA-A
- SPC-C

PULEGGE PCT CON MOZZO SOVRADIMENSIONATO PER CALETTATORI

Pulegge a gole trapezoidali con mozzo sovradimensionato adatte per calettatori. Queste pulegge sono atte a ricevere indifferentemente tutti i tipi di cinghia trapezoidali e cioè:

- SPZ-Z-3V
- SPB-B-5V
- SPA-A
- SPC-C

PCT - PULLEYS WITH OVER-SIZED HUB FOR SELF-LOCKING UNITS

Pulleys with oversized hub for self-locking units. The following V Belts are suitable for use with these pulleys:

- SPZ-Z-3V
- SPB-B-5V
- SPA-A
- SPC-C

POULIES PCT AVEC MOYEURX SURDIMENSIONNÉS POUR MOYEURS DE SERRAGE

Poulies à gorges trapézoïdales avec moyeux prévus pour le montage des moyeux de serrage, permettent le montage des courroies suivantes:

- SPZ-Z-3V
- SPB-B-5V
- SPA-A
- SPC-C

PCT - SCHEIBEN MIT ÜBERDIMENSIONIERTER NABE ZÜR MONTAGE MIT SPANNSATZE

Scheiben mit überdimensionierter Nabe geeignet zur Montage mit Spannsätzen. Diese Keilriemenscheiben können für folgende Keilriementypen verwendet werden:

- SPZ-Z-3V
- SPB-B-5V
- SPA-A
- SPC-C

PT



PBT

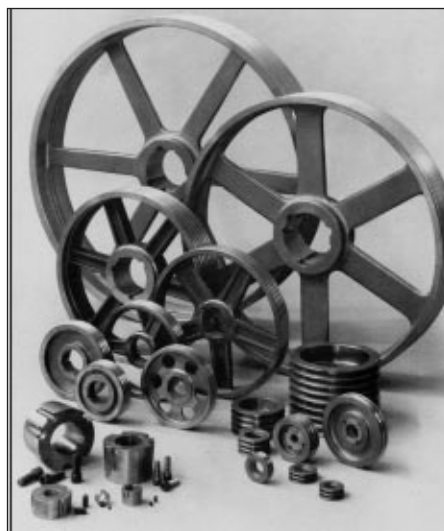

PCT



Materiali e caratteristiche

Materiali

Le pulegge PT - PBT e PCT sono costruite in ghisa DIN 1691 GG20 - GG25

Caratteristiche

Le nostre pulegge sono adatte per funzionare sino ad una velocità periferica di 35 m/s. Le caratteristiche dimensionali rispondono ad un elevato standard, essendo tornite esclusivamente con macchine a controllo numerico oppure con tornitrici automatiche

Tattamento protettivo

Le pulegge PT-PBT e PCT sono protette mediante fosfatazione al manganese nera.

Equilibratura

Le pulegge PBT sono equilibrate staticamente UNI 4218 - VDI 2060 entro il grado G. 6.3 (a 1.500 rpm fino a PD ≤ 400 mm, a 35 m/s per PD > 400 mm). Le PT e PCT non sono equilibrate non avendo i fori finiti.

Tolleranze

(Vedi tabella in basso)

- ☆ Tolleranza del diametro primitivo dw
- ◇ Tolleranza di eccentricità riferita al diametro esterno
- ◇ Tolleranza di oscillazione laterale riferita al diametro primitivo
- Massima differenza tra i diametri primitivi delle gole di una stessa puleggia:
 - 0,4 mm para SPZ-SPA-SPB
 - 0,6 mm para SPC

Materials and features

Materials

Our PT-PBT and PCT pulleys are made of cast iron, quality DIN 1691 GG20 - GG25.

Features

The dimensions are very precise as the pulleys are turned exclusively by means of CNC or automatic lathes. These pulleys can be used for speed up to 35 m/s.

Protective treatment

Our PT-PBT and PCT pulleys are black phosphated.

Balancing

Our PBT pulleys are statically balanced UNI 4218 - VDI 2060, G6,3 degree (at 1.500 rpm up to PD = 400 mm and at 35 m/s over PD = 400 mm). The PT and PCT pulleys are not balanced as they do not have a finished bore.

Tolerances

(See table below)

- ☆ Tolerance of pitch diameter dw
- ◇ Tolerance of eccentricity concerning the outside diameter
- ◇ Tolerance of lateral oscillation concerning the pitch diameter
- Max. difference among the pitch diameters of grooves of the same pulley:
 - 0,4 mm for SPZ - SPA - SPB
 - 0,6 mm for SPC

Matériaux et caractéristiques

Matériaux

Nos poulies PT-PBT et PCT sont en fonte DIN 1691 GG20 - GG25.

Caractéristiques

La fabrication est particulièrement précise, les poulies sont réalisées sur des tours automatiques et à commande numérique. La vitesse maximum de ces poulies en fonte ne doit pas dépasser 35 m/s.

Protection traitement

Les poulies PT-PBT et PCT sont protégées par une phosphatation noir.

Equilibrage

Degré d'équilibrage statique selon UNI 4218 - VDI 2060, G6,3 pour les poulies PBT (à 1.500 tour/min jusqu'à PD = 400 mm et à 35 m/s pour PD > 400 mm). Les poulies PT et PCT ne sont pas équilibrées car leurs moyeux ne sont pas alésés.

Tolérances

(Voir tableau ci-dessous)

- ☆ Tolérance du diamètre primitif dw
- ◇ Tolérance de concentricité au niveau du diamètre extérieur
- ◇ Tolérance d'oscillation au niveau du diamètre extérieur
- Différence maximum entre les diamètres primitifs de chaque gorge d'une même poulie:
 - 0,4 mm pour SPZ-SPA-SPB
 - 0,6 mm pour SPC

Werkstoffe und Eigenschaften

Werkstoffe

Unsere PT-PBT und PCT Keilriemenscheiben werden aus Grauguss hergestellt DIN 1691 GG20 - GG25.

Eigenschaften

Die Abmessungen sind äusserst genau, da die Scheiben ausschliessend durch numerisch gesteuerten Maschinen oder durch automatische Drehmaschinen gedreht werden. Diese Scheiben sind für eine max. Umfangsgeschwindigkeit von 35 m/s ausgelegt.

Schutzbehandlung

Unsere PT-PBT und PCT Scheiben sind schwarz phosphatiert.

Auswuchten

Unsere PBT Scheiben sind innerhalb der UNI 4218 - VDI 2060, G6,3 statisch ausgewuchtet (PD ≤ 400 mm: 1.500 rpm; PD > 400 mm: 35 m/s). Die PT-PCT Scheiben werden nicht ausgewuchtet, da diese keine Fertigbohrung haben.

Toleranzen

(Siehe Tabelle unten)

- ☆ Toleranz des Wirkdurchmessers dw
- ◇ Rundlauf toleranz am Auswendurchmesser
- ◇ Planlauf toleranz an der Flanke in Höhe des Wirkdurchmessers
- Max. Abweichung der Wirkdurchmesser der Rillen derselben Scheibe:
 - 0,4 mm für SPZ - SPA - SPB
 - 0,6 mm für SPC

dw [mm]	50	56	63	71	80	90	100	112	118	125	132	140	150	160	180	190	200	212	
☆ [mm]	+	0,4	0,4	0,5	0,6	0,6	0,7	0,8	0,9	1,0	1,0	1,1	1,2	1,3	1,4	1,5	1,6	1,7	
	-	0,4	0,4	0,5	0,6	0,6	0,7	0,8	0,9	1,0	1,0	1,1	1,2	1,3	1,4	1,5	1,6	1,7	
◇ [mm]	0,2								0,3						0,4				

dw [mm]	224	236	250	280	300	315	355	400	450	500	560	630	710	800	900	1000	1120	1250	
☆ [mm]	+	1,8	1,9	2,0	2,2	2,4	2,5	2,8	3,2	3,6	4,0	4,5	5,0	5,7	6,4	7,2	8,0	9,0	10,0
	-	1,8	1,9	2,0	2,2	2,4	2,5	2,8	3,2	3,6	4,0	4,5	5,0	5,7	6,4	7,2	8,0	9,0	10,0
◇ [mm]	0,4			0,5					0,6				0,8			1			



Dimensioni delle gole

Groove dimensions

Dimensions des gorges

Rillenmassen

Secondo DIN 2211

Complying to DIN 2211

Suivant DIN 2211

Nach DIN 2211

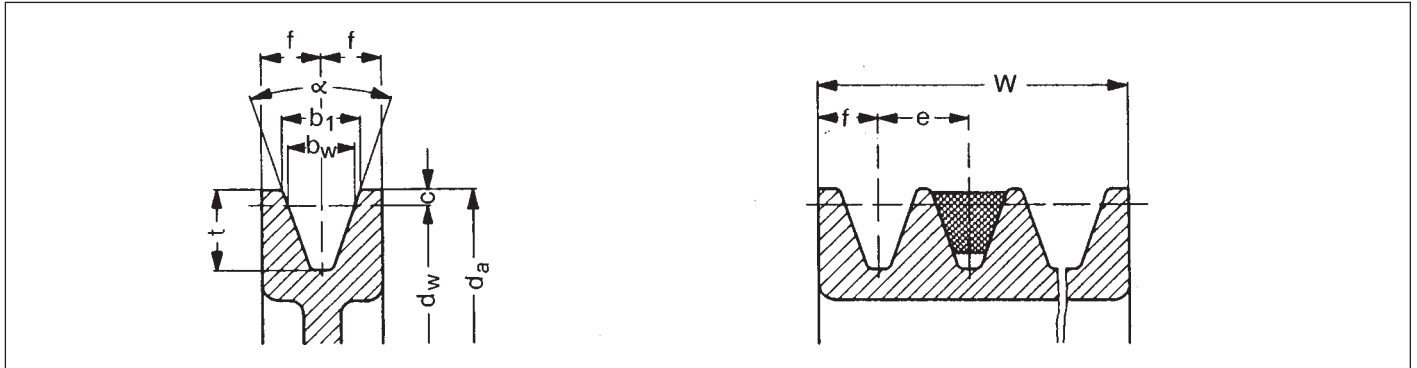

Tab. 1

SEZIONI SECTIONS SECTIONS PROFILE		SPZ [mm]	SPA [mm]	SPB [mm]	C/SPC [mm]
b _w [mm]		8,5	11	14	19
b ₁ [mm]		9,7	12,7	16,3	22
c [mm]		2	2,8	3,5	4,8
e [mm]		12±0,3	15±0,3	19±0,4	25,5±0,5
f [mm]		8±0,6	10±0,6	12,5±0,8	17±1
t [mm]	min.	11 ^{+0,6}	13,8 ^{+0,6}	17,5 ^{+0,6}	C:20 SPC:23,8 ^{+0,6}
α	34° per - for - pour - für - 38° Tolleranza - Tolerance - Tolérance - Toleranz	dw [mm]			
		>80	>118	>190	>315
		±1°	±1°	±1°	±30'
<p>W</p> <p>• Larghezza della fascia W per un numero gole Z</p> <p>• Crown width W for number of grooves Z</p> <p>• Largeur W pour un nombre de dents Z</p> <p>• Kranzbreite W bei Rillenzahl Z</p> <p>[mm]</p>	Z = 1	16	20	25	34
	2	28	35	44	59,5
	3	40	50	63	85
	4	52	65	82	110,5
	5	64	80	101	136
	6	76	95	120	161,5
	7	88	110	139	187
	8	100	125	158	212,5
	9	112	140	177	238
	10	124	155	196	263,5
	11	136	170	215	289
	12	148	185	234	314,5
Tolleranza - Tolerance - Tolérance - Toleranz	di: (Z-1) e [mm]	±0,6	±0,6	±0,8	±1,0

Forme costruttive

Construction shapes

Forme de construction

Bauforme

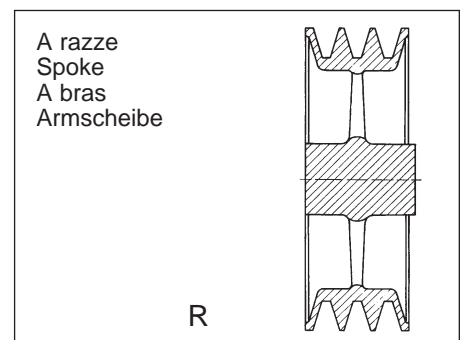
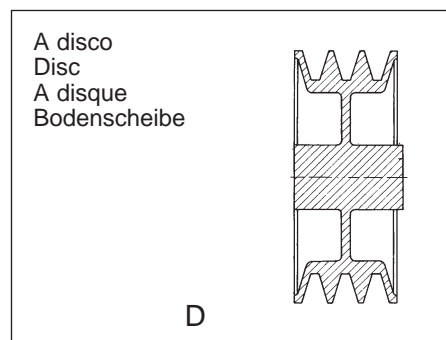
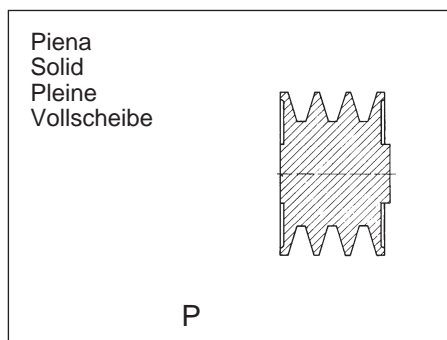

Pulegge PT

PT pulleys

Poulies PT

PT Keilriemenscheiben

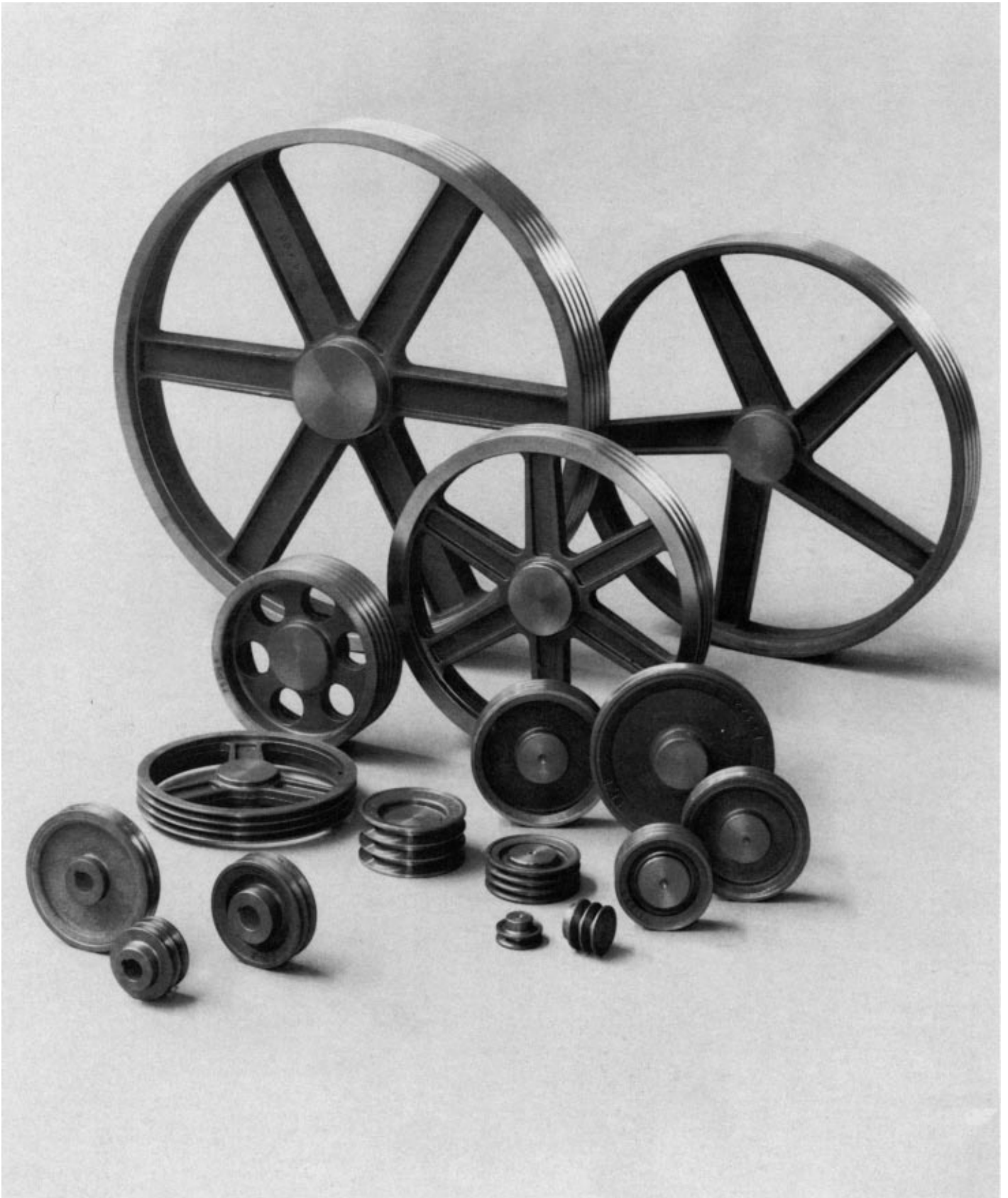

Dimensioni delle pulegge PT

PT pulley dimensions

Dimensions des poulies PT

Abmessungen der PT Keilriemenscheiben

“PT” SPZ-Z-3V

Diametro primitivo pitch diameter diamètre primitif Wirkdurchmesser dw [mm]	gole grooves gorges Rillen N°	forma size forme Ausführung fig.	M [mm]	L [mm]
50	1	P	32*	28
	2	P	35*	35
	3	P	35*	44
	4	P	35*	56
56	1	P	32**	28
	2	P	40**	35
	3	P	42**	44
	4	P	42**	56
63	1	P	40	28
	2	P	40	35
	3	P	42	44
	4	P	42	56
71	1	P	40	28
	2	P	48	35
	3	P	50	44
	4	P	50	56
75	1	P	40	28
	2	P	50	35
	3	P	50	44
	4	P	50	56
80	1	D	40	28
	2	P	50	35
	3	P	50	44
	4	P	65	56
	5	P	65	68
85	1	D	40	28
	2	D	50	35
	3	P	50	44
	4	P	65	56
	5	P	68	68
90	1	D	40	28
	2	D	50	35
	3	D	50	44
	4	P	65	56
	5	P	68	68
95	1	D	45	28
	2	D	50	35
	3	D	50	40
	4	P	65	56
	5	P	68	68
100	1	D	45	28
	2	D	50	35
	3	D	60	40
	4	P	65	56
	5	P	68	68
106	1	D	45	28
	2	D	50	35
	3	D	60	40
	4	D	65	56
	5	D	68	68
112	1	D	45	28
	2	D	50	35
	3	D	60	40
	4	D	68	52
	5	D	68	60
118	1	D	45	28
	2	D	50	35
	3	D	60	40
	4	D	68	52
	5	D	75	60

“PT” SPZ-Z-3V

W: see Tab. 1

Diametro primitivo pitch diameter diamètre primitif Wirkdurchmesser dw [mm]	gole grooves gorges Rillen N°	forma size forme Ausführung fig.	M [mm]	L [mm]
125	1	D	45	28
	2	D	50	35
	3	D	60	40
	4	D	68	52
	5	D	75	60
132	1	D	45	28
	2	D	50	40
	3	D	60	40
	4	D	68	52
	5	D	75	60
140	1	D	45	28
	2	D	60	40
	3	D	60	40
	4	D	68	52
	5	D	75	60
150	1	D	55	32
	2	D	60	40
	3	D	68	45
	4	D	68	52
	5	D	80	60
160	1	D	55	32
	2	D	60	40
	3	D	68	45
	4	D	68	52
	5	D	80	60
180	1	D	55	32
	2	D	60	40
	3	D	68	45
	4	D	80	52
	5	D	80	60
200	1	D-6F	55	32
	2	D-6F	65	40
	3	D-6F	68	45
	4	D-6F	80	52
	5	D-6F	80	60
224	1	3R	55	32
	2	3R	65	40
	3	3R	68	45
	4	3R	80	52
	5	3R	80	60
250	1	3R	55	32
	2	3R	62	40
	3	3R	68	45
	4	3R	80	52
	5	3R	80	60
280	1	3R	68	45
	2	3R	68	45
	3	3R	80	50
	4	3R	80	52
	5	3R	96	60
315	1	3R	68	45
	2	3R	68	45
	3	3R	80	50
	4	3R	96	55
	5	3R	96	60
355	1	3R	68	45
	2	3R	68	45
	3	3R	80	50
	4	3R	96	55
	5	3R	96	60

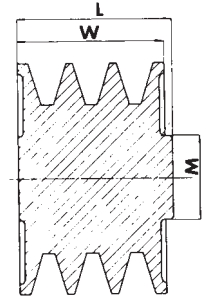

P

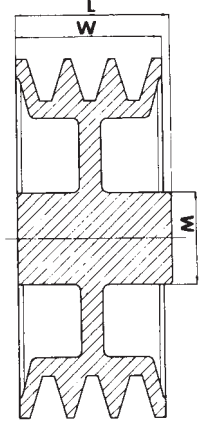

D

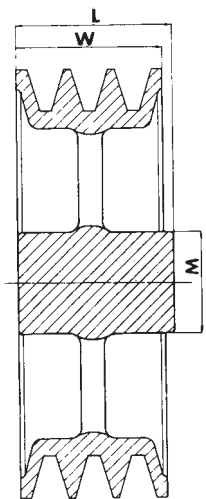

R

* Attenzione: il diametro fondo gola è di 32 mm
Caution: diameter of bottom groove is 32 mm.
Attention: le diamètre de fond de gorge est 32 mm.
Achtung: Rillendurchmesser 32 mm.

** Attenzione: il diametro fondo gola è di 38 mm
Caution: diameter of bottom groove is 38 mm.
Attention: le diamètre de fond de gorge est 38 mm.
Achtung: Rillendurchmesser 38 mm.

“PT” SPA-A

Diametro primitivo pitch diameter diamètre primitif Wirkdurchmesser dw [mm]	gole grooves gorges Rillen N°	forma size forme Ausführung fig.	M [mm]	L [mm]
50	1	P	32*	35
	2	P	40*	45
	3	P	40*	54
56	1	P	35**	35
	2	P	40**	45
	3	P	40**	54
63	1	P	40	35
	2	P	40	45
	3	P	40	54
	4	P	40	68
	5	P	40	84
71	1	P	40	35
	2	P	50	45
	3	P	52	54
	4	P	52	68
	5	P	52	84
75	1	P	40	35
	2	P	50	45
	3	P	52	54
	4	P	52	68
	5	P	52	84
80	1	P	45	35
	2	P	50	45
	3	P	62	54
	4	P	62	68
	5	P	62	84
85	1	D	45	35
	2	P	50	45
	3	P	62	54
	4	P	62	68
	5	P	62	84
90	1	D	45	35
	2	P	60	45
	3	P	62	54
	4	P	68	68
	5	P	68	84
95	1	D	45	35
	2	P	60	45
	3	P	62	54
	4	P	68	68
	5	P	68	84
100	1	D	45	35
	2	P	60	45
	3	P	62	54
	4	P	70	50
	5	P	70	50
106	1	D	45	35
	2	D	60	45
	3	D	60	50
	4	P	68	50
	5	P	68	50
112	1	D	45	35
	2	D	60	45
	3	D	60	50
	4	P	68	50
	5	P	68	50
118	1	D	60	35
	2	D	60	45
	3	D	70	50
	4	P	70	50
	5	P	80	50
125	1	D	55	35
	2	D	60	45
	3	D	68	50
	4	D	68	50
	5	D	80	50

“PT” SPA-A

Diametro primitivo pitch diameter diamètre primitif Wirkdurchmesser dw [mm]	gole grooves gorges Rillen N°	forma size forme Ausführung fig.	M [mm]	L [mm]
132	1	D	55	35
	2	D	60	45
	3	D	68	50
	4	D	68	50
	5	D	80	50
140	1	D	60	35
	2	D	60	45
	3	D	68	50
	4	D	68	50
	5	D	80	50
150	1	D	60	40
	2	D	60	45
	3	D	68	50
	4	D	68	50
	5	D	80	50
160	1	D	60	40
	2	D	60	45
	3	D	68	50
	4	D	80	50
	5	D	80	50
170	1	D	60	40
	2	D	60	45
	3	D	68	50
	4	D	80	50
	5	D	80	50
180	1	D	65	40
	2	D	68	50
	3	D	68	50
	4	D	80	60
	5	D	80	65
190	1	D	65	40
	2	D	68	50
	3	D	68	50
	4	D	80	60
	5	D	80	65
200	1	D-6F	65	40
	2	D-6F	68	50
	3	D-8F	75	50
	4	D	88	60
	5	D	88	65
224	1	D-6F	65	40
	2	D-6F	68	50
	3	D-6F	75	50
	4	D-6F	88	60
	5	D-6F	88	65
236	1	D-6F	68	40
	2	D-6F	68	50
	3	D-6F	75	50
	4	D-8F	88	60
	5	D-8F	88	65
250	1	3R	75	50
	2	3R	75	50
	3	3R	75	50
	4	3R	88	60
	5	3R	96	65
280	1	3R	68	50
	2	3R	75	50
	3	3R	75	50
	4	3R	88	60
	5	3R	96	65
300	1	3R	75	50
	2	3R	75	50
	3	3R	88	60
	4	3R	88	60
	5	3R	96	70

“PT” SPA-A

W: see Tab. 1

Diametro primitivo pitch diameter diamètre primitif Wirkdurchmesser dw [mm]	gole grooves gorges Rillen N°	forma size forme Ausführung fig.	M [mm]	L [mm]
315	2	3R	75	50
	3	3R	88	60
	4	3R	88	60
	5	3R	96	70
	355	2	3R	88
3	3R	88	60	
4	3R	88	60	
5	3R	96	70	
400	2	6R	88	60
	3	6R	96	65
	4	6R	96	65
	5	6R	96	70
450	2	6R	88	60
	3	6R	96	65
	4	6R	104	70
	5	6R	104	70
	500	2	6R	88
3		6R	96	65
4		6R	104	70
5		6R	104	70
560		2	6R	88
	3	6R	96	65
	4	6R	104	70
	5	6R	104	70
	630	3	6R	104
4		6R	112	70
5		6R	120	75
800	3	6R	128	100
	4	6R	128	100
	5	6R	145	110

* Attenzione: il diametro fondo gola è di 32 mm
Caution: diameter of bottom groove is 32 mm.
Attention: le diamètre de fond de gorge est 32 mm.
Achtung: Rillenbodendurchmesser 32 mm.

** Attenzione: il diametro fondo gola è di 38 mm
Caution: diameter of bottom groove is 38 mm.
Attention: le diamètre de fond de gorge est 38 mm.
Achtung: Rillenbodendurchmesser 38 mm.

“PT” SPB-B-5V

Diametro primitivo pitch diameter diamètre primitif Wirkdurchmesser dw [mm]	gole grooves gorges Rillen N°	forma size forme Ausführung fig.	M [mm]	L [mm]
60	1	P	40*	35
	2	P	40*	48
71	1	P	45**	35
	2	P	45**	48
	3	P	45**	67
75	1	P	45	35
	2	P	45	48
	3	P	45	67
80	1	P	50	35
	2	P	50	48
	3	P	50	67
	4	P	52	86
	5	P	58	105
85	1	P	50	35
	2	P	50	48
	3	P	52	67
	4	P	58	86
	5	P	58	105
90	1	P	50	35
	2	P	50	48
	3	P	58	67
	4	P	65	50
	5	P	65	50
95	1	P	52	35
	2	P	55	48
	3	P	58	67
	4	P	65	50
	5	P	65	50
100	1	P	52	35
	2	P	55	48
	3	P	58	67
	4	P	65	50
	5	P	65	50
106	1	P	50	35
	2	P	55	48
	3	P	65	50
	4	P	65	50
	5	P	67	50
112	1	D	55	35
	2	D	60	48
	3	P	65	50
	4	P	75	50
	5	P	75	50
118	1	D	55	35
	2	D	60	48
	3	P	75	50
	4	P	75	50
	5	P	75	50
125	1	D	55	35
	2	D	60	48
	3	D	75	50
	4	D	75	50
	5	D	75	50
	6	P	80	60
132	1	D	60	35
	2	D	60	50
	3	D	75	50
	4	D	80	50
	5	D	80	60
	6	D	80	60
140	1	D	60	35
	2	D	65	50
	3	D	75	50
	4	D	80	50
	5	D	80	60
	6	D	80	60

“PT” SPB-B-5V

Diametro primitivo pitch diameter diamètre primitif Wirkdurchmesser dw [mm]	gole grooves gorges Rillen N°	forma size forme Ausführung fig.	M [mm]	L [mm]
150	1	D	60	40
	2	D	65	50
	3	D	75	50
	4	D	80	50
	5	D	80	60
	6	D	88	60
160	1	D	65	40
	2	D	68	50
	3	D	80	50
	4	D	88	60
	5	D	88	60
	6	D	88	65
170	1	D	65	40
	2	D	68	50
	3	D	80	50
	4	D	88	60
	5	D	88	60
	6	D	104	65
180	1	D	65	40
	2	D	68	50
	3	D	80	50
	4	D	88	60
	5	D	88	70
	6	D	104	70
190	1	D	65	40
	2	D	68	50
	3	D	80	50
	4	D	88	60
	5	D	88	70
	6	D	104	70
200	1	D	68	40
	2	D	68	50
	3	D	80	50
	4	D	88	60
	5	D	88	70
	6	D	104	80
212	1	D-6F	68	45
	2	D-6F	68	50
	3	D	80	50
	4	D	88	60
	5	D	88	70
	6	D	104	80
224	1	D-6F	68	45
	2	D-6F	75	50
	3	D-6F	80	50
	4	D	88	60
	5	D	96	70
	6	D	104	80
236	1	D-6F	68	45
	2	D-6F	75	50
	3	D-6F	80	60
	4	D-6F	88	65
	5	D-6F	96	75
	6	D	104	80
250	1	3R	70	45
	2	3R	75	50
	3	3R	88	60
	4	3R	96	65
	5	D-6F	104	75
	6	D-6F	104	80
280	1	3R	75	45
	2	3R	75	50
	3	3R	88	60
	4	3R	96	65
	5	3R	104	75
	6	3R	104	80

“PT” SPB-B-5V

W: see Tab. 1

Diametro primitivo pitch diameter diamètre primitif Wirkdurchmesser dw [mm]	gole grooves gorges Rillen N°	forma size forme Ausführung fig.	M [mm]	L [mm]
300	1	3R	75	50
	2	3R	80	50
	3	3R	88	60
	4	3R	96	65
	5	3R	104	75
	6	3R	104	80
315	2	3R	88	60
	3	3R	88	60
	4	3R	96	65
	5	3R	104	75
	6	3R	120	90
	355	2	3R	88
3		3R	96	60
4		3R	96	65
5		3R	104	75
6		3R	120	90
400		2	6R	88
	3	6R	96	65
	4	6R	104	75
	5	6R	112	85
	6	6R	120	100
	450	2	6R	88
3		6R	96	65
4		6R	104	75
5		6R	112	85
6		6R	120	100
500		2	6R	96
	3	6R	104	75
	4	6R	112	85
	5	6R	120	90
	6	6R	128	105
	560	2	6R	96
3		6R	104	75
4		6R	112	85
5		6R	120	90
6		6R	128	105
630		2	6R	104
	3	6R	120	90
	4	6R	128	105
	5	6R	145	115
	6	6R	145	115
	710	2	6R	96
3		6R	112	75
4		6R	120	90
5		6R	128	105
6		6R	145	115
800		2	6R	104
	3	6R	120	90
	4	6R	128	105
	5	6R	145	115
	6	6R	145	115

* Attenzione: il diametro fondo gola è di 32 mm
Caution: diameter of bottom groove is 32 mm.
Attention: le diamètre de fond de gorge est 32 mm.
Achtung: Rillenbodendurchmesser 32 mm.

** Attenzione: il diametro fondo gola è di 38 mm
Caution: diameter of bottom groove is 38 mm.
Attention: le diamètre de fond de gorge est 38 mm.
Achtung: Rillenbodendurchmesser 38 mm.

“PT” C

Diametro primitivo pitch diameter diamètre primitif Wirkdurchmesser dw [mm]	gole grooves gorges Rillen N°	forma size forme Ausführung fig.	M [mm]	L [mm]
140	1	D	62	58
	2	D	70	58
	3	D	74	70
	4	D	74	74
	5	D	74	78
	6	D	75	78
150	1	D	62	59
	2	D	70	61
	3	D	70	70
	4	D	74	74
	5	D	75	78
	6	D	78	78
160	1	D	62	59
	2	D	70	61
	3	D	76	70
	4	D	78	74
	5	D	78	78
	6	D	82	78
170	1	D	70	60
	2	D	70	62
	3	D	76	74
	4	D	82	76
	5	D	82	78
	6	D	87	80
180	1	D	70	60
	2	D	70	60
	3	D	78	72
	4	D	82	74
	5	D	82	80
	6	D	87	72
190	1	D	70	60
	2	D	74	60
	3	D	78	72
	4	D	82	74
	5	D	84	80
	6	D	88	85
200	1	D	71	60
	2	D	73	72
	3	D	83	76
	4	D	90	88
	5	D	92	92
	6	D	96	98
224	1	D	71	63
	2	D	76	68
	3	D	83	76
	4	D	93	90
	5	D	93	92
	6	D	98	98
250	1	D	82	63
	2	D	82	71
	3	D	90	80
	4	D	95	90
	5	D	100	96
	6	D	102	102

“PT” C

W: see Tab. 1

Diametro primitivo pitch diameter diamètre primitif Wirkdurchmesser dw [mm]	gole grooves gorges Rillen N°	forma size forme Ausführung fig.	M [mm]	L [mm]
280	1	D	82	64
	2	D	82	74
	3	D	90	80
	4	D	95	90
	5	D	100	96
	6	R	102	102
300	1	R	85	65
	2	R	90	75
	3	R	90	80
	4	R	105	90
	5	R	105	95
	6	R	105	107
315	1	R	85	65
	2	R	90	75
	3	R	90	80
	4	R	105	90
	5	R	105	95
	6	R	105	107
355	1	R	100	70
	2	R	105	75
	3	R	105	80
	4	R	115	90
	5	R	115	95
	6	R	115	110
400	1	R	100	70
	2	R	105	75
	3	R	105	80
	4	R	120	90
	5	R	120	95
	6	R	120	110
450	1	R	105	70
	2	R	110	75
	3	R	110	80
	4	R	120	95
	5	R	120	100
	6	R	120	110
500	1	R	110	75
	2	R	115	80
	3	R	115	85
	4	R	120	100
	5	R	125	110
	6	R	125	115
560	1	R	110	75
	2	R	115	80
	3	R	115	85
	4	R	125	100
	5	R	125	110
	6	R	125	115
630	1	R	115	75
	2	R	120	80
	3	R	120	95
	4	R	130	100
	5	R	130	110
	6	R	130	115

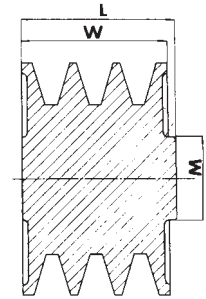

P

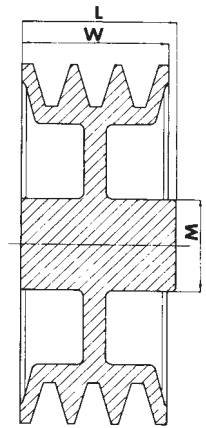

D

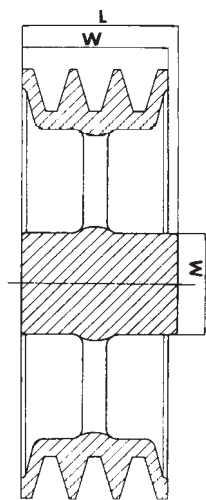

R

Pulegge PBT

PBT pulleys

Poulies PBT

PBT
Keilriemenscheiben

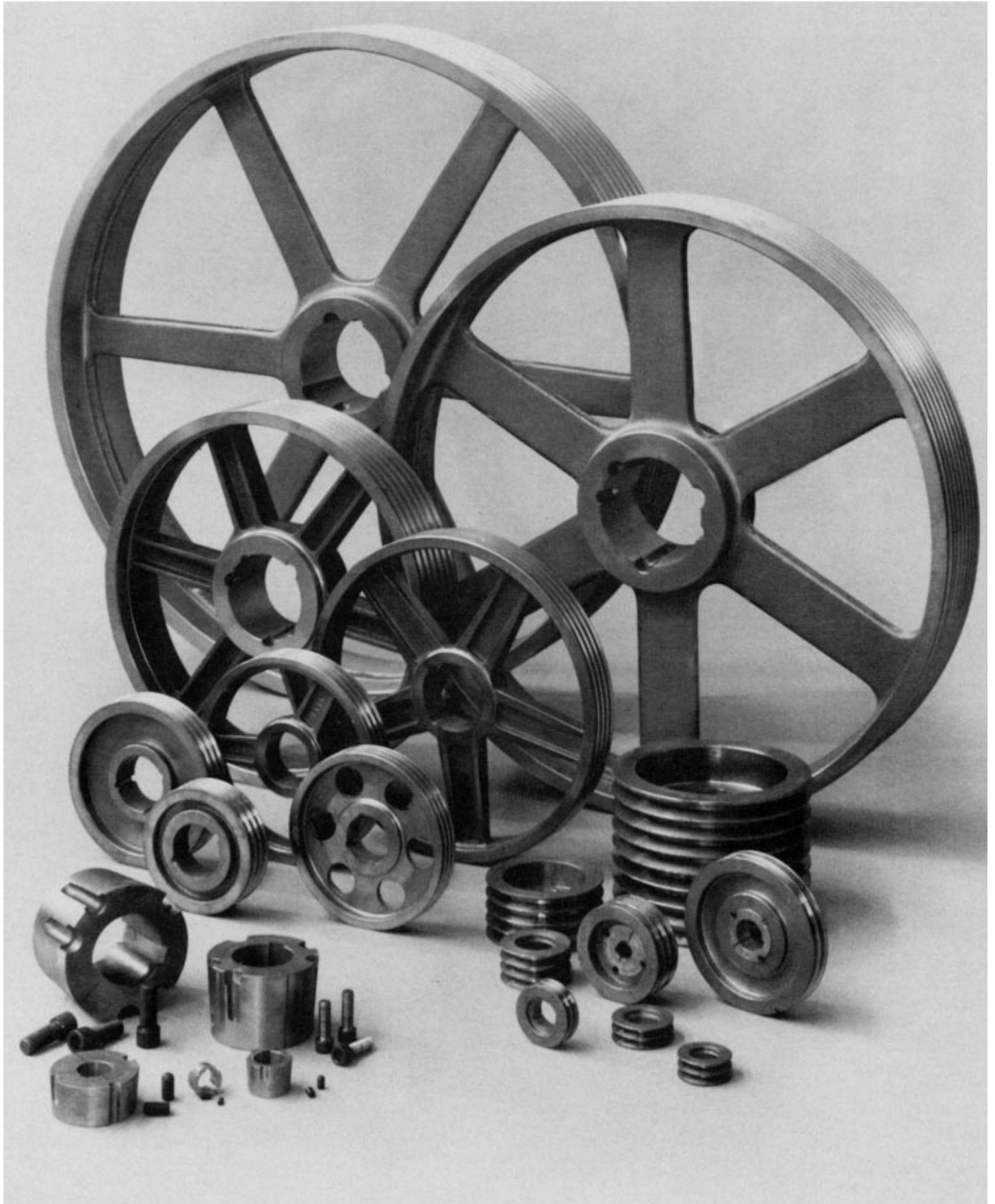

**Dimensioni delle pulegge
PBT per bussole coniche
SER-SIT®**

**Dimensions of PBT
pulley for SER-SIT®
taper bush**

**Dimensions
des poulies PBT
pour moyeu amovible
SER-SIT®**

**PBT Scheibenabmessun-
gen zur Montage mit
SER-SIT® Spannbuchse**

“PBT” SPZ-Z-3V

W: see Tab. 1

dw [mm]	N°	TB	min-max d [mm]	fig.	M [mm]	L [mm]	Z [mm]	U [mm]	[kg]
63	1	1108	11-28	1	58	21	5	—	0,27
	2	1108	11-28	10	—	21	7	38	0,32
	3	1108	11-28	10	—	21	19	38	0,45
67	1	1108	11-28	1	58	21	5	—	0,30
	2	1108	11-28	10	—	21	7	40	0,39
	3	1108	11-28	10	—	21	19	40	0,53
71	1	1108	11-28	1	58	21	5	—	0,35
	2	1108	11-28	10	—	21	7	44	0,47
	3	1108	11-28	10	—	21	19	44	0,64
75	1	1108	11-28	1	58	21	5	—	0,40
	2	1210	12-32	10	—	26	2	48	0,47
	3	1210	12-32	10	—	26	14	48	0,64
	4	1210	12-32	10	—	26	26	48	0,80
80	1	1210	12-32	1	75	26	10	—	0,48
	2	1210	12-32	10	—	26	2	53	0,54
	3	1210	12-32	10	—	26	14	53	0,77
	4	1210	12-32	10	—	26	26	53	0,94
85	1	1210	12-32	1	80	26	10	—	0,54
	2	1610	12-42	10	—	26	2	58	0,54
	3	1610	12-42	10	—	26	14	58	0,77
	4	1610	12-42	10	—	26	26	58	0,97
	5	1610	12-42	10	—	26	38	58	1,08
90	1	1210	12-32	1	80	26	10	—	0,62
	2	1610	12-42	10	—	26	2	63	0,68
	3	1610	12-42	10	—	26	14	63	0,86
	4	1610	12-42	10	—	26	26	63	1,10
	5	1610	12-42	10	—	26	38	63	1,26
	*6	1610	12-42	10	—	26	50	63	1,45
95	1	1210	12-32	1	80	26	10	—	0,71
	2	1610	12-42	10	—	26	2	68	1,11
	3	1610	12-42	10	—	26	14	68	1,18
	4	1610	12-42	10	—	26	26	68	1,22
	5	1610	12-42	10	—	26	38	68	1,54
	*6	1610	12-42	10	—	26	50	68	1,71
100	1	1210	12-32	1	80	26	10	—	0,90
	2	1610	12-42	10	—	26	2	73	0,94
	3	1610	12-42	10	—	26	14	73	1,40
	4	1610	12-42	10	—	26	26	73	1,40
	5	2012	15-50	10	—	31	33	73	1,47
	*6	2012	14-50	10	—	31	45	73	1,74
106	1	1210	12-32	1	80	26	10	—	0,96
	2	1610	12-42	2	—	26	2	78	1,10
	3	1615	12-42	1	82	41	1	—	1,67
	4	2012	15-50	10	—	31	21	78	1,46
	5	2012	15-50	10	—	31	33	78	1,66
	*6	2012	14-50	10	—	31	45	78	1,83
112	1	1610	12-42	1	80	26	10	—	0,98
	2	1610	12-42	10	—	26	2	85	1,32
	3	2012	15-50	10	—	31	9	85	1,64
	4	2012	15-50	10	—	31	21	85	1,70
	5	2012	15-50	10	—	31	33	85	1,97
	*6	2012	14-50	10	—	31	45	85	2,20
118	1	1610	12-42	1	80	26	10	—	1,24
	2	1610	12-42	2	—	26	2	93	1,47
	3	2012	15-50	10	—	31	9	93	1,92
	4	2012	15-50	2	—	31	21	93	1,98
	5	2012	15-50	2	—	31	33	93	2,14
	*6	2012	14-50	2	—	31	45	93	2,30
125	1	1610	12-42	1	88	26	10	—	1,28
	2	1610	12-42	10	—	26	2	98	1,70
	3	2012	15-50	2	—	31	9	98	1,98
	4	2012	15-50	2	—	31	21	98	2,28
	5	2012	15-50	10	—	31	33	98	2,57
	*6	2517	18-65	10	—	46	30	98	2,70
132	1	1610	12-42	4	90	26	10	105	1,30
	2	1610	12-42	5	90	26	2	105	1,80
	3	2012	15-50	2	—	31	9	105	2,24
	4	2012	15-50	2	—	31	21	105	2,60
	5	2517	18-65	2	—	46	18	105	2,86
	*6	2517	18-65	2	—	46	30	105	3,10
140	1	1610	12-42	4	90	26	10	113	1,38
	2	1610	12-42	5	90	26	2	113	1,80
	3	2012	15-50	2	—	31	9	113	2,68
	4	2012	15-50	2	—	31	21	113	2,98
	5	2517	18-65	2	—	46	18	113	3,40
	*6	2517	18-65	2	—	46	30	113	3,75

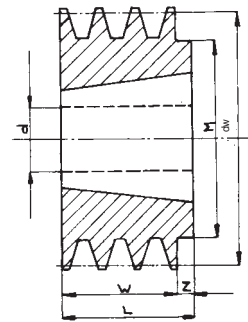

fig. 1

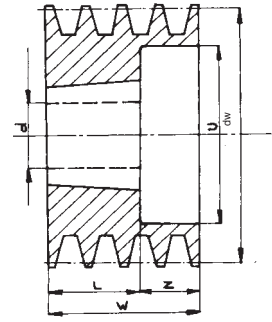

fig. 2

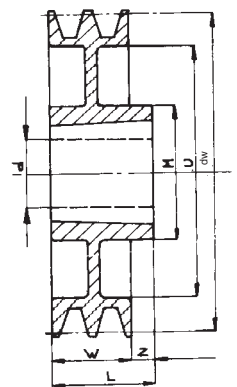

fig. 4

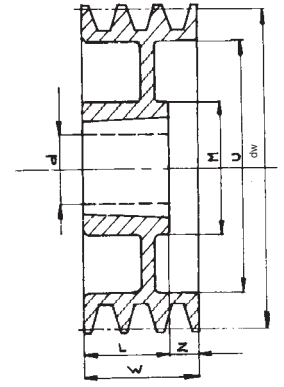

fig. 5

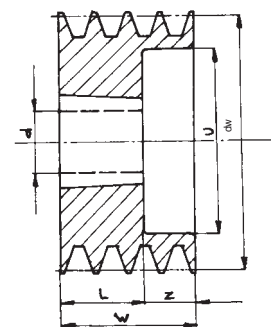

fig. 10

* = Salvo venduto
* = Up to sold out

* = Sauf vendu
* = Solange vorrat reicht



“PBT” SPZ-Z-3V

dw [mm]	N°	TB	min-max d [mm]	fig.	M [mm]	L [mm]	Z [mm]	U [mm]	[kg]
150	1	1610	12-42	4	90	26	10	123	1,52
	2	2012	15-50	4	110	31	3	123	2,49
	3	2012	15-50	5	110	31	9	123	2,84
	4	2517	18-65	2	-	46	6	123	3,76
	5	2517	18-65	2	-	46	18	123	4,14
	*6	2517	18-65	2	-	46	30	123	4,35
160	1	1610	12-42	4	90	26	10	133	1,65
	2	2012	15-50	4	110	31	3	133	2,42
	3	2012	15-50	5	110	31	9	133	2,92
	4	2517	18-65	5	120	46	6	133	4,20
	5	2517	18-65	5	120	46	18	133	4,40
	*6	2517	18-55	5	120	46	30	133	4,68
180	1	1610	12-42	4	90	26	10	153	1,72
	2	2012	15-50	4	110	31	3	153	2,80
	3	2012	15-50	5	110	31	9	153	3,42
	4	2517	18-65	5	120	46	6	153	4,10
	5	2517	18-65	5	120	46	18	153	4,78
	*6	2517	18-55	5	120	46	30	153	5,00
200	1	2012	15-50	4	110	31	15	173	2,51
	2	2012	15-50	4	110	31	3	173	3,27
	3	2012	15-50	6	110	31	4,5	173	3,93
	4	2517	18-65	6	120	46	3	173	4,82
	5	2517	18-65	6	120	46	9	173	5,20
	*6	2517	18-65	6	120	46	15	173	5,40
224	1	2012	15-50	3	110	31	7,5	197	2,78
	2	2012	15-50	4	110	31	3	197	3,80
	3	2012	15-50	5	110	31	9	197	4,60
	4	2517	18-65	5	120	46	6	197	5,56
	5	2517	18-65	5	120	46	18	197	5,90
	*6	2517	18-65	5	120	46	30	197	6,60
250	1	2012	15-50	3	110	31	7,5	223	3,61
	2	2012	15-50	3	110	31	1,5	223	3,70
	3	2012	15-50	6	110	31	4,5	223	4,82
	4	2517	18-65	6	120	46	3	223	5,96
	5	2517	18-65	6	120	46	9	223	7,00
	*6	2517	18-65	6	120	46	15	223	7,60
280	1	2012	15-50	3	110	31	7,5	253	3,18
	2	2012	15-50	7	110	31	3	253	4,20
	3	2517	18-65	7	120	46	6	253	6,66
	4	2517	18-65	8	120	46	6	253	7,30
	5	2517	18-65	8	120	46	18	253	8,84
	*6	2517	18-55	8	120	46	30	253	9,02
315	1	2012	15-50	3	110	31	7,5	288	3,56
	2	2012	15-50	3	110	31	1,5	288	4,85
	3	2517	18-65	3	120	46	3	288	6,34
	4	2517	18-65	9	120	46	3	288	7,36
	5	2517	18-65	9	120	46	9	288	8,26
	*6	2517	18-65	9	120	46	15	288	8,70
355	1	2012	15-50	7	110	31	15	328	5,46
	2	2012	15-50	7	110	31	3	328	5,95
	3	2517	18-65	7	120	46	6	328	9,32
	4	2517	18-65	8	120	46	6	328	8,10
	5	2517	18-65	8	120	46	18	328	14,06
	*6	2517	18-65	8	120	46	30	328	15,00
400	1	2012	15-50	3	110	31	7,5	373	5,52
	2	2517	18-65	3	120	46	9	373	7,41
	3	2517	18-65	3	120	46	3	373	9,81
	4	2517	18-65	9	120	46	3	373	10,31
	5	3020	25-75	9	146	51	6,5	373	12,62
	*6	3020	25-75	9	146	51	12,5	373	14,10
450	1	2517	18-65	7	120	46	30	423	6,20
	2	2517	18-65	7	120	46	18	423	8,00
	3	2517	18-65	7	120	46	6	423	11,30
	4	3020	25-75	8	146	51	1	423	16,73
	5	3020	25-75	9	146	51	13	423	17,66
	*6	3020	25-75	8	140	76	-	423	18,20
500	1	2517	18-65	7	120	46	30	473	8,84
	2	2517	18-65	3	120	46	9	473	10,66
	3	2517	18-65	3	120	46	3	473	13,82
	4	3020	25-75	9	146	51	1	473	16,58
	5	3020	25-75	9	146	51	6,5	473	17,26
	*6	3020	25-75	9	140	76	-	473	19,00
630	1	2517	18-65	7	120	46	30	603	15,60
	2	2517	18-65	7	120	46	18	603	18,90
	3	2517	18-65	3	120	46	3	603	24,50
	4	3020	25-75	9	146	51	1	603	29,38
	5	3020	25-75	9	146	51	6,5	603	30,60

“PBT” SPA-A

W: see Tab. 1

dw [mm]	N°	TB	min-max d [mm]	fig.	M [mm]	L [mm]	Z [mm]	U [mm]	[kg]
71	1	1108	11-28	1	60	22	2	-	0,08
	2	1108	11-28	10	-	22	13	40	0,08
	3	1108	11-28	10	-	22	28	40	0,08
75	1	1108	11-28	1	60	22	2	-	0,08
	2	1108	11-28	10	-	22	13	44	0,08
	3	1108	11-28	10	-	22	28	44	0,08
80	1	1210	12-32	1	84	25	5	-	0,08
	2	1210	12-32	10	-	25	10	50	0,08
	3	1210	12-32	10	-	25	25	50	0,08
85	1	1210	12-32	1	88	25	5	-	0,08
	2	1210	12-32	10	-	25	10	55	0,08
	3	1210	12-32	10	-	25	25	55	0,08
90	1	1210	12-32	1	80	26	6	-	0,73
	2	1610	12-42	10	-	26	9	57	0,90
	3	1610	12-42	10	-	26	24	57	1,04
	4	1610	12-42	11	-	26	19,5	57	1,21
95	1	1210	12-32	1	80	26	6	-	0,78
	2	1610	12-42	10	-	26	9	63	1,10
	3	1610	12-42	10	-	26	24	63	1,26
	4	1610	12-42	11	-	26	19,5	63	1,58
100	1	1610	12-42	1	90	26	6	-	0,84
	2	1610	12-42	10	-	26	9	68	1,20
	3	1610	12-42	2	-	26	24	68	1,40
	4	1610	12-42	2	-	26	39	68	1,70
	5	1610	12-42	11	-	26	27	68	2,04
106	1	1610	12-42	1	90	26	6	-	0,98
	2	1610	12-42	10	-	26	9	73	1,25
	3	1610	12-42	2	-	26	24	73	1,59
	4	2012	15-50	10	-	31	34	73	1,74
	5	2012	15-50	10	-	31	49	73	2,13
112	1	1610	12-42	1	90	26	6	-	1,14
	2	1610	12-42	10	-	26	9	79	1,46
	3	2012	15-50	10	-	31	19	79	1,85
	4	2012	15-50	10	-	31	34	79	2,02
	5	2012	15-50	10	-	31	49	79	2,38
118	1	1610	12-42	1	90	26	6	-	1,26
	2	1610	12-42	10	-	26	9	85	1,68
	3	2012	15-50	2	-	31	19	85	1,92
	4	2012	15-50	2	-	31	34	85	2,29
	5	2012	15-50	2	-	31	49	85	2,67
125	1	1610	12-42	1	90	26	6	-	1,45
	2	1610	12-42	10	-	26	9	92	1,93
	3	2012	15-50	2	-	31	19	92	2,28
	4	2012	15-50	2	-	31	34	92	2,70
	5	2012	15-50	11	-	31	24,5	92	3,10
132	1	1610	12-42	1	90	26	6	-	1,64
	2	2012	15-50	10	-	31	4	99	2,08
	3	2012	15-50	2	-	31	19	99	2,62
	4	2517	18-65	2	-	46	19	99	3,10
	5	2517	18-65	11	-	46	17	99	3,40
140	1	1610	12-42	4	90	26	6	107	1,66
	2	2012	15-50	2	-	31	4	107	2,50
	3	2517	18-65	10	-	46	4	107	3,04
	4	2517	18-65	2	-	46	19	107	3,53
	5	2517	18-65	11	-	46	17	107	4,20
150	1	1610	12-42	4	90	26	6	117	1,73
	2	2012	15-50	2	-	31	4	117	2,96
	3	2517	18-65	10	-	46	4	117	3,75
	4	2517	18-65	2	-	46	19	117	4,30
	5	2517	18-65	11	-	46	17	117	4,90
160	1	1610	12-42	4	90	26	6	127	2,02
	2	2012	15-50	5	110	31	4	127	3,28
	3	2517	18-65	10	-	46	4	127	4,55
	4	2517	18-65	2	-	46	19	127	5,08
	5	2517	18-65	11	-	46	17	127	5,57
170	1	1610	12-42	4	90	26	6	137	2,06
	2	2012	15-50	5	110	31	4	137	3,30
	3	2517	18-65	5	120	46	4	137	5,29
	4	2517	18-65	5	120	46	19	137	5,90
	5	2517	18-65	6	120	46	17	137	6,60
180	1	1610	12-42	4	90	26	6	147	2,27
	2	2012	15-50	5	110	31	4	147	3,20
	3	2517	18-65	5	120	46	4	147	4,90
	4	2517	18-65	5	120	46	19	147	5,70
	5	3020	25-75	11	-	51	14,5	147	6,78

* = Salvo venduto
* = Up to sold out

* = Sauf vendu
* = Solange vorrat reicht

“PBT” SPA-A

W: see Tab. 1

dw [mm]	N°	TB	min-max d [mm]	fig.	M [mm]	L [mm]	Z [mm]	U [mm]	[kg]
190	1	2012	15-50	4	110	31	11	157	2,61
	2	2012	15-50	5	110	31	4	157	3,48
	3	2517	18-65	5	120	46	4	157	4,82
	4	2517	18-65	5	120	46	19	157	5,68
	5	3020	25-75	11	-	51	14,5	157	7,93
200	1	2012	15-50	4	110	31	11	167	3,16
	2	2517	18-65	4	120	46	11	167	4,70
	3	2517	18-65	5	120	46	4	167	5,36
	4	3020	25-75	5	146	51	14	167	8,20
	5	3020	25-75	6	146	51	14,5	167	8,40
224	1	2012	15-50	4	110	31	11	191	3,42
	2	2517	18-65	4	120	46	11	191	5,68
	3	2517	18-65	6	120	46	2	191	5,90
	4	3020	25-75	5	146	51	14	191	8,20
	5	3020	25-75	5	146	51	29	191	9,06
236	1	2012	15-50	4	110	31	11	203	3,64
	2	2517	18-65	4	120	46	11	203	5,09
	3	2517	18-65	5	120	46	4	203	6,30
	4	3020	25-75	6	146	51	7	203	8,24
	5	3020	25-75	6	146	51	14,5	203	9,46
250	1	2012	15-50	4	110	31	11	217	4,14
	2	2517	18-65	4	120	46	11	217	6,03
	3	2517	18-65	6	120	46	2	217	7,92
	4	3020	25-75	6	146	51	7	217	8,28
	5	3020	25-75	9	146	51	14,5	217	10,15
280	1	2012	15-50	7	110	31	11	247	4,40
	2	2517	18-65	7	120	46	11	247	6,70
	3	2517	18-65	6	120	46	2	247	7,90
	4	3020	25-75	6	146	51	7	247	11,15
	5	3020	25-75	9	146	51	14,5	247	11,20
315	1	2012	15-50	7	110	31	11	282	4,40
	2	2517	18-65	7	120	46	11	282	6,56
	3	3020	25-75	3	146	51	0,5	282	8,56
	4	3020	25-75	9	146	51	7	282	9,64
	5	3020	25-75	9	146	51	14,5	282	13,00
355	1	2012	15-50	7	110	31	11	322	5,50
	2	2517	18-65	7	120	46	11	322	7,97
	3	3020	25-75	3	146	51	0,5	322	10,40
	4	3020	25-75	9	146	51	7	322	14,44
	5	3020	25-75	9	146	51	14,5	322	15,66
400	1	2012	15-50	7	110	31	11	367	6,72
	2	2517	18-65	7	120	46	11	367	9,08
	3	3020	25-75	3	146	51	0,5	367	12,28
	4	3020	25-75	9	146	51	7	367	15,40
	5	3020	25-75	9	146	51	14,5	367	17,02
450	1	2517	18-65	7	120	46	26	417	8,20
	2	2517	18-65	7	120	46	11	417	10,52
	3	3020	25-75	3	146	51	0,5	417	13,42
	4	3020	25-75	9	146	51	7	417	16,82
	5	3020	25-75	9	146	51	14,5	417	20,50
500	1	2517	18-65	7	120	46	26	467	10,48
	2	2517	18-65	7	120	46	11	467	12,90
	3	3020	25-75	3	146	51	0,5	467	16,90
	4	3020	25-75	9	146	51	7	467	19,80
	5	3020	25-75	9	146	91	14,5	467	23,10
560	1	3020	25-75	7	146	51	31	527	14,80
	2	3020	25-75	7	146	51	16	527	19,00
	3	3020	25-75	7	146	51	1	527	23,94
	4	3020	25-75	8	146	51	14	527	32,00
	5	3525	45-90	7	178	91	11	527	40,00
630	3	3020	25-75	7	146	51	31	597	17,00
	4	3020	25-75	7	146	51	16	597	21,52
	4	3020	25-75	7	146	51	1	597	25,78
	4	3020	25-75	8	146	51	14	597	32,78
	5	3525	45-90	7	178	91	11	597	44,60
800	3	3535	45-90	7	178	91	41	767	41,00
	4	3535	45-90	7	178	91	26	767	50,00
	5	3535	45-90	7	178	91	11	767	52,50
1000	3	3525	45-90	7	178	91	41	967	50,00
	4	4040	55-100	7	215	101	36	967	68,00
	5	4040	55-100	7	215	101	21	967	74,00

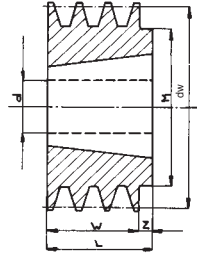

fig. 1

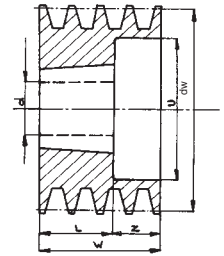

fig. 2

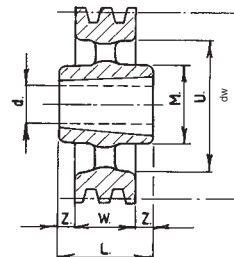

fig. 3

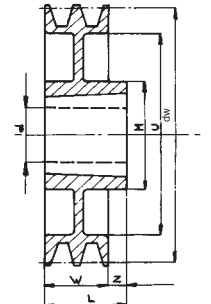

fig. 4

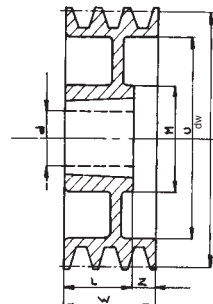

fig. 5

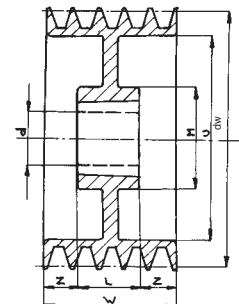

fig. 6

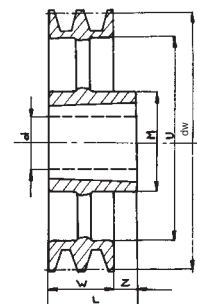

fig. 7

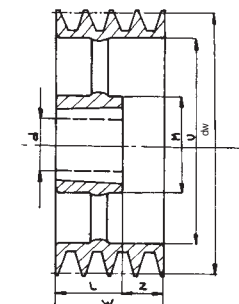

fig. 8

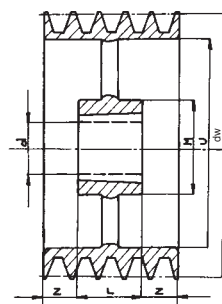

fig. 9

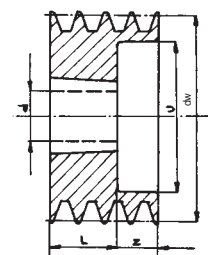

fig. 10

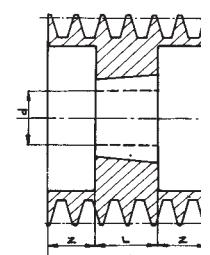

fig. 11

“PBT” SPB-B-5V

dw [mm]	N°	TB	min-max d [mm]	fig.	M [mm]	L [mm]	Z [mm]	U [mm]	[kg]
90	1	1210	15-50	1	—	25	—	—	0,75
	2	1210	15-50	10	—	25	19	47	1,15
	3	1210	15-50	10	—	25	28	47	1,55
100	1	1610	12-42	2	—	25	—	—	0,91
	2	1610	12-42	10	—	25	19	60	1,25
	3	1610	12-42	10	—	25	28	57	1,95
112	1	1610	12-42	2	—	25	—	—	1,15
	2	1610	12-42	10	—	25	19	69	1,68
	3	1610	12-42	10	—	25	28	69	2,25
118	1	1610	12-42	2	—	25	—	—	1,45
	2	1610	12-42	10	—	25	19	76	2,00
	3	1610	12-42	10	—	25	28	76	2,60
125	1	1610	12-42	2	—	25	—	—	1,70
	2	2012	15-50	2	—	32	12	86	2,10
	3	2012	15-50	2	—	32	31	86	2,44
	4	2012	15-50	11	—	32	50/25	86	2,94
132	1	1610	12-42	2	—	25	—	—	2,10
	2	2012	15-50	2	—	32	12	89	2,37
	3	2012	15-50	2	—	32	31	89	3,08
	4	2012	15-50	11	—	32	50/25	89	3,90
140	1	1610	12-42	1	—	25	—	—	2,06
	2	2012	15-50	2	—	31	13	100	2,70
	3	2012	15-50	2	—	31	32	100	3,40
	4	2517	18-65	11	—	46	18	100	3,80
	5	2517	18-65	11	—	46	27,5	100	4,50
	6	2517	18-65	11	—	46	37	100	5,40
150	1	1610	12-42	1	—	25	—	—	2,45
	2	2012	15-50	2	—	31	13	110	3,30
	3	2517	18-65	2	—	46	17	110	4,01
	4	2517	18-65	11	—	46	18	110	4,86
	5	2517	18-65	11	—	46	27,5	110	5,50
	6	2517	18-65	11	—	46	37	110	6,24
160	1	1610	12-42	1	—	25	—	—	2,87
	2	2012	15-50	2	—	31	13	120	3,86
	3	2517	18-65	2	—	46	17	120	4,96
	4	2517	18-65	11	—	46	18	120	5,72
	5	2517	18-65	11	—	46	27,5	120	6,39
	6	3020	25-75	11	—	51	34,5	120	7,22
	7	3020	25-75	11	—	51	53,5	120	7,92
	8	3020	25-75	11	—	51	53,5	120	7,92
170	1	1610	12-42	1	—	25	—	—	3,31
	2	2012	15-50	2	—	31	13	130	4,46
	3	2517	18-65	2	—	46	17	130	5,76
	4	2517	18-65	11	—	46	18	130	6,80
	5	3020	25-75	11	—	51	25	130	6,60
	6	3020	25-75	11	—	51	34,5	130	7,64
	7	3020	25-75	11	—	51	53,5	130	9,18
	8	3020	25-75	11	—	51	53,5	130	9,18
180	1	1610	12-42	1	—	25	—	—	3,98
	2	2517	18-65	4	120	46	2	140	4,86
	3	2517	18-65	5	120	46	17	140	5,86
	4	2517	18-65	6	120	46	18	140	7,66
	5	3020	25-75	11	—	51	25	140	7,80
	6	3020	25-75	11	—	51	34,5	140	8,52
	7	3020	25-75	11	—	51	53,5	140	9,94
	8	3020	25-75	11	—	51	53,5	140	9,94
190	1	2012	15-50	4	112	32	7	—	4,10
	2	2517	18-65	4	120	46	2	150	4,92
	3	2517	18-65	5	120	46	17	150	5,96
	4	2517	18-65	6	120	46	18	150	8,68
	5	3020	25-75	11	—	51	25	150	9,00
	6	3020	25-75	11	—	51	34,5	150	9,80
	7	3020	25-75	11	—	51	53,5	150	13,50
	8	3020	25-75	11	—	51	53,5	150	13,50
200	1	2012	15-50	4	112	32	7	—	4,10
	2	2517	18-65	4	120	46	2	160	5,30
	3	2517	18-65	5	120	46	17	160	6,35
	4	3020	25-75	6	146	51	15,5	160	9,45
	5	3020	25-75	6	146	51	25	160	10,52
	6	3020	25-75	6	146	51	34,5	160	11,00
	7	3020	25-75	6	146	51	34,5	160	11,00
	8	3535	45-90	11	—	91	33,5	160	15,28

“PBT” SPB-B-5V

W: see Tab. 1

dw [mm]	N°	TB	min-max d [mm]	fig.	M [mm]	L [mm]	Z [mm]	U [mm]	[kg]
212	2	2517	18-65	4	120	46	2	172	5,84
	3	2517	18-65	5	120	46	17	172	6,90
	4	3020	25-75	6	146	51	15,5	172	9,56
	5	3020	25-75	6	146	51	25	172	10,52
	6	3535	45-90	11	—	91	14,5	172	15,55
224	2	2517	18-65	4	120	46	2	184	5,94
	3	2517	18-65	5	120	46	17	184	7,38
	4	3020	25-75	6	146	51	15,5	184	9,56
	5	3020	25-75	6	146	51	25	184	12,38
	6	3535	45-90	11	—	91	14,5	184	17,00
236	2	2517	18-65	4	120	46	2	196	6,90
	3	2517	18-65	6	120	46	8,5	196	7,81
	4	3020	25-75	6	146	51	15,5	196	10,00
	5	3535	45-90	11	178	91	5	196	19,30
	6	3535	45-90	11	178	91	14,5	196	20,12
250	2	2517	18-65	4	120	46	2	210	6,90
	3	3020	25-75	5	146	51	12	210	9,04
	4	3020	25-75	6	146	51	15,5	210	11,10
	5	3535	45-90	6	178	91	5	210	19,63
	6	3535	45-90	6	178	91	14,5	210	21,00
280	2	2517	18-65	4	120	46	2	240	8,46
	3	3020	25-75	6	146	51	6	240	11,00
	4	3020	25-75	6	146	51	15,5	240	12,76
	5	3535	45-90	6	178	91	5	240	19,63
	6	3535	45-90	6	178	91	14,5	240	22,12
300	2	2517	18-65	4	120	46	2	260	9,19
	3	3020	25-75	5	146	51	12	260	14,94
	4	3535	45-90	4	178	91	9	260	21,16
	5	3535	45-90	5	178	91	10	260	24,10
	6	3535	45-90	5	178	91	29	260	27,44
315	2	2517	18-65	12	120	46	2	275	9,76
	3	3020	25-75	6	146	51	6	275	12,34
	4	3535	45-90	4	178	91	9	275	19,82
	5	3535	45-90	5	178	91	10	275	21,52
	6	3535	45-90	6	178	91	14,5	275	24,60
355	2	3020	25-75	3	146	51	3,5	315	10,37
	3	3020	25-75	9	146	51	6	315	13,10
	4	3535	45-90	7	178	91	9	315	20,48
	5	3535	45-90	8	178	91	10	315	24,20
	6	3535	45-90	8	178	91	29	315	27,00
400	2	3020	25-75	3	146	51	35	360	11,50
	3	3535	45-90	7	178	91	28	360	19,64
	4	3535	45-90	7	178	91	9	360	22,24
	5	3535	45-90	8	178	91	10	360	25,61
	6	3535	45-90	8	178	91	29	360	28,30
450	2	4040	55-100	9	267	101	28,5	360	34,70
	3	3020	25-75	7	146	51	7	410	14,50
	3	3535	45-90	7	178	91	28	410	22,94
	4	3535	45-90	7	178	91	9	410	25,70
	5	3535	45-90	8	178	91	10	410	29,00
500	2	4040	55-100	8	215	101	9	410	37,80
	3	4040	55-100	9	215	101	28,5	410	41,35
	2	3020	25-75	3	146	51	3,5	460	16,28
	3	3535	45-90	7	178	91	28	460	24,00
	4	3535	45-90	7	178	91	9	460	29,00
500	5	3535	45-90	8	178	91	10	460	33,80
	6	4040	55-100	8	215	101	19	460	41,50
	7	4040	55-100	9	215	101	28,5	460	48,00
	8	4040	55-100	9	215	101	28,5	460	48,00

“PBT” SPB-B-5V

W: see Tab. 1

dw [mm]	N°	TB	min-max d [mm]	fig.	M [mm]	L [mm]	Z [mm]	U [mm]	[kg]
560	2	3020	25-75	7	146	51	7	520	24,72
	3	3535	45-90	7	178	91	28	520	33,70
	4	3535	45-90	7	178	91	9	520	40,62
	5	3535	45-90	8	178	91	10	520	48,50
	6	4040	55-100	8	215	101	19	520	57,00
	8	4040	55-100	9	215	101	28,5	520	71,20
630	2	3535	45-90	7	178	91	47	590	27,00
	3	3535	45-90	7	178	91	28	590	33,04
	4	3535	45-90	7	178	91	9	590	41,50
	5	4040	55-100	8	215	101	-	590	53,00
	6	4040	55-100	8	215	101	19	590	62,00
	8	5050	70-125	9	267	126	16	590	90,00
710	2	3535	45-90	7	178	91	47	670	32,00
	3	3535	45-90	7	178	91	28	670	39,20
	4	3535	45-90	7	178	91	9	670	57,00
	5	4040	55-100	8	215	101	-	670	62,00
	6	4040	55-100	8	215	101	19	670	63,00
	8	5050	70-125	9	267	126	16	670	91,00
800	2	3535	45-90	7	178	91	47	760	50,50
	3	3535	45-90	7	178	91	28	760	47,00
	4	4040	55-100	7	215	101	19	760	68,00
	5	4040	55-100	8	215	101	-	760	75,50
	6	4040	55-100	8	215	101	19	760	93,00
	8	5050	70-125	9	267	126	16	760	98,00
900	3	3535	45-90	7	178	91	28	860	79,00
	4	4040	55-100	7	215	101	19	860	83,00
	5	4040	55-100	8	215	101	-	860	85,00
	6	4040	55-100	8	215	101	19	860	100,00
	8	5050	70-125	9	267	126	16	860	118,00
	1000	3	4040	55-100	7	215	101	38	958
4		4040	55-100	7	215	101	19	958	83,00
5		4040	55-100	8	215	101	-	958	88,00
6		4040	55-100	8	215	101	19	958	115,00
8		5050	70-125	9	267	126	16	958	137,00
1250		3	4040	55-100	7	215	101	38	1208
	4	4040	55-100	7	215	101	19	1208	117,00
	5	4040	55-100	8	215	101	-	1208	132,00
	6	5050	70-125	7	267	126	6	1208	150,00
	8	5050	70-125	9	267	126	16	1208	173,00

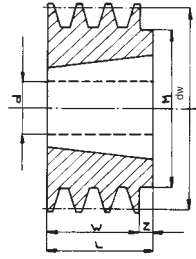

fig. 1

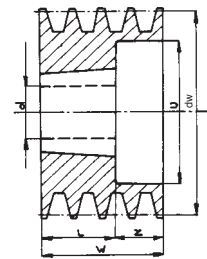

fig. 2

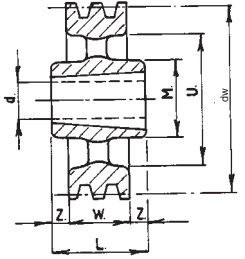

fig. 3

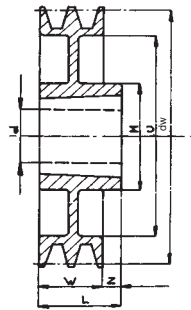

fig. 4

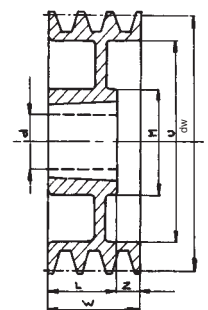

fig. 5

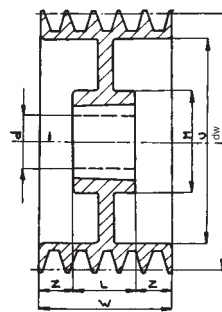

fig. 6

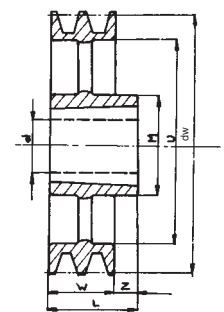

fig. 7

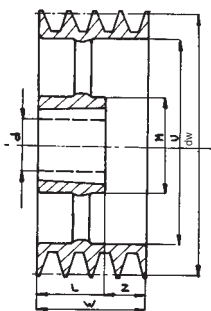

fig. 8

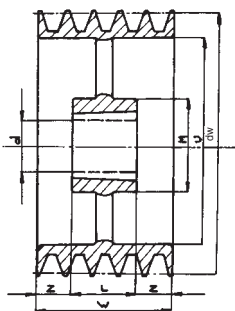

fig. 9

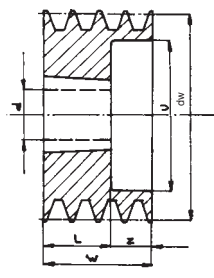

fig. 10

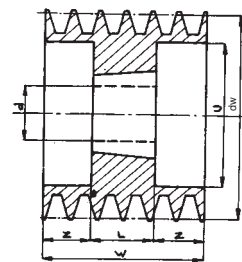

fig. 11

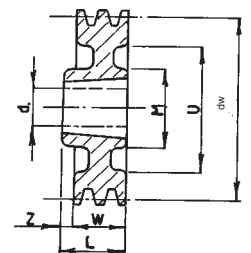

fig. 12

“PBT” SPC-C

dw [mm]	N°	TB	min-max d [mm]	fig.	M [mm]	L [mm]	Z [mm]	U [mm]	[kg]
224	3	3020	25-75	11	—	51	17	166	12,00
	4	3020	25-75	11	—	51	29,75	166	15,00
	5	3535	45-90	11	—	91	22,5	166	19,50
	6	3535	45-90	11	—	91	35,25	166	24,00
	8	3535	45-90	13*	—	91	43,5	166	26,32
236	3	3020	25-75	11	—	51	17	178	14,00
	4	3535	45-90	11	—	91	9,75	178	19,50
	5	3535	45-90	11	—	91	22,5	178	21,74
	6	3535	45-90	11	—	91	35,25	178	24,38
	8	3535	45-90	13*	—	91	43,5	178	29,64
250	3	3020	25-75	6	146	51	17	192	15,00
	4	3535	45-90	11	—	91	9,75	192	24,00
	5	3535	45-90	11	—	91	22,5	192	25,60
	6	3535	45-90	11	—	91	35,25	192	28,58
	8	3535	45-90	11	—	91	60,75	192	33,80
265	3	3020	25-75	6	146	51	17	207	15,00
	4	3535	45-90	6	178	91	9,75	207	26,00
	5	3535	45-90	6	178	91	22,5	207	38,36
	6	3535	45-90	6	178	91	35,25	207	31,70
	8	3535	45-90	6	178	91	60,75	207	37,66
280	3	3020	25-75	6	146	51	17	222	16,00
	4	3535	45-90	6	178	91	9,75	222	31,00
	5	3535	45-90	6	178	91	22,5	222	31,00
	6	3535	45-90	6	178	91	35,25	222	33,00
	8	4040	55-100	11	—	101	55,75	222	41,60
300	3	3535	45-90	14	178	91	3	242	25,00
	4	3535	45-90	6	178	91	9,75	242	32,00
	5	3535	45-90	6	178	91	22,5	242	32,00
	6	3535	45-90	6	178	91	35,25	242	33,30
	8	4040	55-100	6	215	101	55,75	242	47,00
315	3	3535	45-90	14	178	91	3	257	25,00
	4	3535	45-90	6	178	91	9,75	257	32,00
	5	3535	45-90	6	178	91	22,5	257	30,00
	6	4040	55-100	6	215	101	30,25	257	45,50
	8	4040	55-100	6	215	101	55,75	257	47,00
335	3	3535	45-90	14	178	91	3	277	25,00
	4	3535	45-90	6	178	91	9,75	277	32,00
	5	3535	45-90	6	178	91	22,5	277	34,32
	6	4040	55-100	6	215	101	30,25	277	45,00
	8	4040	55-100	6	215	101	55,75	277	50,50
355	3	3535	45-90	14	178	91	3	297	25,00
	4	3535	45-90	6	178	91	9,75	297	32,00
	5	4040	55-100	6	215	101	17,5	297	39,00
	6	4040	55-100	6	215	101	30,25	297	45,00
	8	4040	55-100	6	215	101	55,75	297	55,00
400	3	3535	45-90	3	178	91	3	342	33,00
	4	3535	45-90	9	178	91	9,75	342	34,00
	5	4040	55-100	9	215	101	17,5	342	45,50
	6	4040	55-100	9	215	101	30,25	342	47,00
	8	5050	70-125	6	267	126	43,25	342	76,00
450	3	3535	45-90	3	178	91	3	392	33,00
	4	3535	45-90	9	178	91	9,75	392	38,50
	5	4040	55-100	9	215	101	17,5	392	54,50
	6	4040	55-100	9	215	101	30,25	392	61,00
	8	5050	70-125	6	267	126	43,25	392	84,00
500	3	3535	45-90	3	178	91	3	442	40,00
	4	4040	55-100	9	215	101	4,75	442	53,50
	5	4040	55-100	9	215	101	17,5	442	60,00
	6	4040	55-100	9	215	101	30,25	442	69,00
	8	5050	70-125	9	267	126	43,25	442	90,00
560	3	3535	45-90	3	178	91	3	502	45,00
	4	4040	55-100	9	215	101	4,75	502	61,00
	5	4040	55-100	9	215	101	17,5	502	64,00
	6	5050	70-125	9	267	126	17,75	502	86,00
	8	5050	70-125	9	267	126	43,25	502	107,00

“PBT” SPC-C

W: see Tab. 1

dw [mm]	N°	TB	min-max d [mm]	fig.	M [mm]	L [mm]	Z [mm]	U [mm]	[kg]
630	3	4040	55-100	3	215	101	8	572	57,00
	4	4040	55-100	9	215	101	4,75	572	68,00
	5	5050	70-125	9	267	126	5	572	90,80
	6	5050	70-125	9	267	126	17,75	572	100,00
	8	5050	70-125	9	267	126	43,25	572	114,00
710	3	4040	55-100	3	215	101	8	652	67,00
	4	4040	55-100	9	215	101	4,75	652	80,00
	5	5050	70-125	9	267	126	5	652	101,00
	6	5050	70-125	9	267	126	17,75	652	115,00
	8	5050	70-125	9	267	126	43,25	652	138,50
800	3	4040	55-100	3	215	101	8	742	82,00
	4	5050	70-125	3	267	126	7,75	742	120,00
	5	5050	70-125	9	267	126	5	742	132,00
	6	5050	70-125	9	267	126	17,75	742	136,00
	8	5050	70-125	9	267	126	43,25	742	154,00
1000	3	4040	55-100	3	215	101	8	942	110,00
	4	5050	70-125	3	267	126	7,75	942	139,00
	5	5050	70-125	9	267	126	5	942	133,00
	6	5050	70-125	9	267	126	17,75	942	158,00
	8	5050	70-125	9	267	126	43,25	942	206,00
1250	3	5050	70-125	3	267	126	20,5	1190	138,00
	4	5050	70-125	3	267	126	7,75	1190	184,00
	5	5050	70-125	9	267	126	5	1190	192,00
	6	5050	70-125	9	267	126	17,75	1190	212,00
	8	5050	70-125	9	267	126	43,25	1190	274,00

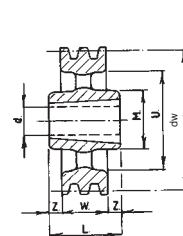

fig. 3

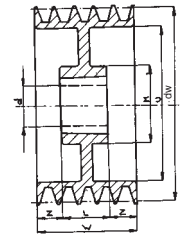

fig. 6

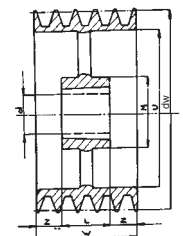

fig. 9

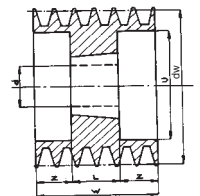

fig. 11

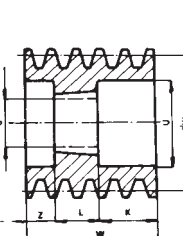

fig. 13

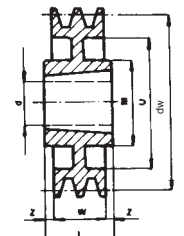

fig. 14

* K = 78

SER-SIT® BUSSOLE CONICHE

La bussole coniche SER-SIT® permette un montaggio tecnicamente perfetto e lo smontaggio delle pulegge (e anche di numerosi organi di trasmissione) in un tempo molto breve e senza l'uso di attrezzi particolari oltre ad una chiave esagonale. L'ampia gamma di fori finiti disponibili assicura un immediato montaggio senza attendere le lavorazioni di officina interne od esterne ed il costo relativo. Le bussole sono finite all'interno di cava per chiavetta secondo le norme DIN e UNI, anche se in moltissimi casi basta la pressione esercitata dal serraggio dei grani per trasmettere la coppia richiesta. Il fissaggio mediante bussole coniche SER-SIT® permette di eliminare ogni gioco tra albero e foro, in modo tale da evitare definitivamente la formazione di ruggine di contatto (fretting corrosion). La bussola conica SER-SIT® è intercambiabile con i tipi di bussola analoghi diffusi in tutto il mondo.

SER-SIT® TAPER LOCK BUSHING

SER-SIT® taper lock bush is designed to give the following:

- 1) perfect assembly;
- 2) rapid dismantling of the pulley and other transmission equipment;
- 3) no special tools requirement except hexagonal key.

The large range of finished bores available ensures that an immediate assembly can be made thus avoiding costly factory down-time. The bushes are machined with keyways in accordance with UNI and DIN specifications. This is in addition to clamping screws which, in many cases, are sufficient to meet the required torque. Fastening by SER-SIT® bushes allows the removal of any clearance between hub and bore so that fretting corrosion is positively eliminated. SER-SIT® bushes are interchangeable with all similar types sold throughout the world.

MOYEU AMOVIBLE SER-SIT®

Les moyeux amovibles SER-SIT® permettent un montage techniquement parfait et un démontage rapide des poulies (ainsi que de nombreux organes de transmission) à l'aide uniquement d'une clé hexagonale. La gamme étendue des alésages finis disponibles permet un montage immédiat et économique. Les moyeux amovibles sont prévus avec rainures de clavettes aux normes DIN et UNI; pour de faibles puissances le serrage du moyeu sur l'arbre est suffisant pour transmettre le couple. Le montage à l'aide des moyeux amovibles SER-SIT® permet d'éliminer le jeu entre l'arbre et l'alésage, ce qui évite la formation de rouille de contact (fretting corrosion). Les moyeux amovibles SER-SIT® sont interchangeables avec tous les types de moyeux amovibles analogues répandus dans le monde entier.

SER-SIT® SPANN- BUCHSEN

SER-SIT® Spannbuchsen sind für folgende Eigenschaften entwickelt:

- 1) Perfekte Montage;
- 2) Schnelles Entfernen der Scheiben und anderer Antriebs-elemente;
- 3) Erfordern kein Spezialwerkzeug, außer einem Imbus-Schlüssel.

Die breite Herstellungspalette der verfügbaren Bohrungen stellt sicher, daß eine sofortige Montage erfolgen kann, hierdurch werden kostspielige Maschinenstandzeiten vermieden. Die Buchsen sind gemäß UNI und DIN Normen mit Paßfedernuten gefertigt, zusätzlich zu den Klemmschrauben, die in vielen Fällen ausreichend sind, um die geforderte Spannung zu erreichen. SER-SIT® Spannbuchsen können in beliebiger Position auf der Welle montiert werden, so daß Passungsrost weitgehend ausgeschlossen wird. SER-SIT®-Buchsen sind austauschbar mit allen ähnlichen marktgängigen Typen.

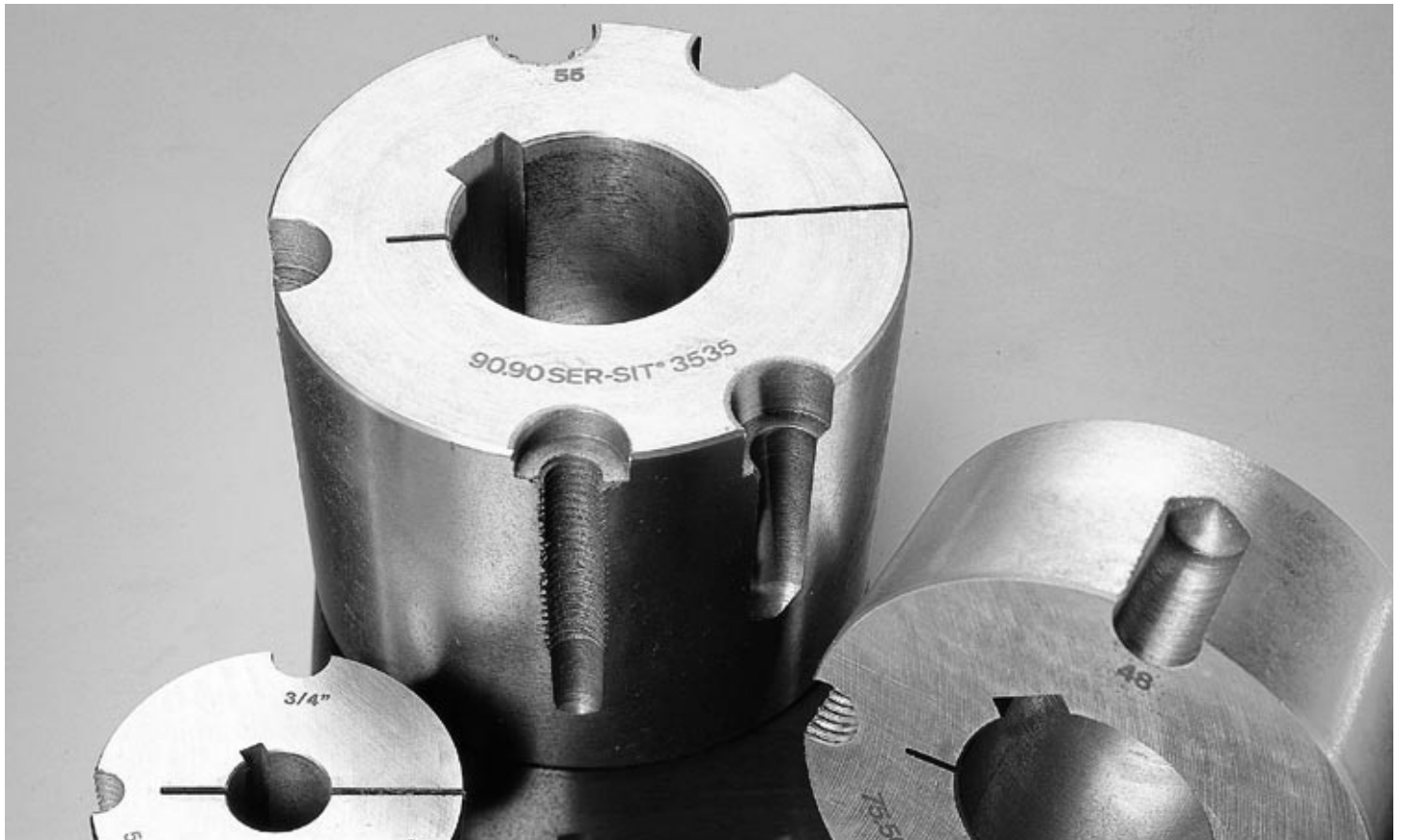

tipo type type Typ	Diametro del foro Diameter of the bore Diametre des alésage Bohrungsdurchmesser		Bussola - Bush - Moyeu - Buchse		Viti - Screws - Vis - Schrauben				
			Lunghezza length longeur Länge	Diametro massimo max. diameter max. diametre max. Durchmesser	n°	withworth	lunghezza length longeur Länge	Chiave tipo esagonale set screw wrench type clef hexagonale type Imbus- Schlüssel Typ	Ms
1008 (25.20)	mm inches	11 12 14 15 16 18 19 20 22 24 25 3/4 3/8 1/2 5/8 3/4 7/8 1	22,3	35	2	1/4	13	3	5,5
1108 (28.20)	mm inches	11 12 14 15 16 17 18 19 20 22 24 25 26 27 28 3/8 1/2 5/8 3/4 7/8 1 1 1/8	22,3	38	2	1/4	13	3	5,5
1210 (30.25)	mm inches	11 12 14 15 16 18 19 20 22 24 25 26 28 30 32 1/2 5/8 3/4 7/8 1 1 1/8 1 1/4 1 1/2	25,4	47	2	3/8	16	5	20
1215 (30.40)	mm inches	12 14 15 16 18 19 20 22 24 25 26 28 30 32 1/2 5/8 3/4 7/8 1 1 1/8 1 1/4	38,1	47	2	3/8	16	5	20
1310 (35.25)	mm inches	14 16 18 19 20 22 24 25 28 30 32 35 1/2 5/8 3/4 7/8 1 1 1/8 1 1/4 1 1/2	25,4	52	2	3/8	16	5	20
1610 (40.25)	mm inches	12 14 15 16 18 19 20 22 24 25 26 28 30 32 35 38 40 42 3/8 1/2 5/8 3/4 7/8 1 1 1/8 1 1/4 1 1/2 1 3/4	25,4	57	2	3/8	16	5	20
1615 (40.40)	mm inches	12 14 15 16 18 19 20 22 24 25 26 28 30 32 35 38 40 42 1/2 5/8 3/4 7/8 1 1 1/8 1 1/4 1 1/2 1 3/4	38,1	57	2	3/8	16	5	20
2012 (50.30)	mm inches	14 15 16 18 19 20 22 24 25 26 28 30 32 35 38 40 42 45 48 50 5/8 3/4 7/8 1 1 1/8 1 1/4 1 1/2 1 3/4 1 1/2 2	31,8	70	2	7/16	22	5	20
2517 (65.45)	mm inches	18 19 20 22 24 25 28 30 32 35 38 40 42 45 48 50 55 60 65 3/4 7/8 1 1 1/8 1 1/4 1 1/2 1 3/4 1 1/2 2 2 1/8 2 1/4 2 1/2 2 3/8	44,5	85	2	1/2	25	6	50
3020 (75.50)	mm inches	22 25 28 30 32 35 38 40 42 45 48 50 55 57 60 65 70 75 1 1 1/8 1 1/2 1 3/4 1 1/2 2 2 1/8 2 1/4 2 1/2 2 3/8 2 1/2 2 3/4 2 1/2 3	50,8	108	2	5/8	32	8	90
3030 (75.75)	mm inches	42 45 47 48 50 55 60 65 70 75 1 1/4 1 3/8 1 1/2 1 3/4 1 1/2 2 2 1/8 2 1/4 2 1/2 2 3/8 2 1/2 2 3/4 2 1/2 3	76,2	108	2	5/8	32	8	90
3535 (90.90)	mm inches	25 35 38 40 42 45 48 50 55 60 65 70 75 80 85 90 1 1/2 1 3/8 1 1/2 1 3/4 2 2 1/8 2 1/4 2 1/2 2 3/8 2 1/2 3 3 1/8 3 1/4 3 3/8 3 1/2	88,9	127	3	1/2	38	10	115
4040 (100.100)	mm inches	45 50 55 60 65 70 75 80 85 90 95 100 1 3/4 2 2 3/8 3 3/4 4	101,6	146	3	5/8	44	14	170
4545 (115.115)	mm inches	55 60 65 70 75 80 85 90 95 100 105 110 3 3 1/2 4	114,3	162	3	3/4	51	14	195
5050 (125.125)	mm inches	50 60 65 70 75 80 85 90 95 100 110 115 120 125 3 1/2 4	127	178	3	7/8	57	17	275

Il primo gruppo di numeri indicano il foro massimo, il secondo la lunghezza in mm.

The first group of numbers indicates maximum bore, the second conventional length in mm.

Le premier groupe de chiffres indique l'alésage maxi, le deuxième la longueur conventionnelle en mm.

In der ersten Spalte wird die max. Bohrung, in der zweiten Spalte die übliche Länge angegeben.

I diametri dei fori in grassetto indicano bussole cotruite in acciaio

Bore diameters in bold type are made in steel instead of cast iron.

Les diametres des alésages imprimés en gras sont construits en acier, les autres types normalement fournis en fonte

Die fettgedruckten Bohrungsdurchmessern bezeichnen die Stahlbuschen.

Ms = coppia di serraggio viti

Ms = screw tightening torque

Ms = couple de serrage des vis

Ms = Festzieh-Drehmoment der Schrauben

Chiavetta, Keyway, Rainures, Paßfedernutsize : UNI 6604-69 / DIN 6885		
Diametro foro bore diameter alésage Bohrung [mm]	b [mm]	t ₂ [mm]
10÷12	4	1,8
13÷17	5	2,3
18÷22	6	2,8
23÷30	8	3,3
31÷38	10	3,3
39÷44	12	3,3
45÷50	14	3,8
51÷58	16	4,3
59÷65	18	4,4
66÷75	20	4,9
76÷85	22	5,4
86÷95	25	5,4
96÷110	28	6,4
111÷130	32	7,4

Sedi chiavetta ribassata solo per i fori massimi ed esclusivamente nelle bussole riportate in tabella Reduced keyway only when the undermentioned bores are the maximum bores and only in the bushing types shown in table. Rainures réduites pour les alésages maxi. uniquement pour moyeux ci-dessous. Reduzierte Paßfedernuttenhöhe nur anwendbar bei max. Bohrungsdurchmesser und bei den unten genannten Buchsentypen.			
Diametro foro bore diameter alésage Bohrung [mm]	Tipi di bussola conica bushing type moyeu type Buchsentype	b [mm]	t ₂ [mm]
28	1108	8	2,3
32	1210 - 1215	10	2,3
40/42	1610 - 1615	12	2,3

Sedi chiave su bussole SER-SIT® (B.S. 46) Keyway on SER-SIT® taper bush (B.S. 46) Rainures des moyeux amovibles SER-SIT® (B.S. 46) Paßfedernut für Taper-spannbuchsen SER-SIT® (B.S. 46)		
bore diameter - alésage Bohrung - agujero [inches]	b [inches]	t ₂ [inches]
3/8÷1/2	1/8	1/16
9/16÷3/4	3/16	3/32
13/16÷1	1/4	1/8
1/16÷1-1/4	5/16	1/8
1-5/16÷1-1/2	3/8	1/8
1-5/8÷1-3/4	7/16	5/32
1-7/8÷2	1/2	5/32
2-1/8÷2-1/2	5/8	7/32
2-5/8÷3	3/4	1/4
3-1/8÷3-1/2	7/8	5/16
3-3/4÷4	1	3/8
4-1/4÷5	1-1/4	7/16

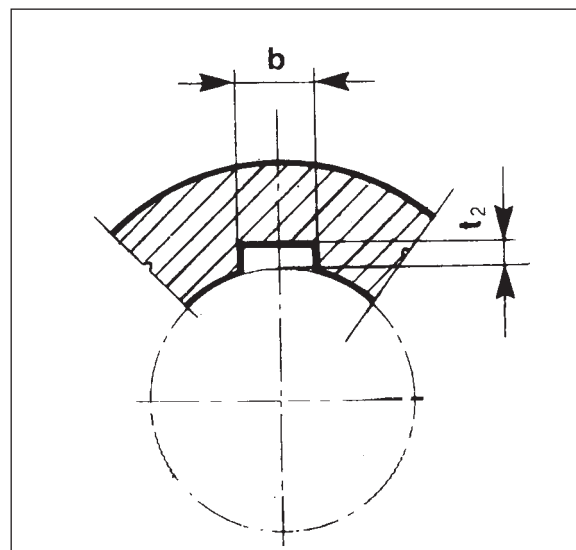

Montaggio e smontaggio delle bussole coniche SER-SIT®

- Prima di collocare la bussola nella puleggia pulire accuratamente le parti coniche ed il foro.
- Inserire la bussola nella puleggia, avendo cura di far coincidere i semifori filettati della puleggia con i semifori non filettati della bussola.
- Avvitare a mano i grani senza serrarli.
- Inserire il tutto sull'albero, dopo averlo pulito accuratamente, posizionare e serrare le viti alternativamente.
- Per smontare: svitare le viti e inserirne una nel foro libero, avvitando a fondo sino allo sblocco del mozzo.

NOTA - Porre la massima attenzione affinché il dorso della chiave non venga a contatto con il fondo della cava ma rimanga invece sempre un certo gioco.

Assembly and dismantling of SER-SIT® conical bushing

- Before fitting the bushing, carefully clean the bore and conical parts.
- Fit the bushing into the pulley, taking care to let the threaded half-holes of the pulley coincide with the unthreaded holes of the bushing.
- Hand tighten the screws.
- Fit the pulley to the hub after carefully cleaning it. Position it and tighten the screws alternately.
- Dismantling: remove screws and replace one screw in the jacking hole provided and tighten until hub is released.

NOTE - Ensure that the key does not bottom in the keyway. Clearance in recommended in the keyway bottom.

Montage et démontage des moyeux amovibles SER-SIT®

- Avant de placer le moyeu amovible dans la poulie, nettoyer soigneusement son logement et l'alésage.
- Placer le moyeu amovible dans la poulie, en faisant attention de faire coïncider les demi-alésages filetés de la poulie, avec les demi-alésages non filetés du moyeu amovible.
- Engager les vis a la main sans les serrer.
- Présenter le tout sur l'arbre, après l'avoir nettoyé soigneusement, mettre en position et serrer les vis alternativement.
- Pour démonter: Retirer les vis et engager l'une d'elles dans l'alésage libre en visant à fond jusqu'à déblocage du moyeu.

N.B. - Le sommet de la clavette ne doit pas être en contact avec le fond de son logement dans le moyeu - vérifier qu'il subsiste un jeu.

Montage und Demontage der SER-SIT® Spannbuchsen

- Von der Montage der Buchse sind die Bohrungen und die konischen Teile sorgfältig zu reinigen.
- Die Buchse in die Scheibe einsetzen und die geschnittenen Halbbohrungen der Scheibe mit den ungeschnittenen Halbbohrungen der Buchse zusammenfallen lassen.
- Die Schrauben mit der Hand anziehen.
- Nach sorgfältiger Reinigung setzen Sie die Nabe der Scheibe auf die Welle. Richten Sie die Scheibe aus und befestigen Sie die Schrauben gleichmäßig.
- Demontieren Sie die Schrauben, setzen Sie eine Schraube in das vorhandene Gewinde der Abziehvorrichtung ein, und drehen Sie die Schraube bis die Scheibe sich löst.

ANMERKUNG: Stellen Sie sicher, daß die Schraube nicht bis zum Ende des Sachgewindeloches vordringt.

Pulegge PCT

PCT pulleys

Poulies PCT

PCT
Keilriemenscheiben

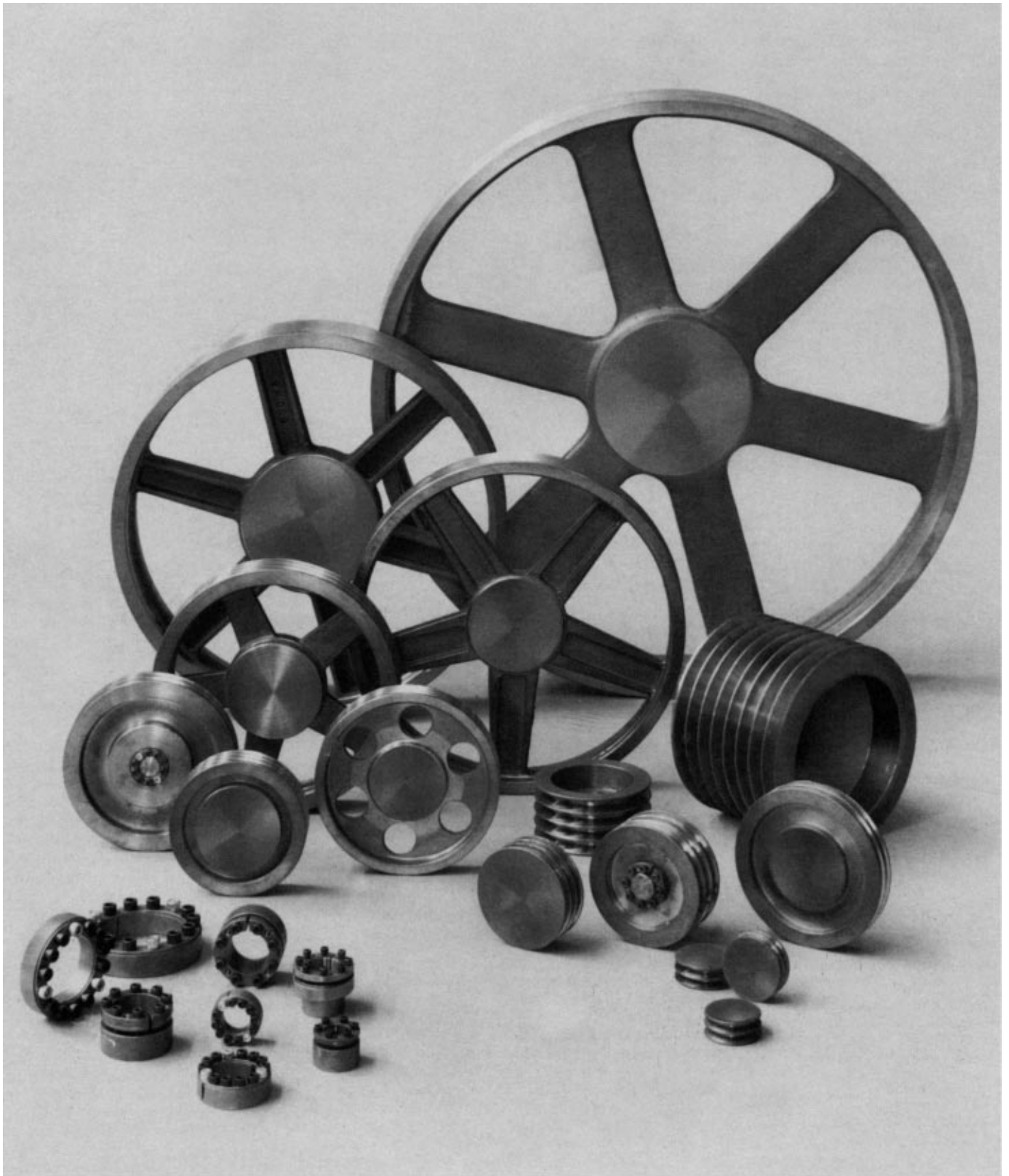

Dimensioni delle pulegge PCT con mozzo sovradimensionato per calettatori

Dimensions of PCT pulleys with oversized hub for self-locking units

Dimensions des poulies PCT avec moyeux surdimensionnés pour moyeux de serrage

Abmessungen der PCT-Scheiben mit überdimensionierter Nabe zur Montage mit Spannsätzen

• Le pulegge PCT sono dimensionate per montaggio con calettatori SIT-LOCK® 8.

• PCT pulleys are designed for assembly with self-locking units SIT-LOCK® 8.

• Les poulies PCT sont prévues pour moyeux de serrage SIT-LOCK® 8.

• Die Keilriemenscheiben PCT sind zur Montage mit dem Spannsätze SIT-LOCK® 8.

“PCT” SPZ-Z-3V

Diametro primitivo pitch diameter diamètre primitif Wirkdurchmesser dw [mm]	gole grooves gorges Rillen N°	forma size forme Ausführung fig.	M [mm]	L [mm]	Z [mm]	U [mm]	d H8 [mm]
90	1	1	80	23	7	—	55
	2	3	—	28	—	—	55
	3	3	—	40	—	—	55
	4	3	—	52	—	—	55
	5	3	—	64	—	—	55
95	1	3	—	23	—	—	55-65
	2	3	—	28	—	—	55-65
	3	3	—	40	—	—	55-65
	4	3	—	52	—	—	55-65
	5	3	—	64	—	—	55-65
100	1	3	—	23	—	—	55-65
	2	2	—	26	2	73	55-65
	3	2	—	26	14	73	55-65
	4	2	—	26	26	73	55-65
	5	2	—	26	38	73	55-65
106	1	3	—	23	—	—	55-65
	2	2	—	26	2	78	55-65
	3	2	—	26	14	78	55-65
	4	2	—	26	26	78	55-65
	5	2	—	26	38	78	55-65
112	1	3	—	23	—	—	55-65
	2	2	—	26	2	85	55-65
	3	2	—	26	14	85	55-65
	4	2	—	26	26	85	55-65
	5	2	—	26	38	85	55-65
118	1	3	—	26	—	—	55-65-80
	2	2	—	26	2	93	55-65-80
	3	2	—	26	14	93	55-65-80
	4	2	—	26	26	93	55-65-80
	5	2	—	26	38	93	55-65-80
125	1	3	—	26	—	—	55-65-80
	2	2	—	26	2	98	55-65-80
	3	2	—	26	14	98	55-65-80
	4	2	—	26	26	98	55-65-80
	5	2	—	26	38	98	55-65-80
132	1	3	—	26	—	—	55-65-80
	2	2	—	26	2	105	55-65-80
	3	2	—	26	14	105	55-65-80
	4	2	—	26	26	105	55-65-80
	5	2	—	26	38	105	55-65-80
140	1	3	—	26	—	—	55-65-80
	2	2	—	26	2	113	55-65-80
	3	2	—	26	14	113	55-65-80
	4	2	—	26	26	113	55-65-80
	5	2	—	26	38	113	55-65-80
150	1	5	100	26	5	123	55-65-80
	2	6	105	26	1	123	55-65-80
	3	6	105	26	7	123	55-65-80
	4	4	—	26	13	123	55-65-80
	5	4	—	26	19	123	55-65-80
160	1	5	100	26	5	133	55-65-80
	2	6	105	26	1	133	55-65-80
	3	6	105	26	7	133	55-65-80
	4	6	120	26	13	133	55-65-80
	5	6	120	26	19	133	55-65-80
180	1	5	100	26	5	153	55-65-80
	2	6	105	26	1	153	55-65-80
	3	6	105	26	7	153	55-65-80
	4	6	120	26	13	153	55-65-80
	5	6	120	26	19	153	55-65-80

“PCT” SPZ-Z-3V

W: see Tab. 1

Diametro primitivo pitch diameter diamètre primitif Wirkdurchmesser dw [mm]	gole grooves gorges Rillen N°	forma size forme Ausführung fig.	M [mm]	L [mm]	Z [mm]	U [mm]	d H8 [mm]
200	1	5	100	26	5	173	55-65-80
	2	6	105	26	1	173	55-65-80
	3	6	105	26	7	173	55-65-80
	4	6	120	26	13	173	55-65-80
	5	6	120	26	19	173	55-65-80
224	1	5	100	26	5	197	55-65-80
	2	6	105	26	1	197	55-65-80
	3	6	105	26	7	197	55-65-80
	4	6	120	26	13	197	55-65-80
	5	6	120	26	19	197	55-65-80
250	1	7	115	26	5	223	55-65-80
	2	8	120	26	1	223	55-65-80
	3	8	120	26	7	223	55-65-80
	4	8	120	26	13	223	55-65-80
	5	8	120	26	19	223	55-65-80
280	1	7	115	26	5	253	55-65-80
	2	8	120	26	1	253	55-65-80
	3	8	120	26	7	253	55-65-80
	4	8	120	26	13	253	55-65-80
	5	8	120	26	19	253	55-65-80
315	1	7	115	26	5	288	55-65-80
	2	8	120	26	1	288	55-65-80
	3	8	120	26	7	288	55-65-80
	4	8	120	26	13	288	55-65-80
	5	8	120	26	19	288	55-65-80
355	1	7	115	26	5	328	55-65-80
	2	8	120	26	1	328	55-65-80
	3	8	120	26	7	328	55-65-80
	4	8	120	26	13	328	55-65-80
	5	8	120	26	19	328	55-65-80
400	1	7	115	26	5	373	55-65-80
	2	8	120	26	1	373	55-65-80
	3	8	120	26	7	373	55-65-80
	4	8	120	26	13	373	55-65-80
	5	8	120	26	19	373	55-65-80

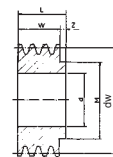

fig. 1

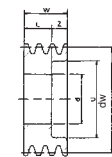

fig. 2

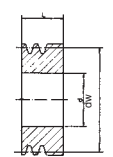

fig. 3

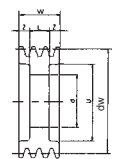

fig. 4

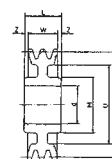

fig. 5

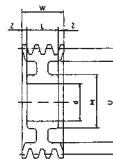

fig. 6

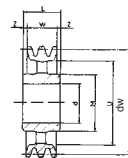

fig. 7

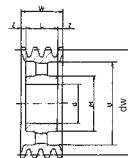

fig. 8



“PCT” SPA-A

Diametro primitivo pitch diameter diamètre primitif Wirkdurchmesser dw [mm]	gole grooves gorges Rillen N°	forme size forme Ausführung fig.	M [mm]	L [mm]	Z [mm]	U [mm]	d H8 [mm]
90•	1	1	80	23	3	–	55
	2	3	–	35	–	–	55
	3	3	–	50	–	–	55
	4	3	–	65	–	–	55
	5	3	–	80	–	–	55
95•	1	1	80	23	3	–	55
	2	2	–	26	9	63	55
	3	2	–	26	24	63	55
	4	4	–	26	19,5	63	55
	5	4	–	26	27	63	55
100	1	1	90	23	3	–	55-65
	2	2	–	26	9	68	55-65
	3	2	–	26	24	68	55-65
	4	2	–	26	39	68	55-65
	5	2	–	26	54	68	55-65
106	1	1	90	23	3	–	55-65
	2	2	–	26	9	73	55-65
	3	2	–	26	24	73	55-65
	4	2	–	26	39	73	55-65
	5	2	–	26	54	73	55-65
112	1	1	90	23	3	–	55-65
	2	2	–	26	9	79	55-65
	3	2	–	26	24	79	55-65
	4	2	–	26	39	79	55-65
	5	2	–	26	54	79	55-65
118	1	1	90	23	3	–	55-65
	2	2	–	26	9	85	55-65-80
	3	2	–	26	24	85	55-65-80
	4	2	–	26	39	85	55-65-80
	5	2	–	26	54	85	55-65-80
125	1	1	90	23	3	–	55-65
	2	2	–	26	9	92	55-65-80
	3	2	–	26	24	92	55-65-80
	4	2	–	26	39	92	55-65-80
	5	4	–	26	27	92	55-65-80
132	1	1	90	23	3	–	55-65
	2	2	–	26	9	99	55-65-80
	3	2	–	26	24	99	55-65-80
	4	2	–	26	39	99	55-65-80
	5	4	–	26	27	99	55-65-80
140	1	1	90	23	3	–	55-65
	2	2	–	26	9	107	55-65-80
	3	2	–	26	24	107	55-65-80
	4	2	–	26	39	107	55-65-80
	5	4	–	26	27	107	55-65-80
150	1	5	95	23	1,5	117	55-65
	2	6	105	26	4,5	117	55-65-80
	3	6	120	26	12	117	55-65-80
	4	6	120	26	19,5	117	55-65-80
	5	6	120	26	27	117	55-65-80
160	1	5	95	26	3	127	55-65-80
	2	6	105	26	4,5	127	55-65-80
	3	6	120	26	12	127	55-65-80
	4	6	120	26	19,5	127	55-65-80
	5	6	120	26	27	127	55-65-80
170	1	5	95	26	3	137	55-65-80
	2	6	105	26	4,5	137	55-65-80
	3	6	120	26	12	137	55-65-80
	4	6	120	26	19,5	137	55-65-80
	5	6	120	26	27	137	55-65-80
180	1	5	100	26	3	147	55-65-80
	2	6	105	26	4,5	147	55-65-80
	3	6	120	26	12	147	55-65-80
	4	6	120	26	19,5	147	55-65-80
	5	6	120	26	27	147	55-65-80

• Da usare solo con cinghie «A» oppure con cinghie «SPA dentellate internamente».

• To be used only with V-belts «A» or internally notched SPA sections.

“PCT” SPA-A

W: see Tab. 1

Diametro primitivo pitch diameter diamètre primitif Wirkdurchmesser dw [mm]	gole grooves gorges Rillen N°	forma size forme Ausführung fig.	M [mm]	L [mm]	Z [mm]	U [mm]	d H8 [mm]
190	1	5	100	26	3	157	55-65-80
	2	6	105	26	4,5	157	55-65-80
	3	6	120	26	12	157	55-65-80
	4	6	120	26	19,5	157	55-65-80
	5	6	120	26	27	157	55-65-80
200	1	5	100	26	3	167	55-65-80
	2	6	105	26	4,5	167	55-65-80
	3	6	120	26	12	167	55-65-80
	4	6	120	26	19,5	167	55-65-80
	5	6	120	26	27	167	55-65-80
224	1	5	100	26	3	191	55-65-80
	2	6	105	26	4,5	191	55-65-80
	3	6	120	26	12	191	55-65-80
	4	6	120	26	19,5	191	55-65-80
	5	6	120	26	27	191	55-65-80
236	1	7	100	26	3	203	55-65-80
	2	6	120	26	4,5	203	55-65-80
	3	6	120	26	12	203	55-65-80
	4	6	120	26	19,5	203	55-65-80
	5	6	120	26	27	203	55-65-80
250	1	7	115	26	3	217	55-65-80
	2	8	120	26	4,5	217	55-65-80
	3	8	120	26	12	217	55-65-80
	4	8	120	26	19,5	217	55-65-80
	5	8	130	26	27	217	55-65-80
280	1	7	115	26	3	247	55-65-80
	2	8	120	26	4,5	247	55-65-80
	3	8	120	26	12	247	55-65-80
	4	8	120	26	19,5	247	55-65-80
	5	8	130	26	27	247	55-65-80
315	1	7	115	26	3	282	55-65-80
	2	8	120	26	4,5	282	55-65-80
	3	8	120	26	12	282	55-65-80
	4	8	120	26	19,5	282	55-65-80
	5	8	130	26	27	282	55-65-80
355	1	7	115	26	3	322	55-65-80
	2	8	120	26	4,5	322	55-65-80
	3	8	120	26	12	322	55-65-80
	4	8	120	26	19,5	322	55-65-80
	5	8	130	26	27	322	55-65-80
400	1	7	115	26	3	367	55-65-80
	2	8	120	26	4,5	367	55-65-80
	3	8	120	26	12	367	55-65-80
	4	8	120	26	19,5	367	55-65-80
	5	8	130	26	27	367	55-65-80
450	1	7	115	26	3	417	55-65-80
	2	8	120	26	4,5	417	55-65-80
	3	8	120	26	12	417	55-65-80
	4	8	120	26	19,5	417	55-65-80
	5	8	130	26	27	417	55-65-80
500	1	7	115	26	3	467	55-65-80
	2	8	120	26	4,5	467	55-65-80
	3	8	120	26	12	467	55-65-80
	4	8	120	26	19,5	467	55-65-80
	5	8	130	26	27	467	55-65-80
560	1	7	115	26	3	527	55-65-80
	2	8	120	26	4,5	527	55-65-80
	3	8	120	26	12	527	55-65-80
	4	8	120	26	19,5	527	55-65-80
	5	8	130	26	27	527	55-65-80
630	1	7	115	26	3	597	55-65-80
	2	8	120	26	4,5	597	55-65-80
	3	8	120	26	12	597	55-65-80
	4	8	120	26	19,5	597	55-65-80
	5	8	130	26	27	597	55-65-80

• À utiliser avec courroies section «A» ou «SPA crantées».

• Einsatz nur mit Treibriemen Profil «A» oder Profil «SPA mit Innen-Verzahnung».

“PCT” SPB-B-5V

Diametro primitivo pitch diameter diamètre primitif Wirkdurchmesser dw [mm]	gole grooves gorges Rillen N°	forma size forme Ausführung fig.	M [mm]	L [mm]	Z [mm]	U [mm]	d H8 [mm]
106•	1	2	–	23	2	66	55
	2	2	–	26	18	66	55
	3	2	–	26	37	66	55
	4	4	–	26	28	66	55
	5	4	–	26	37,5	66	55
112•	1	2	–	23	2	72	55-65
	2	2	–	26	18	72	55-65
	3	2	–	26	37	72	55-65
	4	4	–	26	28	72	55-65
	5	4	–	26	37,5	72	55-65
118•	1	2	–	23	2	78	55-65
	2	2	–	26	18	78	55-65
	3	2	–	26	37	78	55-65
	4	4	–	26	28	78	55-65
	5	4	–	26	37,5	78	55-65
125•	1	2	–	23	2	85	55-65
	2	2	–	26	18	85	55-65
	3	2	–	26	37	85	55-65
	4	4	–	26	28	85	55-65
	5	4	–	26	37,5	85	55-65
	6	4	–	26	47	85	55-65
132•	1	2	–	23	2	92	55-65
	2	2	–	26	18	92	55-65-80
	3	2	–	26	37	92	55-65-80
	4	4	–	26	28	92	55-65-80
	5	4	–	26	37,5	92	55-65-80
	6	4	–	26	47	92	55-65-80
140•	1	2	–	23	2	100	55-65
	2	2	–	26	18	100	55-65-80
	3	2	–	26	37	100	55-65-80
	4	4	–	26	28	100	55-65-80
	5	4	–	26	37,5	100	55-65-80
	6	4	–	26	47	100	55-65-80
150•	1	2	–	23	2	110	55-65
	2	2	–	26	18	110	55-65-80
	3	2	–	26	37	110	55-65-80
	4	4	–	26	28	110	55-65-80
	5	4	–	26	37,5	110	55-65-80
	6	4	–	26	47	110	55-65-80
160	1	6	100	26	0,5	120	55-65-80
	2	2	–	26	18	120	55-65-80
	3	2	–	26	37	120	55-65-80
	4	4	–	26	28	120	55-65-80
	5	4	–	26	37,5	120	55-65-80
	6	4	–	26	47	120	55-65-80
	8	4	–	26	66	120	55-65-80
	170	1	6	100	26	0,5	130
2		6	110	26	9	130	55-65-80
3		6	110	26	18,5	130	55-65-80
4		6	120	26	28	130	55-65-80
5		6	120	26	37,5	130	55-65-80
6		6	120	26	47	130	55-65-80
8		6	120	26	66	130	55-65-80
180		1	6	100	26	0,5	140
	2	6	110	26	9	140	55-65-80
	3	6	120	26	18,5	140	55-65-80
	4	6	120	26	28	140	55-65-80
	5	6	120	26	37,5	140	55-65-80
	6	6	120	26	47	140	55-65-80
	8	6	120	26	66	140	55-65-80
	190	1	6	100	26	0,5	150
2		6	120	26	9	150	55-65-80
3		6	120	26	18,5	150	55-65-80
4		6	120	26	28	150	55-65-80
5		6	120	26	37,5	150	55-65-80
6		6	120	26	47	150	55-65-80
8		6	120	26	66	150	55-65-80

“PCT” SPB-B-5V

W: see Tab. 1

Diametro primitivo pitch diameter diamètre primitif Wirkdurchmesser dw [mm]	gole grooves gorges Rillen N°	forma size forme Ausführung fig.	M [mm]	L [mm]	Z [mm]	U [mm]	d H8 [mm]
200	1	6	100	26	0,5	160	55-65-80
	2	6	120	26	9	160	55-65-80
	3	6	120	26	18,5	160	55-65-80
	4	6	120	26	28	160	55-65-80
	5	6	120	26	37,5	160	55-65-80
	6	6	120	26	47	160	55-65-80
	8	6	120	26	66	160	55-65-80
	212	1	6	100	26	0,5	172
2		6	120	26	9	172	55-65-80
3		6	120	26	18,5	172	55-65-80
4		6	120	26	28	172	55-65-80
5		6	120	26	37,5	172	55-65-80
6		6	120	26	47	172	55-65-80
8		6	120	26	66	172	55-65-80
224		1	6	100	26	0,5	184
	2	6	120	26	9	184	55-65-80
	3	6	120	26	18,5	184	55-65-80
	4	6	120	26	28	184	55-65-80
	5	6	120	26	37,5	184	55-65-80
	6	6	120	26	47	184	55-65-80
	8	6	120	26	66	184	55-65-80

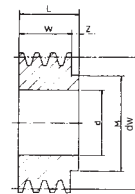

fig. 1

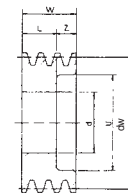

fig. 2

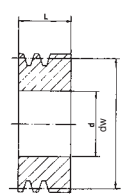

fig. 3

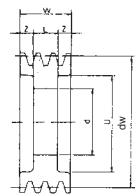

fig. 4

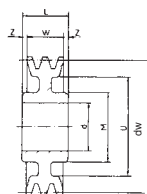

fig. 5

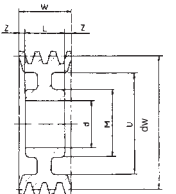

fig. 6

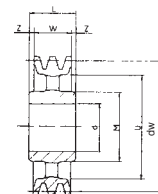

fig. 7

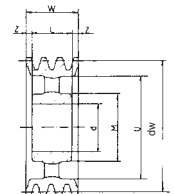

fig. 8

• Da usare con cinghie «B» oppure con cinghie «SPB dentellate internamente».

• To be used only with V-belts «B» or internally notched SPB sections.

• À utiliser avec courroies section «B» ou «SPB crantées».

• Einsatz nur mit Treibriemen Profil «B» oder Profil «SPB mit Innen-Verzahnung».



“PCT” SPB-B-5V

Diametro primitivo pitch diameter diamètre primitif Wirkdurchmesser dw [mm]	gole grooves gorges Rillen N°	forma size forme Ausführung fig.	M	L	Z	U	d H8
			[mm]	[mm]	[mm]	[mm]	[mm]
236	1	6	115	26	0,5	196	55-65-80
	2	6	120	26	9	196	55-65-80
	3	6	120	26	18,5	196	55-65-80
	4	6	120	26	28	196	55-65-80
	5	6	130	26	37,5	196	55-65-80
	6	6	130	26	47	196	55-65-80
	8	6	130	26	66	196	55-65-80
	250	1	8	115	26	0,5	210
2		8	120	26	9	210	55-65-80
3		8	120	26	18,5	210	55-65-80
4		8	120	26	28	210	55-65-80
5		6	130	26	37,5	210	55-65-80
6		6	130	26	47	210	55-65-80
8		6	130	26	66	210	55-65-80
280		1	7	115	26	0,5	240
	2	8	120	26	9	240	55-65-80
	3	8	120	26	18,5	240	55-65-80
	4	8	120	26	28	240	55-65-80
	5	8	130	26	37,5	240	55-65-80
	6	8	130	26	47	240	55-65-80
	8	8	130	26	66	240	55-65-80
	300	1	7	115	26	0,5	260
2		8	120	26	9	260	55-65-80
3		8	120	26	18,5	260	55-65-80
4		8	120	26	28	260	55-65-80
5		8	130	26	37,5	260	55-65-80
6		8	130	26	47	260	55-65-80
8		8	130	26	66	260	55-65-80
315		1	7	115	26	0,5	275
	2	8	120	26	9	275	55-65-80
	3	8	120	26	18,5	275	55-65-80
	4	8	120	26	28	275	55-65-80
	5	8	130	26	37,5	275	55-65-80
	6	8	130	26	47	275	55-65-80
	8	8	130	26	66	275	55-65-80
	355	1	7	115	26	0,5	315
2		8	120	26	9	315	55-65-80
3		8	120	26	18,5	315	55-65-80
4		8	120	26	28	315	55-65-80
5		8	130	26	37,5	315	55-65-80
6		8	130	26	47	315	55-65-80
8		8	130	26	66	315	55-65-80
400		1	7	115	26	0,5	360
	2	8	120	26	9	360	55-65-80
	3	8	120	26	18,5	360	55-65-80
	4	8	120	26	28	360	55-65-80
	5	8	130	26	37,5	360	55-65-80
	6	8	130	26	47	360	55-65-80
	8	8	130	26	66	360	55-65-80
	450	1	7	115	26	0,5	410
2		8	120	26	9	410	55-65-80
3		8	120	26	18,5	410	55-65-80
4		8	120	26	28	410	55-65-80
5		8	130	26	37,5	410	55-65-80
6		8	130	26	47	410	55-65-80
8		8	130	26	66	410	55-65-80
500		1	7	115	26	0,5	460
	2	8	120	26	9	460	55-65-80
	3	8	120	26	18,5	460	55-65-80
	4	8	120	26	28	460	55-65-80
	5	8	130	26	37,5	460	55-65-80
	6	8	130	26	47	460	55-65-80
	8	8	130	26	66	460	55-65-80

“PCT” SPB-B-5V

W: see Tab. 1

Diametro primitivo pitch diameter diamètre primitif Wirkdurchmesser dw [mm]	gole grooves gorges Rillen N°	forma size forme Ausführung fig.	M	L	Z	U	d H8
			[mm]	[mm]	[mm]	[mm]	[mm]
560	1	7	115	26	0,5	520	55-65-80
	2	8	120	26	9	520	55-65-80
	3	8	120	26	18,5	520	55-65-80
	4	8	120	26	28	520	55-65-80
	5	8	130	26	37,5	520	55-65-80
	6	8	130	26	47	520	55-65-80
	8	8	130	26	66	520	55-65-80
	630	1	7	115	26	0,5	590
2		8	120	26	9	590	55-65-80
3		8	120	26	18,5	590	55-65-80
4		8	120	26	28	590	55-65-80
5		8	130	26	37,5	590	55-65-80
6		8	130	26	47	590	55-65-80
8		8	130	26	66	590	55-65-80

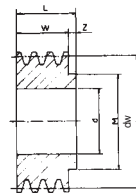

fig. 1

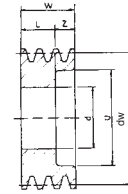

fig. 2

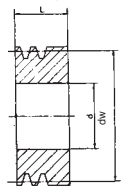

fig. 3

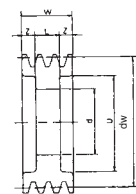

fig. 4

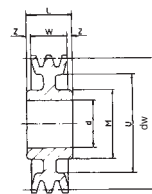

fig. 5

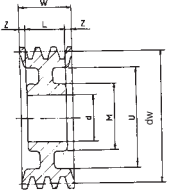

fig. 6

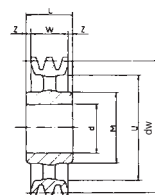

fig. 7

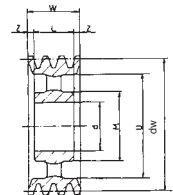

fig. 8

“PCT” SPC-C

Diametro primitivo pitch diameter diamètre primitif Wirkdurchmesser dw [mm]	gole grooves gorges Rillen N°	forma size forme Ausführung fig.	M [mm]	L [mm]	Z [mm]	U [mm]	d H8 [mm]
132	1	2	–	23	11	74	55-65
	2	2	–	26	34	74	55-65
	3	2	–	26	59	74	55-65
	4	4	–	26	42,5	74	55-65
	5	4	–	26	55	74	55-65
140	1	2	–	23	11	82	55-65
	2	2	–	26	34	82	55-65
	3	2	–	26	59	82	55-65
	4	4	–	26	42,5	82	55-65
	5	4	–	26	55	82	55-65
150	1	2	–	26	8	92	55-65-80
	2	2	–	26	34	92	55-65-80
	3	2	–	26	59	92	55-65-80
	4	4	–	26	42,5	92	55-65-80
	5	4	–	26	55	92	55-65-80
160	1	2	–	26	8	102	55-65-80
	2	2	–	26	34	102	55-65-80
	3	2	–	26	59	102	55-65-80
	4	4	–	26	42,5	102	55-65-80
	5	4	–	26	55	102	55-65-80
170	1	2	–	26	8	112	55-65-80
	2	2	–	26	34	112	55-65-80
	3	2	–	26	59	112	55-65-80
	4	4	–	26	42,5	112	55-65-80
	5	4	–	26	55	112	55-65-80
180	1	2	–	26	8	122	55-65-80
	2	2	–	26	34	122	55-65-80
	3	2	–	26	59	122	55-65-80
	4	4	–	26	42,5	122	55-65-80
	5	4	–	26	55	122	55-65-80
190	1	2	–	26	8	132	55-65-80
	2	2	–	26	34	132	55-65-80
	3	2	–	26	59	132	55-65-80
	4	4	–	26	42,5	132	55-65-80
	5	4	–	26	55	132	55-65-80
200	1	6	120	26	4	142	55-65-80
	2	6	120	26	17	142	55-65-80
	3	6	120	26	29,5	142	55-65-80
	4	6	130	26	42,5	142	55-65-80
	5	6	130	26	55	142	55-65-80
212	1	6	120	26	4	154	55-65-80
	2	6	120	26	17	154	55-65-80
	3	6	120	26	29,5	154	55-65-80
	4	6	130	26	42,5	154	55-65-80
	5	6	130	26	55	154	55-65-80
224	1	6	120	26	4	166	55-65-80
	2	6	120	26	17	166	55-65-80
	3	6	120	26	29,5	166	55-65-80
	4	6	130	26	42,5	166	55-65-80
	5	6	130	26	55	166	55-65-80
236	1	6	120	26	4	178	55-65-80
	2	6	120	26	17	178	55-65-80
	3	6	120	26	29,5	178	55-65-80
	4	6	130	26	42,5	178	55-65-80
	5	6	130	26	55	178	55-65-80
250	1	6	120	26	4	192	55-65-80
	2	6	120	26	17	192	55-65-80
	3	6	120	26	29,5	192	55-65-80
	4	6	130	26	42,5	192	55-65-80
	5	6	130	26	55	192	55-65-80

“PCT” SPC-C

W: see Tab. 1

Diametro primitivo pitch diameter diamètre primitif Wirkdurchmesser dw [mm]	gole grooves gorges Rillen N°	forma size forme Ausführung fig.	M [mm]	L [mm]	Z [mm]	U [mm]	d H8 [mm]
280	1	8	120	26	4	222	55-65-80
	2	8	120	26	17	222	55-65-80
	3	8	120	26	29,5	222	55-65-80
	4	6	130	26	42,5	222	55-65-80
	5	6	130	26	55	222	55-65-80
300	1	8	120	26	4	242	55-65-80
	2	8	120	26	17	242	55-65-80
	3	8	120	26	29,5	242	55-65-80
	4	8	130	26	42,5	242	55-65-80
	5	8	130	26	55	242	55-65-80
315	1	8	120	26	4	257	55-65-80
	2	8	120	26	17	257	55-65-80
	3	8	120	26	29,5	257	55-65-80
	4	8	130	26	42,5	257	55-65-80
	5	8	130	26	55	257	55-65-80
355	1	8	120	26	4	297	55-65-80
	2	8	120	26	17	297	55-65-80
	3	8	120	26	29,5	297	55-65-80
	4	8	130	26	42,5	297	55-65-80
	5	8	130	26	55	297	55-65-80
400	1	8	120	26	4	342	55-65-80
	2	8	120	26	17	342	55-65-80
	3	8	120	26	29,5	342	55-65-80
	4	8	130	26	42,5	342	55-65-80
	5	8	130	26	55	342	55-65-80
450	1	8	120	26	4	392	55-65-80
	2	8	120	26	17	392	55-65-80
	3	8	120	26	29,5	392	55-65-80
	4	8	130	26	42,5	392	55-65-80
	5	8	130	26	55	392	55-65-80
500	1	8	120	26	4	442	55-65-80
	2	8	120	26	17	442	55-65-80
	3	8	120	26	29,5	442	55-65-80
	4	8	130	26	42,5	442	55-65-80
	5	8	130	26	55	442	55-65-80



Calettatori per
pulegge PCT

Self-locking units
suitable for PCT
pulleys

Moyeux de serrage
pour poulies PCT

Spannelemente
für Montage PCT
Scheiben



**Calettatore
SIT-LOCK® 8**

**Self-locking unit
SIT-LOCK® 8**

**Moyeux de serrage
SIT-LOCK® 8**

**Spannelemente
SIT-LOCK® 8**

Autocentrante

Self-centering

Auto-centré

Selbstzentrierend

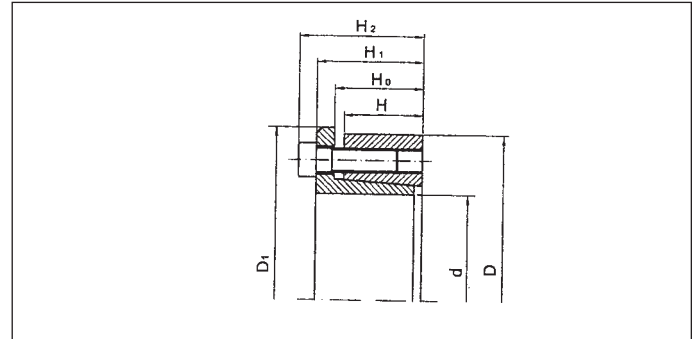

Dimensioni dimensions dimensions Abmessungen						Prestazioni performances performances Leistungen		Pressioni pressure pression Druck		Viti di serraggio clamping screws vis de serrage Befestigungs-Schrauben DIN 912 - 12.9		
d x D [mm]	H [mm]	H ₀ [mm]	H ₁ [mm]	H ₂ [mm]	D ₁ [mm]	M ₁ [daNm]	P _{ax} [daN]	P _w [daN/mm ²]	P _N [daN/mm ²]	N°	size type Typ tipo	M _s [daNm]
14 x 55	17	22	30	38	62	17	2.440	27,5	7	4	M8	2,5
16 x 55	17	22	30	38	62	19	2.440	24	7	4	M8	2,5
18 x 55	17	22	30	38	62	25	2.440	21,5	7	4	M8	2,5
19 x 55	17	22	30	38	62	27	2.440	20,5	7	4	M8	2,5
20 x 55	17	22	30	38	62	28	2.440	19,5	7	4	M8	2,5
22 x 55	17	22	30	38	62	37	3.400	25	10	4	M8	3,5
24 x 55	17	22	30	38	62	40	3.400	23	10	4	M8	3,5
25 x 55	17	22	30	38	62	42	3.400	22	10	4	M8	3,5
28 x 55	17	22	30	38	62	47	3.400	23,5	12	4	M8	4,1
30 x 55	17	22	30	38	62	51	3.400	22	12	4	M8	4,1
24 x 65	17	22	30	38	72	44	3.740	24,5	9	5	M8	3
25 x 65	17	22	30	38	72	46	3.740	23,5	9	5	M8	3
28 x 65	17	22	30	38	72	60	4.360	24,5	10,5	5	M8	3,5
30 x 65	17	22	30	38	72	64	4.360	23	10,5	5	M8	3,5
32 x 65	17	22	30	38	72	69	4.360	21,5	10,5	5	M8	3,5
35 x 65	17	22	30	38	72	91	5.250	23,5	13	5	M8	4,1
38 x 65	17	22	30	38	72	99	5.250	22	13	5	M8	4,1
40 x 65	17	22	30	38	72	105	5.250	20,5	13	5	M8	4,1
30 x 80	20	25	33	41	87	78	5.240	23,5	9	7	M8	3
32 x 80	20	25	33	41	87	83	5.240	22	9	7	M8	3
35 x 80	20	25	33	41	87	106	6.100	23	10	7	M8	3,5
38 x 80	20	25	33	41	87	115	6.100	21,5	10	7	M8	3,5
40 x 80	20	25	33	41	87	122	6.100	20,5	10	7	M8	3,5
42 x 80	20	25	33	41	87	154	7.350	23,5	12	7	M8	4,1
45 x 80	20	25	33	41	87	165	7.350	22	12	7	M8	4,1
48 x 80	20	25	33	41	87	176	7.350	20,5	12	7	M8	4,1
50 x 80	20	25	33	41	87	183	7.350	19,5	12	7	M8	4,1

LEGENDA	LEGEND	LEGENDE	LEGENDE
M _s [daNm]	Coppia di serraggio viti	Screws tightening torque	Couple de serrage des vis
M ₁ [daNm]	Momento torcente trasmissibile	Transmissibile torque	Couple transmissible
P _{ax} [daN]	Forza assiale trasmissibile	Transmissible axial force	Force axiale transmissible
P _w [daN/mm ²]	Pressione esercitata sull'albero	Shaft surface pressure	Pression superficielle sur l'arbre
P _N [daN/mm ²]	Pressione esercitata sul mozzo	Hub surface pressure	Pression superficielle dans l'alesage
			Festzieh-Drehmoment der Schrauben
			Übertragbares Drehmoment
			Übertragbare Axialkraft
			Auf Welle ausgeübter Druck
			Auf Nabe ausgeübter Druck

Tolleranza consigliata per la sede del SIT-LOCK® 8: albero h8 mozzo H8

For SIT-LOCK® 8 we recommend the following fits: h 8 for the shaft - H 8 for the hub

Pour SIT-LOCK® 8 nous recommandons les tolérances suivantes: h 8 pour l'arbre, H 8 pour l'alesage

Für den Sitz von SIT-LOCK® 8 empfohlene Toleranz: Welle h 8 - Nabe H 8



PULEGGE REGOLABILI “PR DV” E “PBR DV”

Le pulegge regolabili “PR DV” e “PBR DV” consentono di variare, da fermo, il diametro primitivo tra un minimo ed un massimo indicato in tabella.

Esse sono adatte per le cinghie trapezoidali nelle sezioni Z - SPZ - 3V; A - SPA; B - SPB - 5V; C - SPC.

Sono costruite in ghisa sia a una (1DV) che a due gole (2DV).

Sono disponibili in due tipologie differenti:

- pulegge “PR DV” con mozzo pieno;
- pulegge “PBR DV” con mozzo predisposto per montaggio con bussola SER-SIT®.

Una delle flange si avvita sul mozzo filettato. La flangia mobile è dotata di grani per il fissaggio nella posizione desiderata. Sarà opportuno una periodica lubrificazione della filettatura.

Per le potenze trasmissibili vedere catalogo cinghie trapezoidali, tenendo conto del diametro minimo.

ADJUSTABLE PULLEYS “PR DV” AND “PBR DV”

Static adjustable pulleys “PR DV” and “PBR DV” are designed to allow adjustment of pitch diameters.

They are suitable for Z - SPZ - 3V; A - SPA; B - SPB - 5V; C - SPC section V-belts.

Both one groove (DV1) and two grooves (DV2) are constructed in high quality cast iron.

Two different pulley constructions are available:

- “PR DV” pulleys with full hub;
- “PBR DV” pulleys for assembly with SER-SIT® conical bushes.

One of the flanges has to be screwed on the threaded hub. The movable flange is provided with grub screws for fixing into required position.

It is advisable to grease the hub threads periodically.

For belt power ratings see our V-Belt catalogue.

POULIES RÉGLABLES “PR DV” ET “PBR DV”

Les poulies réglables “PR DV” et “PBR DV” permettent de varier - à l'arrêt - le diamètre primitif.

Elles sont indiquées pour les courroies trapézoïdales avec section Z - SPZ - 3V; A - SPA; B - SPB - 5V; C - SPC.

Elles sont construites en fonte de qualité soit à une gorge (1 DV) ou à deux gorges (2 DV). Elles sont disponibles en différentes typologies:

- poulies “PR DV” avec moyeu plein;
- poulies “PBR DV” avec moyeu prédisposé pour montage avec moyeu amovible SER-SIT®.

Une des brides se visse sur le moyeu fileté. La bride mobile est munie de vis sans tête pour la fixation dans la position désirée.

Procéder à la lubrification périodique du filetage.

Pour les puissances transmissibles, consulter le catalogue des courroies trapézoïdales en tenant compte du diamètre minimum.

“PR DV” UND “PBR DV” VERSTELLSCHEIBEN

Die Verstell scheiben “PR DV” und “PBR DV” ermöglichen bei stillstehender Übersetzung die Regulierung des Teilkreisdurchmessers.

Sie eignen sich für die Keilriemen mit den Schnitten Z, SPZ, 3V - A, SPA - B, SPB, 5V - C, SPC.

Sie sind aus Gußeisen gefertigt und weisen eine (1 DV) oder zwei (2 DV) Laufrollen auf.

Sie sind in zwei Arten erhältlich:

- “PR DV”- Verstell scheiben mit voller Nabe;
- “PBR DV” - Verstell scheiben mit Nabe, die sich zum Einbau der SER-SIT®-Kegelbuchse eignen.

Einer der Flansche wird mit der Gewindenabe verschraubt. Der bewegliche Flansch ist mit Befestigungsschrauben versehen, mit denen er sich in der gewünschten Stellung festziehen läßt.

Es empfiehlt sich, das Gewinde in regelmäßigen Zeitabständen zu schmieren. Die möglichen Übertragungswerte sind aus dem Keilriemen-Katalog ersichtlich, wobei der Mindestdurchmesser zu berücksichtigen ist.



PULEGGE REGO- LABILI "PR DV"

(mozzo pieno)

ADJUSTABLE PULLEYS "PR DV"

(solid)

POULIES RÉGLABLES "PR DV"

(pleine)

"PR DV" VER- STELLSCHEIBEN

(Vollscheibe)

PR1DV

CODICE CODE CODE BESTELLNUMMER	De [mm]	L [mm]	Cinghia SPZ / SPZ belt / Courroie SPZ / SPZ-Riemen					Cinghia SPA / SPA belt / Courroie SPA / SPA-Riemen					Cinghia SPB / SPB belt / Courroie SPB / SPB-Riemen				
			Dp max [mm]	Dp min [mm]	Campo di variazione Variation range Champ de variation Verstellbereich	G1 [mm]	G2 [mm]	Dp max [mm]	Dp min [mm]	Campo di variazione Variation range Champ de variation Verstellbereich	G1 [mm]	G2 [mm]	Dp max [mm]	Dp min [mm]	Campo di variazione Variation range Champ de variation Verstellbereich	G1 [mm]	G2 [mm]
PR1DV 59	59	36	54	38	1,42	11	13,4	53,4	40	1,34	12,5	14,5	—	—	—	—	—
PR1DV 73	73	40	68	52	1,31	14	16,4	67,4	54	1,25	15,5	17,5	66	60	1,10	16,8	17,7
PR1DV 83	83	46,5	71,5	56	1,27	16,5	18,9	77,4	58	1,33	17	20	76	64	1,19	18,3	20,2
PR1DV 95	95	46,5	83,5	68	1,23	16,5	18,9	89,4	70	1,28	17	20	88	76	1,16	18,3	20,2
PR1DV 105	105	47	90	74,5	1,21	17	19,4	99,4	77	1,29	17	20,5	98	82,5	1,19	18,3	20,7
PR1DV 121	121	48	106	90,5	1,17	17	19,4	115,4	93	1,24	17	20,5	114	98,5	1,16	18,3	20,7
PR1DV 136	136	48	121	105,5	1,15	17	19,4	130,4	108	1,21	17	20,5	129	113,5	1,14	18,3	20,7
PR1DV 152	152	48	137	121,5	1,13	17	19,4	146,4	124	1,18	17	20,5	145	129,5	1,12	18,3	20,7
PR1DV 167	167	48	152	136,5	1,11	17	19,4	161,4	139	1,16	17	20,5	160	144,5	1,11	18,3	20,7
PR1DV 232	232	59,5	206,5	184,5	1,12	25	27,1	220	197	1,12	25	28	221	202,5	1,09	25	28,2

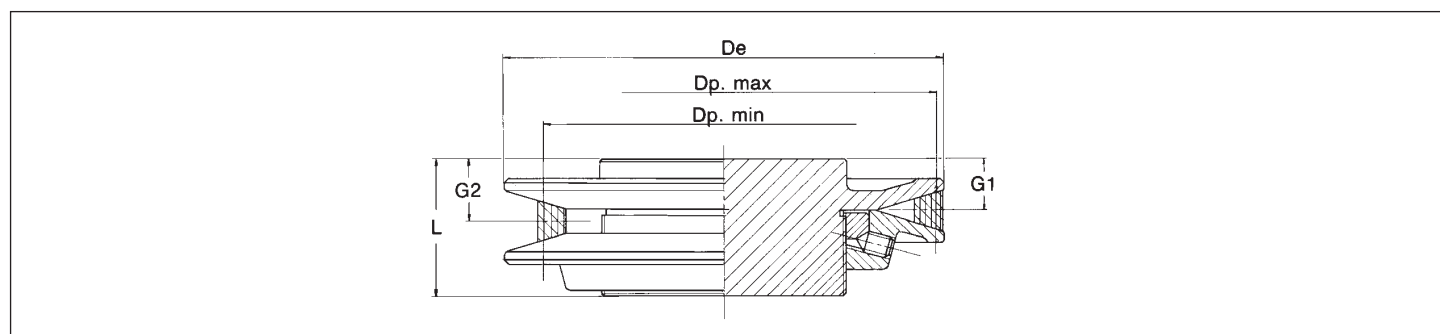

PR2DV

CODICE CODE CODE BESTELLNUMMER	De [mm]	L [mm]	Cinghia SPZ / SPZ belt / Courroie SPZ / SPZ-Riemen					Cinghia SPA / SPA belt / Courroie SPA / SPA-Riemen					Cinghia SPB / SPB belt / Courroie SPB / SPB-Riemen				
			Dp max [mm]	Dp min [mm]	Campo di variazione Variation range Champ de variation Verstellbereich	G1 [mm]	G2 [mm]	Dp max [mm]	Dp min [mm]	Campo di variazione Variation range Champ de variation Verstellbereich	G1 [mm]	G2 [mm]	Dp max [mm]	Dp min [mm]	Campo di variazione Variation range Champ de variation Verstellbereich	G1 [mm]	G2 [mm]
PR2DV 105	105	76	90	74,5	1,21	30	27,6	99,4	77	1,29	30	26,5	98	82,5	1,19	30	27,6
PR2DV 121	121	76	106	90,5	1,17	30	27,6	115,4	93	1,24	30	26,5	114	98,5	1,16	30	27,6
PR2DV 136	136	76	121	105,5	1,15	30	27,6	130,4	108	1,21	30	26,5	129	113,5	1,14	30	27,6
PR2DV 152	152	76	137	121,5	1,13	30	27,6	146,4	124	1,18	30	26,5	145	129,5	1,12	30	27,6
PR2DV 167	167	76	152	136,5	1,11	30	27,6	161,4	139	1,16	30	26,5	160	144,5	1,11	30	27,6
PR2DV 232	232	90	206,5	184,5	1,12	34,5	32,4	220	197	1,12	34,5	31,5	221	202,5	1,09	34,5	31,3

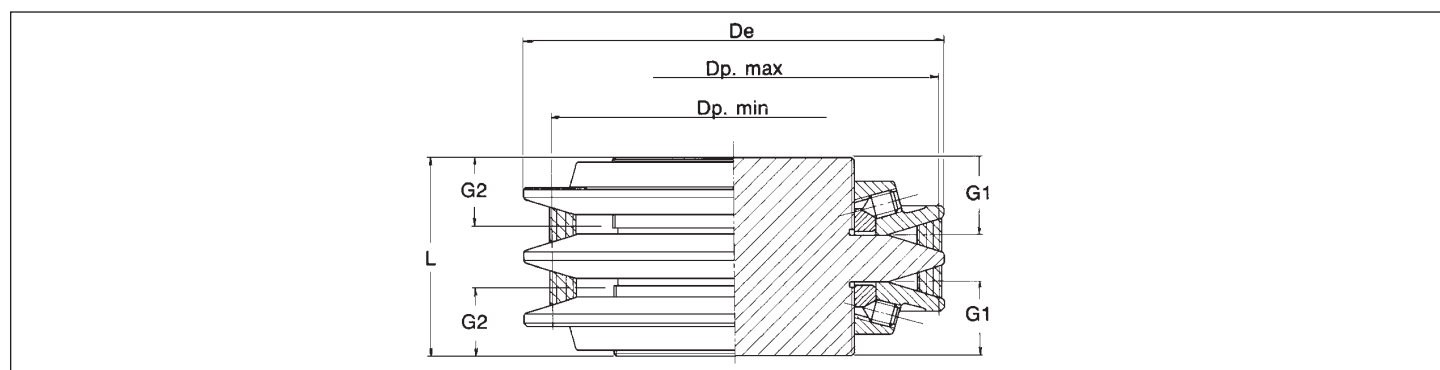

PULEGGE REGO- LABILI "PBR DV"

(mozzo predisposto per bussola conica
SER-SIT®)

ADJUSTABLE PULLEYS "PBR DV"

(for assembly with SER-SIT® taper bush)

POULIES RÉGLA- BLES "PBR DV"

(pour montage avec moyeu amovible
SER-SIT®)

"PBR DV" VERSTELLSCHEIBEN

(mit Nabe für Einbau der SER-SIT® -
Taperbuchse)

PBR1DV

CODICE CODE CODE BESTELLNUMMER	De [mm]	L [mm]	Bussole coniche SER-SIT® SER-SIT® Taper bush moyeu amovible SER-SIT® SER-SIT® Taper buchse	Cinghia SPZ / SPZ belt / Courroie SPZ / SPZ-Riemen				Cinghia SPA / SPA belt / Courroie SPA / SPA-Riemen				Cinghia SPB / SPB belt / Courroie SPB / SPB-Riemen						
				Dp max [mm]	Dp min [mm]	Campo di variazione Variation range Champ de variation Verstell- bereich	G1 [mm]	G2 [mm]	Dp max [mm]	Dp min [mm]	Campo di variazione Variation range Champ de variation Verstell- bereich	G1 [mm]	G2 [mm]	Dp max [mm]	Dp min [mm]	Campo di variazione Variation range Champ de variation Verstell- bereich	G1 [mm]	G2 [mm]
PBR1DV 95	95	39,5	1008 (25.20)	83,5	68	1,23	9,5	11,9	89,4	70	1,28	10	13	88	76	1,16	11,3	13,2
PBR1DV 105	105	40	1108 (28.20)	90	74,5	1,21	10	12,4	99,4	77	1,29	10	13,5	98	82,5	1,19	11,3	13,7
PBR1DV 121	121	41	1108 (28.20)	106	90,5	1,17	10	12,4	115,4	93	1,24	10	13,5	114	98,5	1,16	11,3	13,7
PBR1DV 136	136	41	1210 (30.25)	121	105,5	1,15	10	12,4	130,4	108	1,21	10	13,5	129	113,5	1,14	11,3	13,7
PBR1DV 152	152	41	1610 (40.25)	137	121,5	1,13	10	12,4	146,4	124	1,18	10	13,5	145	129,5	1,12	11,3	13,7
PBR1DV 167	167	41	1610 (40.25)	152	136,5	1,11	10	12,4	161,4	139	1,16	10	13,5	160	144,5	1,11	11,3	13,7
PBR1DV 232	232	47,5	2012 (50.30)	206,5	184,5	1,12	13	15,1	220	197	1,12	13	16	221	202,5	1,09	13	16,2

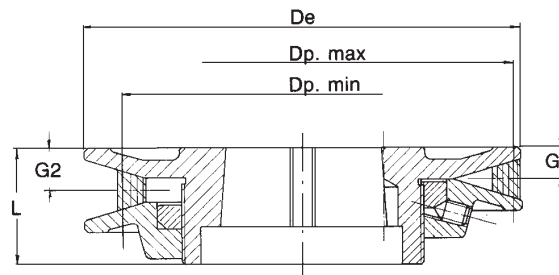

PBR2DV

CODICE CODE CODE BESTELLNUMMER	De [mm]	L [mm]	Z	B	Bussole coniche SER-SIT® SER-SIT® Taper bush moyeu amovible SER-SIT® SER-SIT® Taper buchse	Cinghia SPZ / SPZ belt / Courroie SPZ / SPZ-Riemen				Cinghia SPA / SPA belt / Courroie SPA / SPA-Riemen				Cinghia SPB / SPB belt / Courroie SPB / SPB-Riemen						
						Dp max [mm]	Dp min [mm]	Campo di variazione Variation range Champ de variation Verstell- bereich	G1 [mm]	G2 [mm]	Dp max [mm]	Dp min [mm]	Campo di variazione Variation range Champ de variation Verstell- bereich	G1 [mm]	G2 [mm]	Dp max [mm]	Dp min [mm]	Campo di variazione Variation range Champ de variation Verstell- bereich	G1 [mm]	G2 [mm]
PBR2DV 105	105	76	27	22	1108 (28.20)	90	74,5	1,21	30	27,6	99,4	77	1,29	30	26,5	98	82,5	1,19	30	27,6
PBR2DV 121	121	76	17	42	1215 (30.40)	106	90,5	1,17	30	27,6	115,4	93	1,24	30	26,5	114	98,5	1,16	30	27,6
PBR2DV 136	136	76	17	42	1215 (30.40)	121	105,5	1,15	30	27,6	130,4	108	1,21	30	26,5	129	113,5	1,14	30	27,6
PBR2DV 152	152	76	17	42	1615 (40.40)	137	121,5	1,13	30	27,6	146,4	124	1,18	30	26,5	145	129,5	1,12	30	27,6
PBR2DV 167	167	76	17	42	1615 (40.40)	152	136,5	1,11	30	27,6	161,4	139	1,16	30	26,5	160	144,5	1,11	30	27,6
PBR2DV 232	232	90	21,5	47	2517 (65.45)	206,5	184,5	1,12	34,5	32,4	220	197	1,12	34,5	31,5	221	202,5	1,09	34,5	31,3

