

Timing Pulleys

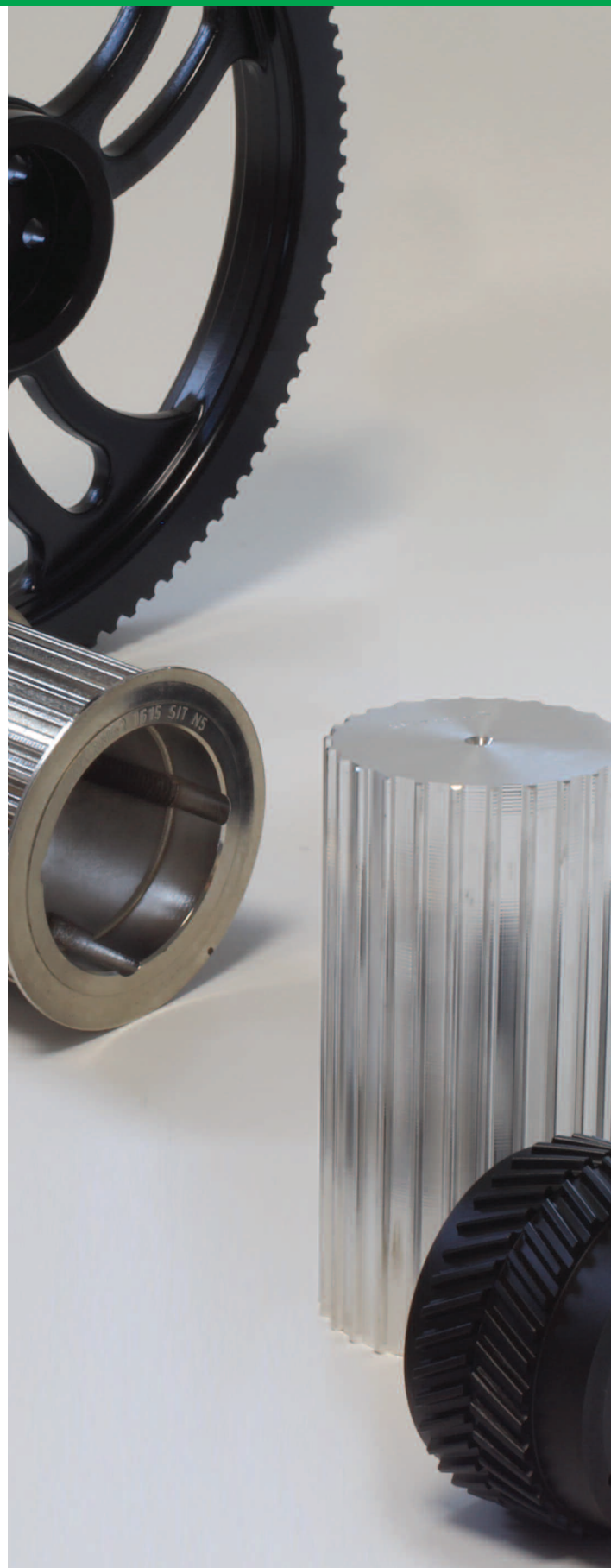

INDEX

SIT TIMING PULLEYS		Page
IMPERIAL PITCH		
Technical data		7
Dimension of pulleys - solid hub		8 ÷ 19
Dimension of pulleys for mounting taper bushing SER-SIT®		20 ÷ 29
METRIC PITCH		
Technical data		30
Dimension of pulleys - solid hub		31 ÷ 34
TOP DRIVE® HTD		
Technical data		35
Dimension of pulleys - solid hub		36 ÷ 42
Dimension of pulleys for mounting taper bushing SER-SIT®		43 ÷ 47
TOP DRIVE® STD		
Technical data		48
Dimension of pulleys - solid hub		49 ÷ 53
Dimension of pulleys for mounting taper bushing SER-SIT®		54 ÷ 57
FALCON GTR		
Technical data		58
Dimension of pulleys for mounting taper bushing SER-SIT®		59 ÷ 67
EAGLE		
Technical data		68
Dimension of pulleys - solid hub		69 ÷ 73
Dimension of pulleys for mounting taper bushing SER-SIT®		74 ÷ 77
EAGLE® aluminum		78 ÷ 82
TIMING BARS		
IMPERIAL PITCH		85
TOP DRIVE® HTD		86
METRIC PITCH pulleys "T"		87
METRIC PITCH pulleys "AT"		88
FLANGES		
Flanges		91 - 92
CLAMP PLATES		
Standard Clamp Plates		95
Raw Clamp Plates		96



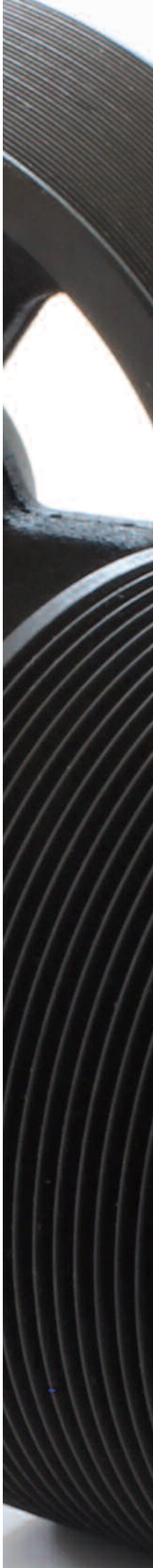

SIT V-PULLEYS	Page
V-PULLEYS	
Technical data	99 ÷ 101
Dimension of pulleys - solid hub	102 ÷ 107
Dimension of pulleys for mounting taper bushing SER-SIT®	108 ÷ 118
Dimension of pulleys for mounting SIT-LOCK® CAL 8	119
SIT-LOCK® CAL 8	120
ADJUSTABLE PULLEYS	
Technical data	123
Dimension of pulleys PR DV - solid hub	124
Dimension of pulleys PBR DV for mounting taper bushing SER-SIT®	125
VARIABLE SPEED PULLEYS	
VAR	129
FIXED	130
Speed range and center distance	131 ÷ 133
POLY-V PULLEYS	Page
Technical data	137
Dimension of pulleys for mounting taper bushing SER-SIT®	138 ÷ 146
COMPONENTS	Page
TAPER BUSHING SER-SIT®	
Description	149
Technical data	150 - 151
SELF LOCKING BUSHING SERLOCK®	
Description	152
Dimension and performances of standard types	153 - 154
MOTOR BASES	Page
MOTOR BASES	
Motor Bases	157 ÷ 162
BELT TENSION AND ALIGNMENT	Page
TEN-SIT® 2.0	
Ten-Sit® 2.0	164 - 165
LINE-LASER®	
Line-Laser®	166

SIT Power Transmission, a history of passion and technology

SIT S.p.A., a core member of the Scaglia Group which was founded nearly 200 years ago in Bergamo Italy, has a 50 years history dedicated to manufacturing and supplying power transmission products.

This experience fuels innovative design and high quality reliable products confirmed by our ISO 9001, ATEX and ROHS certifications. Due to its winning mix of human creativity and technology, SIT is recognized as an industry leader.

With its worldwide distribution network, SIT is able to offer customers technical drive design assistance and consultation, a full stock range and quick yet precise service.

SIT S.p.A, manufactures and sells the widest range both of belts and pulleys for friction and synchronous drives, keyless self locking units, chain drives, ball bearings, planetary geraboxes, gear and backlash couplings and motor bases, standard and according to customer specifications.

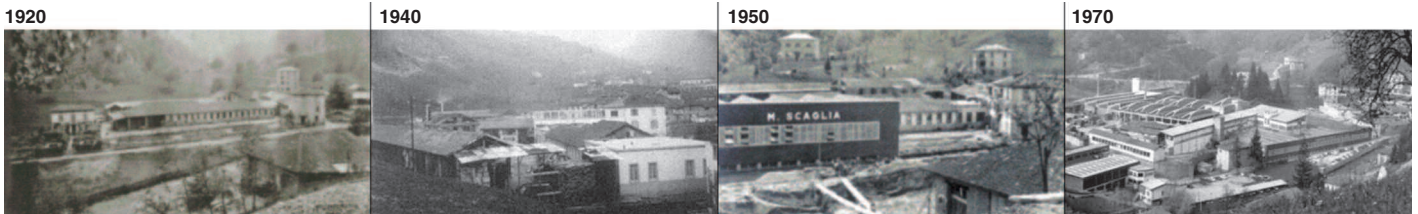

Today

SIT timing pulleys - IMPERIAL PITCH

Timing pulleys IMPERIAL PITCH are available with solid hub execution and for assembly with SER-SIT® taper bushing. These types of pulleys are available in a wide range of pitches and teeth number.

Solid hub

Material: aluminum/cast iron/steel.
Finishing: protective surface treatment.

Pitch:

- XL
- L
- H
- XXH



For mounting taper bushing SER-SIT®

Material: cast iron.
Finishing: protective surface treatment.

Pitch:

- L
- H
- XH



Special executions

Upon request, SIT is able to design and manufacture any type of pulley based on customer requirements.

For peripheral speed exceeding 33 m/s it is strongly recommended to use steel as material of construction.

$$\text{peripheral speed [m/s]} = \frac{\text{pulley diameter [mm]} \cdot \text{rpm}}{19100}$$

In order to reduce the system weight, the pulleys can be manufactured from light metals; in this case the lifetime will be reduced when compared to the standard because the nylon belt coating has a slightly abrasive effect. This disadvantage can be reduced with a high thickness anodization coating of the teeth.

Flanged pulleys

Timing belts, when in motion, have a slight lateral displacement. It is therefore necessary to use at least one flanged pulley to prevent the belt jumping out of the pulley.

Usually, in order to reduce the costs, the flanged pulley is the one with the smaller diameter.

In any case, when the distance of the axes is greater than 8 times the diameter of the small pulley, or when the transmission is working on shafts arranged in a position that is not horizontal, both pulleys have to be flanged.

TOLERANCES

Pulley diameter tolerances

External diameter [mm]	Tolerances [mm]
up to 25,4	+0,05 - 0,00
from 25,4 to 50,8	+0,08 - 0,00
from 50,8 to 101,6	+0,10 - 0,00
from 101,6 to 177,8	+0,13 - 0,00
from 177,8 to 304,8	+0,15 - 0,00
from 304,8 to 508,0	+0,18 - 0,00
from 508,0 to 762,0	+0,20 - 0,00
from 762,0 to 1016,0	+0,23 - 0,00
more than 1016,0	+0,25 - 0,00

Radial circular runout

External diameter [mm]	Measured total eccentricity [mm]
up to 203,2	0,13
more than 203,2	add 0,013 for any 25,4 of diameter

Cylindricity tolerance

Pulley width	Tolerances
for any 100 mm	0,1 mm without exceeding the external diameter tolerance

Protective coating

All (steel and cast iron) pulleys are treated with surface process that gives greater resistance against oxidizing agents. This treatment does not modify the profile or the dimensions of the pulleys.

On request SIT can provide a wide range of special coating, related to the customer specific needs or environmental critical conditions.

Note

Due to a constant improvement of our products, technical data of the pulleys may be subject to changes. For technical and production reasons, in some cases materials other than those indicated in the catalogue may be used. For confirmation of the material actually available, please contact customer service.

Dimensions of timing pulleys IMPERIAL PITCH - solid hub

Pitches XL - L - H - XH - XXH



Part Number	PD 40 XL 037
IMPERIAL PITCH timing pulleys - solid hub	
Number of teeth	
Pitch	
Belt width in inches x 100	

PD ... XL 037

XL

Code	Teeth nr.	Type	E [mm]	R [mm]	S [mm]	U [mm]	H [mm]	d [mm]	W [mm]	Y [mm]	Z [mm]	Flange	Material
PD10XL037	10	1	23,0	16,17	15,66	-	10,0	-	14,3	25,0	10,7	with flanges	aluminum
PD11XL037	11	1	23,0	17,79	17,28	-	10,0	-	14,3	25,0	10,7		
PD12XL037	12	1	25,0	19,40	18,89	-	12,0	-	14,3	25,0	10,7		
PD13XL037	13	1	25,0	21,02	20,51	-	12,0	-	14,3	25,0	10,7		
PD14XL037	14	1	28,0	22,64	22,13	-	15,0	-	14,3	25,0	10,7		
PD15XL037	15	1	28,0	24,25	23,74	-	16,0	-	14,3	25,0	10,7		
PD16XL037	16	1	32,0	25,87	25,36	-	17,0	-	14,3	25,0	10,7		
PD17XL037	17	1	32,0	27,49	26,98	-	20,0	-	14,3	25,0	10,7		
PD18XL037	18	1	35,0	29,11	28,60	-	20,0	-	14,3	25,0	10,7		
PD19XL037	19	1	35,0	30,72	30,21	-	20,0	-	14,3	25,0	10,7		
PD20XL037	20	1	38,0	32,34	31,83	-	24,0	-	14,3	25,0	10,7		
PD21XL037	21	1	38,0	33,96	33,45	-	24,0	-	14,3	25,0	10,7		
PD22XL037	22	1	41,0	35,57	35,06	-	27,0	-	14,3	25,0	10,7		
PD24XL037	24	1	44,0	38,81	38,30	-	30,0	-	14,3	25,0	10,7		
PD25XL037	25	1	44,0	39,93	39,93	-	30,0	-	14,3	25,0	10,7		
PD26XL037	26	1	48,0	42,03	41,53	-	30,0	-	14,3	25,0	10,7		
PD27XL037	27	1	48,0	43,66	43,15	-	32,0	-	14,3	25,0	10,7		
PD28XL037	28	1	51,0	45,28	44,77	-	34,0	-	14,3	25,0	10,7		
PD29XL037	29	1	51,0	46,89	46,38	-	34,0	-	14,3	25,0	10,7		
PD30XL037	30	1	54,0	48,51	48,00	-	38,0	-	14,3	25,0	10,7		
PD32XL037	32	1A	-	51,74	51,23	-	45,0	-	14,3	25,0	10,7		
PD34XL037	34	1A	-	54,98	54,47	-	45,0	-	14,3	25,0	10,7		
PD35XL037	35	1A	-	56,60	56,09	-	45,0	-	14,3	25,0	10,7		
PD36XL037	36	1A	-	58,21	57,70	-	52,0	-	14,3	25,0	10,7		
PD38XL037	38	1A	-	61,45	60,94	-	52,0	-	14,3	25,0	10,7		
PD39XL037	39	1A	-	63,06	62,55	-	52,0	-	14,3	25,0	10,7		
PD40XL037	40	1A	-	64,68	64,17	-	52,0	-	14,3	25,0	10,7		
PD41XL037	41	1A	-	66,30	65,79	-	52,0	-	14,3	25,0	10,7		
PD42XL037	42	1A	-	67,91	67,40	-	52,0	-	14,3	25,0	10,7		
PD43XL037	43	1A	-	69,53	69,02	-	52,0	-	14,3	25,0	10,7		
PD44XL037	44	1A	-	71,15	70,64	-	52,0	-	14,3	25,0	10,7		
PD45XL037	45	1A	-	72,77	72,26	-	52,0	-	14,3	25,0	10,7		
PD46XL037	46	1A	-	74,38	73,87	-	52,0	-	14,3	25,0	10,7		
PD47XL037	47	1A	-	76,00	75,49	-	52,0	-	14,3	25,0	10,7		
PD48XL037	48	1A	-	77,62	77,11	-	52,0	-	14,3	25,0	10,7		
PD49XL037	49	3A	-	79,23	78,72	54,0	52,0	-	14,3	25,0	10,7		
PD52XL037	52	3A	-	84,08	83,57	58,0	52,0	-	14,3	25,0	10,7		
PD56XL037	56	3A	-	90,55	90,04	65,0	52,0	-	14,3	25,0	10,7		
PD57XL037	57	3A	-	92,17	91,66	67,0	52,0	-	14,3	25,0	10,7		
PD58XL037	58	3A	-	93,79	93,28	69,0	52,0	-	14,3	25,0	10,7		
PD59XL037	59	3A	-	95,40	94,89	70,0	52,0	-	14,3	25,0	10,7		
PD60XL037	60	3A	-	97,02	96,51	71,0	52,0	-	14,3	25,0	10,7		
PD68XL037	68	3A	-	109,96	109,45	84,0	52,0	-	14,3	25,0	10,7		
PD69XL037	69	3A	-	111,57	111,06	85,0	52,0	-	14,3	25,0	10,7		
PD70XL037	70	3A	-	113,19	112,68	87,0	52,0	-	14,3	25,0	10,7		
PD71XL037	71	3A	-	114,81	114,30	89,0	52,0	-	14,3	25,0	10,7		
PD72XL037	72	3A	-	116,43	115,92	91,0	52,0	-	14,3	25,0	10,7		

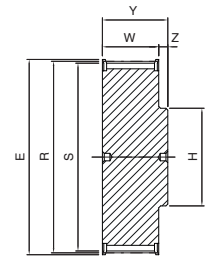

1

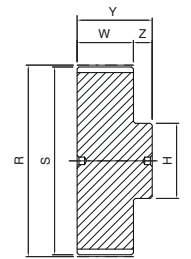

1A

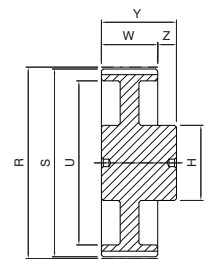

3A

Dimensions of timing pulleys IMPERIAL PITCH - solid hub



PD ... L 050

L

Code	Teeth nr.	Type	E [mm]	R [mm]	S [mm]	U [mm]	H [mm]	d [mm]	W [mm]	Y [mm]	Z [mm]	Flange	Material
PD10L050	10	1	37,0	30,32	29,56	-	20,0	-	19,0	30,0	11,0	with flanges	steel
PD11L050	11	1	37,0	33,35	32,59	-	20,0	-	19,0	30,0	11,0		
PD12L050	12	1	43,0	36,38	35,62	-	27,0	-	19,0	30,0	11,0		
PD13L050	13	1	44,0	39,41	38,65	-	27,0	-	19,0	30,0	11,0		
PD14L050	14	1	48,0	42,45	41,69	-	29,0	-	19,0	30,0	11,0		
PD15L050	15	1	51,0	45,48	44,72	-	32,0	-	19,0	30,0	11,0		
PD16L050	16	1	54,0	48,51	47,75	-	37,0	-	19,0	30,0	11,0		
PD17L050	17	1	57,0	51,54	50,78	-	37,0	-	19,0	30,0	11,0		
PD18L050	18	1	60,0	54,57	53,81	-	41,0	-	19,0	30,0	11,0		
PD19L050	19	1	64,0	57,61	56,84	-	41,0	-	19,0	30,0	11,0		
PD20L050	20	1	66,5	60,64	59,88	-	47,0	-	19,0	30,0	11,0		
PD21L050	21	1	70,0	63,67	62,91	-	47,0	-	19,0	30,0	11,0		
PD22L050	22	1	75,0	66,70	65,94	-	50,0	-	19,0	30,0	11,0		
PD23L050	23	1	79,0	69,73	68,97	-	50,0	-	19,0	30,0	11,0		
PD24L050	24	1	79,0	72,77	72,01	-	55,0	-	19,0	32,0	13,0		
PD25L050	25	1	82,5	75,80	75,04	-	58,0	-	19,0	32,0	13,0		
PD26L050	26	1	86,0	78,83	78,07	-	64,0	-	19,0	32,0	13,0		
PD27L050	27	1	86,0	81,86	81,10	-	64,0	-	19,0	32,0	13,0		
PD28L050	28	1	91,0	84,89	84,13	-	70,0	-	19,0	32,0	13,0		
PD29L050	29	1	94,0	87,93	87,16	-	70,0	-	19,0	32,0	13,0		
PD30L050	30	1	97,0	90,96	90,20	-	72,0	-	19,0	34,0	15,0		
PD32L050	32	1	102,0	97,02	96,26	-	75,0	-	19,0	34,0	15,0		
PD33L050	33	1	106,0	100,05	99,29	-	80,0	-	19,0	34,0	15,0		
PD34L050	34	1	112,0	103,08	102,32	-	85,0	-	19,0	34,0	15,0		
PD35L050	35	1	112,0	106,12	105,35	-	88,0	-	19,0	34,0	15,0		
PD36L050	36	1	115,0	109,15	108,39	-	88,0	-	19,0	34,0	15,0		
PD40L050	40	3	128,0	121,28	120,52	100,0	68,0	11,0	19,0	34,0	15,0		
PD41L050	41	3	128,0	124,31	123,55	103,0	68,0	11,0	19,0	34,0	15,0		
PD42L050	42	3	135,0	127,34	126,58	106,0	68,0	11,0	19,0	34,0	15,0		
PD44L050	44	3	142,0	133,40	132,64	112,0	68,0	11,0	19,0	34,0	15,0		
PD45L050	45	3	142,0	136,44	135,67	115,0	68,0	11,0	19,0	34,0	15,0		
PD47L050	47	3	150,0	142,50	141,74	121,0	68,0	11,0	19,0	34,0	15,0		
PD48L050	48	3	150,0	145,53	144,77	124,0	68,0	11,0	19,0	46,0	27,0		
PD49L050	49	3A	-	148,56	147,80	127,0	68,0	12,0	19,0	46,0	27,0		
PD50L050	50	3A	-	151,60	150,83	130,0	68,0	12,0	19,0	46,0	27,0		
PD52L050	52	3A	-	157,66	156,90	136,0	68,0	12,0	19,0	46,0	27,0		
PD56L050	56	3A	-	169,79	169,02	139,0	68,0	12,0	19,0	46,0	27,0		
PD57L050	57	3A	-	172,82	172,06	152,0	68,0	12,0	19,0	46,0	27,0		
PD60L050	60	3A	-	181,91	181,15	160,0	68,0	12,0	19,0	46,0	27,0		
PD65L050	65	3A	-	197,07	196,31	176,0	68,0	12,0	19,0	46,0	27,0		
PD66L050	66	3A	-	200,11	199,34	179,0	68,0	12,0	19,0	46,0	27,0		
PD72L050	72	3A	-	218,30	217,54	197,0	75,0	12,0	19,0	46,0	27,0		
PD84L050	84	3A	-	254,68	253,92	233,0	75,0	12,0	19,0	46,0	27,0		
PD90L050	90	3A	-	272,87	272,11	252,0	75,0	12,0	19,0	46,0	27,0		
PD96L050	96	3A	-	291,06	290,30	270,0	80,0	12,0	19,0	46,0	27,0		
PD120L050	120	5B	-	363,83	363,07	342,0	85,0	18,0	19,0	46,0	27,0		

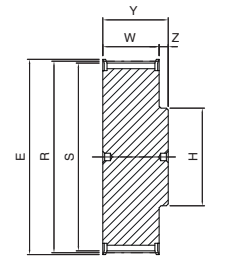

1

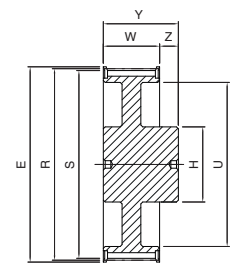

3*

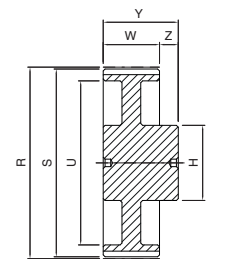

3A*

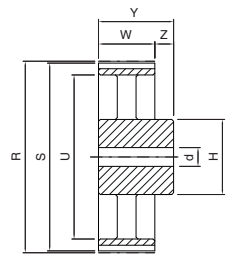

5B

* = A prebore, with a maximum diameter "d", might be present.

Dimensions of timing pulleys IMPERIAL PITCH - solid hub



PD ... L 075

L

Code	Teeth nr.	Type	E [mm]	R [mm]	S [mm]	U [mm]	H [mm]	d [mm]	W [mm]	Y [mm]	Z [mm]	Flange	Material
PD10L075	10	1	37,0	30,32	29,56	-	20,0	-	25,4	38,0	12,6	with flanges	steel
PD11L075	11	1	37,0	33,35	32,59	-	20,0	-	25,4	38,0	12,6		
PD12L075	12	1	43,0	36,38	35,62	-	27,0	-	25,4	38,0	12,6		
PD13L075	13	1	44,0	39,41	38,65	-	27,0	-	25,4	38,0	12,6		
PD14L075	14	1	48,0	42,45	41,69	-	29,0	-	25,4	38,0	12,6		
PD15L075	15	1	51,0	45,48	44,72	-	32,0	-	25,4	38,0	12,6		
PD16L075	16	1	54,0	48,51	47,75	-	37,0	-	25,4	38,0	12,6		
PD17L075	17	1	57,0	51,54	50,78	-	37,0	-	25,4	38,0	12,6		
PD18L075	18	1	60,0	54,57	53,81	-	41,0	-	25,4	38,0	12,6		
PD19L075	19	1	64,0	57,61	56,84	-	41,0	-	25,4	38,0	12,6		
PD20L075	20	1	66,5	60,64	59,88	-	47,0	-	25,4	38,0	12,6		
PD21L075	21	1	70,0	63,67	62,91	-	47,0	-	25,4	38,0	12,6		
PD22L075	22	1	75,0	66,70	65,94	-	50,0	-	25,4	38,0	12,6		
PD23L075	23	1	79,0	69,73	68,97	-	50,0	-	25,4	38,0	12,6		
PD24L075	24	1	79,0	72,77	72,01	-	57,0	-	25,4	38,0	12,6		
PD25L075	25	1	83,0	75,80	75,04	-	58,0	-	25,4	38,0	12,6		
PD26L075	26	1	87,0	78,83	78,07	-	64,0	-	25,4	38,0	12,6		
PD27L075	27	1	87,0	81,86	81,10	-	64,0	-	25,4	38,0	12,6		
PD28L075	28	1	91,0	84,89	84,13	-	70,0	-	25,4	38,0	12,6		
PD29L075	29	1	93,0	87,93	87,16	-	70,0	-	25,4	38,0	12,6		
PD30L075	30	1	97,0	90,96	90,20	-	72,0	-	25,4	38,0	12,6		
PD32L075	32	1	102,0	97,02	96,26	-	75,0	-	25,4	38,0	12,6		
PD33L075	33	1	106,0	100,05	99,29	-	80,0	-	25,4	38,0	12,6		
PD34L075	34	1	112,0	103,08	102,32	-	85,0	-	25,4	38,0	12,6		
PD35L075	35	1	112,0	106,12	105,35	-	88,0	-	25,4	38,0	12,6		
PD36L075	36	1	128,0	109,15	108,39	-	88,0	-	25,4	38,0	12,6		
PD40L075	40	3	128,0	121,28	120,52	100,0	68,0	11,0	25,4	38,0	12,6		
PD41L075	41	3	128,0	124,31	123,55	103,0	68,0	11,0	25,4	38,0	12,6		
PD42L075	42	3	135,0	127,34	126,58	106,0	68,0	11,0	25,4	38,0	12,6		
PD44L075	44	3	142,0	133,40	132,64	112,0	68,0	11,0	25,4	38,0	12,6		
PD45L075	45	3	150,0	136,44	135,67	115,0	68,0	11,0	25,4	38,0	12,6		
PD47L075	47	3	150,0	142,50	141,74	121,0	68,0	11,0	25,4	38,0	12,6		
PD48L075	48	3	150,0	145,53	144,77	124,0	68,0	11,0	25,4	48,0	22,6		
PD49L075	49	3A	-	148,56	147,80	127,0	68,0	12,0	25,4	48,0	22,6		
PD50L075	50	3A	-	151,60	150,83	130,0	68,0	12,0	25,4	48,0	22,6		
PD52L075	52	3A	-	157,66	156,90	136,0	68,0	12,0	25,4	48,0	22,6		
PD56L075	56	3A	-	169,79	169,02	139,0	68,0	12,0	25,4	48,0	22,6		
PD57L075	57	3A	-	172,82	172,06	152,0	68,0	12,0	25,4	48,0	22,6		
PD60L075	60	3A	-	181,91	181,15	160,0	68,0	12,0	25,4	48,0	22,6		
PD65L075	65	3A	-	197,07	196,31	176,0	68,0	12,0	25,4	48,0	22,6		
PD66L075	66	3A	-	200,11	199,34	179,0	68,0	12,0	25,4	48,0	22,6		
PD72L075	72	3A	-	218,30	217,54	197,0	75,0	12,0	25,4	48,0	22,6		
PD84L075	84	3A	-	254,68	253,92	233,0	75,0	12,0	25,4	48,0	22,6		
PD90L075	90	3A	-	272,87	272,11	252,0	75,0	12,0	25,4	48,0	22,6		
PD96L075	96	3A	-	291,06	290,30	270,0	80,0	12,0	25,4	48,0	22,6		
PD120L075	120	5B	-	363,83	363,07	342,0	85,0	18,0	25,4	48,0	22,6		

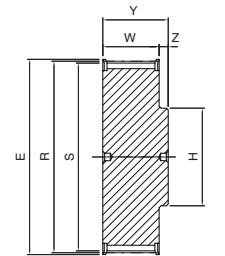

1

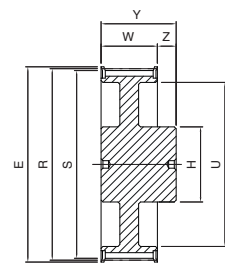

3*

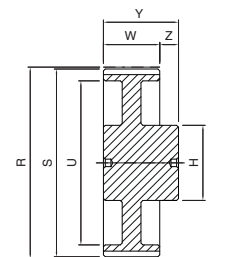

3A*

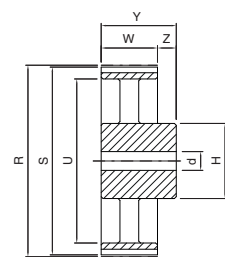

5B

* = A prebore, with a maximum diameter "d", might be present.

Dimensions of timing pulleys IMPERIAL PITCH - solid hub



PD ... L 100

L

Code	Teeth nr.	Type	E [mm]	R [mm]	S [mm]	U [mm]	H [mm]	d [mm]	W [mm]	Y [mm]	Z [mm]	Flange	Material
PD10L100	10	1	37,0	30,32	29,56	-	20,0	-	32,0	46,0	14,0	with flanges	steel
PD11L100	11	1	37,0	33,35	32,59	-	20,0	-	32,0	46,0	14,0		
PD12L100	12	1	43,0	36,38	35,62	-	27,0	-	32,0	46,0	14,0		
PD13L100	13	1	44,0	39,41	38,65	-	27,0	-	32,0	46,0	14,0		
PD14L100	14	1	48,0	42,45	41,69	-	29,0	-	32,0	46,0	14,0		
PD15L100	15	1	51,0	45,48	44,72	-	32,0	-	32,0	46,0	14,0		
PD16L100	16	1	54,0	48,51	47,75	-	37,0	-	32,0	46,0	14,0		
PD17L100	17	1	57,0	51,54	50,78	-	37,0	-	32,0	46,0	14,0		
PD18L100	18	1	60,0	54,57	53,81	-	41,0	-	32,0	46,0	14,0		
PD19L100	19	1	64,0	57,61	56,84	-	41,0	-	32,0	46,0	14,0		
PD20L100	20	1	66,5	60,64	59,88	-	47,0	-	32,0	46,0	14,0		
PD21L100	21	1	70,0	63,67	62,91	-	47,0	-	32,0	46,0	14,0		
PD22L100	22	1	75,0	66,70	65,94	-	50,0	-	32,0	46,0	14,0		
PD23L100	23	1	79,0	69,73	68,97	-	50,0	-	32,0	46,0	14,0		
PD24L100	24	1	79,0	72,77	72,01	-	57,0	-	32,0	46,0	14,0		
PD25L100	25	1	82,5	75,80	75,04	-	58,0	-	32,0	46,0	14,0		
PD26L100	26	1	86,0	78,83	78,07	-	64,0	-	32,0	46,0	14,0		
PD27L100	27	1	86,0	81,86	81,10	-	64,0	-	32,0	46,0	14,0		
PD28L100	28	1	91,0	84,89	84,13	-	70,0	-	32,0	46,0	14,0		
PD29L100	29	1	93,0	87,93	87,16	-	70,0	-	32,0	46,0	14,0		
PD30L100	30	1	97,0	90,96	90,20	-	72,0	-	32,0	46,0	14,0		
PD32L100	32	1	102,0	97,02	96,26	-	75,0	-	32,0	46,0	14,0		
PD33L100	33	1	106,0	100,05	99,29	-	80,0	-	32,0	46,0	14,0		
PD34L100	34	1	112,0	103,08	102,32	-	85,0	-	32,0	46,0	14,0		
PD35L100	35	1	112,0	106,12	105,35	-	88,0	-	32,0	46,0	14,0		
PD36L100	36	1	115,0	109,15	108,39	-	88,0	-	32,0	46,0	14,0		
PD40L100	40	3	128,0	121,28	120,52	100,0	68,0	11,0	32,0	46,0	14,0		
PD41L100	41	3	128,0	124,31	123,55	103,0	68,0	11,0	32,0	46,0	14,0		
PD42L100	42	3	135,0	127,34	126,58	106,0	68,0	11,0	32,0	46,0	14,0		
PD44L100	44	3	142,0	133,40	132,64	112,0	68,0	11,0	32,0	46,0	14,0		
PD45L100	45	3	142,0	136,44	135,67	115,0	68,0	11,0	32,0	46,0	14,0		
PD47L100	47	3	150,0	142,50	141,74	121,0	68,0	11,0	32,0	46,0	14,0		
PD48L100	48	3	150,0	145,53	144,77	124,0	68,0	11,0	32,0	50,0	18,0		
PD49L100	49	3A	-	148,56	147,80	127,0	68,0	12,0	32,0	50,0	18,0		
PD50L100	50	3A	-	151,60	150,83	130,0	68,0	12,0	32,0	50,0	18,0		
PD52L100	52	3A	-	157,66	156,90	136,0	68,0	12,0	32,0	50,0	18,0		
PD56L100	56	3A	-	169,79	169,02	139,0	68,0	12,0	32,0	50,0	18,0		
PD57L100	57	3A	-	172,82	172,06	152,0	68,0	12,0	32,0	50,0	18,0		
PD60L100	60	3A	-	181,91	181,15	160,0	75,0	12,0	32,0	54,0	22,0		
PD65L100	65	3A	-	197,07	196,31	176,0	75,0	12,0	32,0	54,0	22,0		
PD66L100	66	3A	-	200,11	199,34	179,0	75,0	12,0	32,0	54,0	22,0		
PD72L100	72	3A	-	218,30	217,54	197,0	75,0	12,0	32,0	54,0	22,0		
PD84L100	84	3A	-	254,68	253,92	233,0	80,0	12,0	32,0	54,0	22,0		
PD90L100	90	3A	-	272,87	272,11	252,0	80,0	12,0	32,0	54,0	22,0		
PD96L100	96	3A	-	291,06	290,30	270,0	80,0	12,0	32,0	54,0	22,0		
PD120L100	120	5B	-	363,83	363,07	342,0	90,0	18,0	32,0	54,0	22,0		

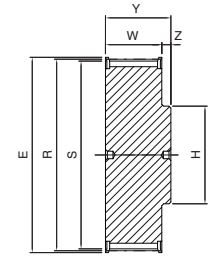

1

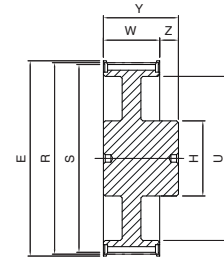

3*

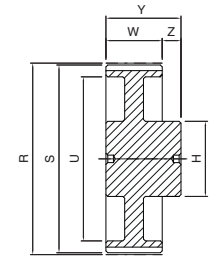

3A*

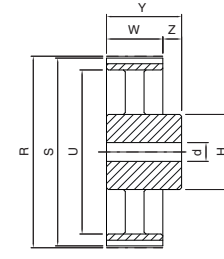

5B

* = A prebore, with a maximum diameter "d", might be present.

Dimensions of timing pulleys IMPERIAL PITCH - solid hub



PD ... H 075

H

Code	Teeth nr.	Type	E [mm]	R [mm]	S [mm]	U [mm]	H [mm]	d [mm]	W [mm]	Y [mm]	Z [mm]	Flange	Material
PD14H075	14	1	64,0	56,60	55,23	-	40,0	-	25,4	38,0	12,6	with flanges	steel
PD15H075	15	1	66,5	60,64	59,27	-	45,0	-	25,4	38,0	12,6		
PD16H075	16	1	70,0	64,68	63,31	-	47,0	-	25,4	38,0	12,6		
PD17H075	17	1	75,0	68,72	67,35	-	49,0	-	25,4	38,0	12,6		
PD18H075	18	1	79,0	72,77	71,40	-	57,0	-	25,4	38,0	12,6		
PD19H075	19	1	82,5	76,81	75,44	-	60,0	-	25,4	38,0	12,6		
PD20H075	20	1	87,0	80,85	79,48	-	64,0	-	25,4	38,0	12,6		
PD21H075	21	1	91,0	84,89	83,52	-	64,0	-	25,4	38,0	12,6		
PD22H075	22	1	94,0	88,94	87,57	-	70,0	-	25,4	38,0	12,6		
PD23H075	23	1	97,0	92,98	91,61	-	72,0	-	25,4	38,0	12,6		
PD24H075	24	1	102,0	97,02	95,65	-	80,0	-	25,4	38,0	12,6		
PD25H075	25	1	106,0	101,06	99,69	-	80,0	-	25,4	38,0	12,6		
PD26H075	26	1	112,0	105,11	103,74	-	85,0	-	25,4	38,0	12,6		
PD27H075	27	1	115,0	109,15	107,78	-	88,0	-	25,4	38,0	12,6		
PD28H075	28	1	120,0	113,19	111,92	-	94,0	-	25,4	38,0	12,6		
PD29H075	29	1	120,0	117,23	115,86	-	96,0	-	25,4	38,0	12,6		
PD30H075	30	1	128,0	121,28	119,91	-	104,0	-	25,4	38,0	12,6		
PD32H075	32	1	135,0	129,36	127,99	-	112,0	-	25,4	38,0	12,6		
PD33H075	33	1	142,0	133,40	132,03	-	112,0	-	25,4	38,0	12,6		
PD34H075	34	1	142,0	137,45	136,08	-	116,0	-	25,4	38,0	12,6		
PD35H075	35	3	150,0	141,49	140,12	118,0	68,0	11,0	25,4	48,0	22,6		
PD36H075	36	3	150,0	145,53	144,16	118,0	68,0	11,0	25,4	48,0	22,6		
PD38H075	38	3	158,0	153,62	152,25	126,0	68,0	11,0	25,4	48,0	22,6		
PD40H075	40	3	168,0	161,70	160,33	134,0	68,0	11,0	25,4	48,0	22,6		
PD44H075	44	3	184,0	177,87	176,50	150,0	68,0	12,0	25,4	48,0	22,6		
PD45H075	45	3	192,0	181,91	180,54	154,0	68,0	12,0	25,4	48,0	22,6		
PD48H075	48	3	200,0	194,04	192,67	166,0	68,0	12,0	25,4	48,0	22,6		
PD49H075	49	3A	-	198,08	196,71	170,0	68,0	12,0	25,4	48,0	22,6		
PD50H075	50	3A	-	202,13	200,76	174,0	68,0	12,0	25,4	48,0	22,6		
PD52H075	52	3A	-	210,21	208,84	182,0	75,0	19,0	25,4	48,0	22,6		
PD60H075	60	3A	-	242,55	241,18	215,0	75,0	19,0	25,4	48,0	22,6		
PD70H075	70	3A	-	282,98	281,61	255,0	75,0	19,0	25,4	48,0	22,6		
PD72H075	72	3A	-	291,06	289,69	263,0	80,0	19,0	25,4	48,0	22,6		
PD82H075	82	5A	-	331,49	330,12	304,0	80,0	19,0	25,4	55,0	29,6		
PD84H075	84	5A	-	339,57	338,20	312,0	90,0	19,0	25,4	55,0	29,6		
PD94H075	94	5A	-	380,00	378,63	352,0	90,0	19,0	25,4	55,0	29,6		
PD96H075	96	5A	-	388,08	386,71	360,0	100,0	19,0	25,4	55,0	29,6		
PD106H075	106	5A	-	428,51	427,14	401,0	100,0	19,0	25,4	55,0	29,6		
PD116H075	116	5A	-	468,93	467,56	441,0	100,0	19,0	25,4	55,0	29,6		
PD118H075	118	5A	-	477,02	475,65	449,0	100,0	19,0	25,4	55,0	29,6		
PD120H075	120	5A	-	485,10	483,73	458,0	100,0	19,0	25,4	55,0	29,6		
PD150H075	150	5A	-	606,38	605,01	579,0	100,0	19,0	25,4	55,0	29,6		
PD152H075	152	5A	-	614,46	613,09	587,0	100,0	19,0	25,4	55,0	29,6		
PD154H075	154	5A	-	622,55	621,17	595,0	100,0	19,0	25,4	55,0	29,6		
PD156H075	156	5A	-	630,63	629,26	603,0	120,0	19,0	25,4	55,0	29,6		

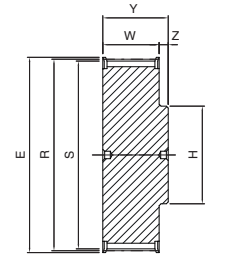

1

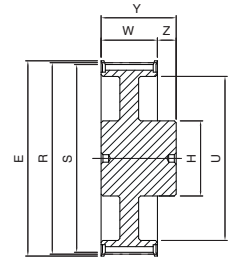

3*

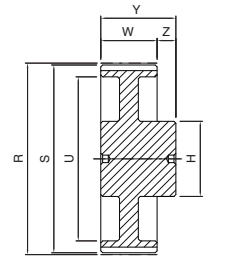

3A*

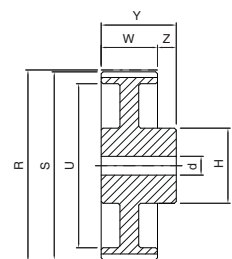

5A

* = A prebore, with a maximum diameter "d", might be present.

Dimensions of timing pulleys IMPERIAL PITCH - solid hub



PD ... H 100

H

Code	Teeth nr.	Type	E [mm]	R [mm]	S [mm]	U [mm]	H [mm]	d [mm]	W [mm]	Y [mm]	Z [mm]	Flange	Material
PD14H100	14	1	64,0	56,60	55,23	-	40,0	-	33,3	44,0	10,7	with flanges	steel
PD15H100	15	1	66,5	60,64	59,27	-	45,0	-	33,3	44,0	10,7		
PD16H100	16	1	70,0	64,68	63,31	-	47,0	-	33,3	44,0	10,7		
PD17H100	17	1	75,0	68,72	67,35	-	49,0	-	33,3	44,0	10,7		
PD18H100	18	1	79,0	72,77	71,40	-	57,0	-	33,3	44,0	10,7		
PD19H100	19	1	82,5	76,81	75,44	-	60,0	-	33,3	44,0	10,7		
PD20H100	20	1	87,0	80,85	79,48	-	64,0	-	33,3	44,0	10,7		
PD21H100	21	1	91,0	84,89	83,52	-	64,0	-	33,3	44,0	10,7		
PD22H100	22	1	94,0	88,94	87,57	-	70,0	-	33,3	44,0	10,7		
PD23H100	23	1	97,0	92,98	91,61	-	72,0	-	33,3	44,0	10,7		
PD24H100	24	1	102,0	97,02	95,65	-	80,0	-	33,3	44,0	10,7		
PD25H100	25	1	106,0	101,06	99,69	-	80,0	-	33,3	44,0	10,7		
PD26H100	26	1	112,0	105,11	103,74	-	85,0	-	33,3	44,0	10,7		
PD27H100	27	1	115,0	109,15	107,78	-	88,0	-	33,3	44,0	10,7		
PD28H100	28	1	120,0	113,19	111,92	-	94,0	-	33,3	48,0	14,7		
PD29H100	29	1	120,0	117,23	115,86	-	96,0	-	33,3	48,0	14,7		
PD30H100	30	1	128,0	121,28	119,91	-	104,0	-	33,3	50,0	16,7		
PD32H100	32	1	135,0	129,36	127,99	-	112,0	-	33,3	52,0	18,7		
PD33H100	33	1	142,0	133,40	132,03	-	112,0	-	33,3	52,0	18,7		
PD34H100	34	1	142,0	137,45	136,08	-	116,0	-	33,3	52,0	18,7		
PD35H100	35	3	150,0	141,49	140,12	118,0	75,0	12,0	33,3	52,0	18,7		
PD36H100	36	3	150,0	145,53	144,16	118,0	75,0	12,0	33,3	52,0	18,7		
PD38H100	38	3	158,0	153,62	152,25	126,0	75,0	12,0	33,3	52,0	18,7		
PD40H100	40	3	168,0	161,70	160,33	134,0	75,0	12,0	33,3	54,0	20,7		
PD44H100	44	3	184,0	177,87	176,50	150,0	75,0	12,0	33,3	54,0	20,7		
PD45H100	45	3	192,0	181,91	180,54	154,0	7,05	12,0	33,3	54,0	20,7		
PD48H100	48	3	200,0	194,04	192,67	166,0	75,0	12,0	33,3	60,0	26,7		
PD49H100	49	3A	-	198,08	196,71	170,0	75,0	12,0	33,3	60,0	26,7		
PD50H100	50	3A	-	202,13	200,76	174,0	75,0	18,0	33,3	60,0	26,7		
PD52H100	52	3A	-	210,21	208,84	182,0	75,0	18,0	33,3	60,0	26,7		
PD60H100	60	3A	-	242,55	241,18	215,0	80,0	18,0	33,3	60,0	26,7		
PD70H100	70	3A	-	282,98	281,61	255,0	80,0	18,0	33,3	60,0	26,7		
PD72H100	72	3A	-	291,06	289,69	263,0	80,0	18,0	33,3	60,0	26,7		
PD82H100	82	5A	-	331,49	330,12	304,0	80,0	18,0	33,3	60,0	26,7		
PD84H100	84	5B	-	339,57	338,20	312,0	90,0	18,0	33,3	60,0	26,7		
PD94H100	94	5B	-	380,00	378,63	352,0	90,0	18,0	33,3	60,0	26,7		
PD96H100	96	5B	-	388,08	386,71	360,0	100,0	18,0	33,3	60,0	26,7		
PD106H100	106	5B	-	428,51	427,14	401,0	100,0	18,0	33,3	60,0	26,7		
PD116H100	116	5B	-	468,93	467,56	441,0	100,0	18,0	33,3	60,0	26,7		
PD118H100	118	5B	-	477,02	475,65	449,0	100,0	18,0	33,3	60,0	26,7		
PD120H100	120	5B	-	485,10	483,73	458,0	100,0	18,0	33,3	60,0	26,7		
PD150H100	150	5B	-	606,38	605,01	579,0	100,0	18,0	33,3	60,0	26,7		
PD152H100	152	5B	-	614,46	613,09	587,0	100,0	18,0	33,3	60,0	26,7		
PD154H100	154	5B	-	622,55	621,17	595,0	100,0	18,0	33,3	60,0	26,7		
PD156H100	156	5B	-	630,63	629,26	603,0	120,0	18,0	33,3	60,0	26,7		

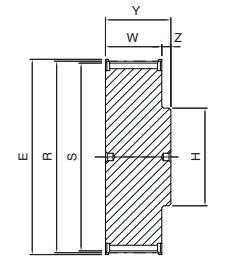

1

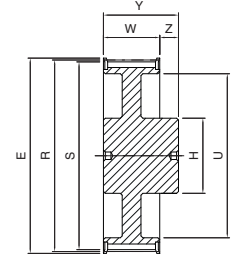

3*

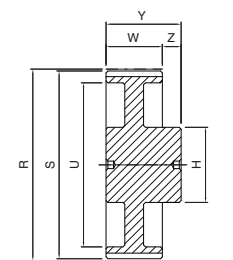

3A*

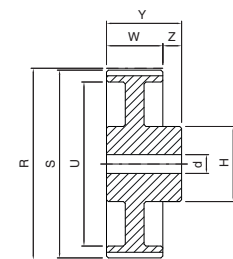

5A

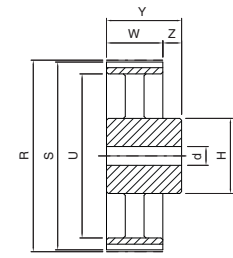

5B

* = A prebore, with a maximum diameter "d", might be present.

Dimensions of timing pulleys IMPERIAL PITCH - solid hub



PD ... H 150

H

Code	Teeth nr.	Type	E [mm]	R [mm]	S [mm]	U [mm]	H [mm]	d [mm]	W [mm]	Y [mm]	Z [mm]	Flange	Material
PD14H150	14	1	64,0	56,60	55,23	-	40,0	-	46,0	58,0	12,0	with flanges	steel
PD15H150	15	1	66,5	60,64	59,27	-	45,0	-	46,0	58,0	12,0		
PD16H150	16	1	70,0	64,68	63,31	-	47,0	-	46,0	58,0	12,0		
PD17H150	17	1	75,0	68,72	67,35	-	49,0	-	46,0	58,0	12,0		
PD18H150	18	1	79,0	72,77	71,40	-	57,0	-	46,0	58,0	12,0		
PD19H150	19	1	82,5	76,81	75,44	-	60,0	-	46,0	58,0	12,0		
PD20H150	20	1	87,0	80,85	79,48	-	64,0	-	46,0	58,0	12,0		
PD21H150	21	1	91,0	84,89	83,52	-	64,0	-	46,0	58,0	12,0		
PD22H150	22	1	94,0	88,94	87,57	-	70,0	-	46,0	58,0	12,0		
PD23H150	23	1	97,0	92,98	91,61	-	72,0	-	46,0	58,0	12,0		
PD24H150	24	1	102,0	97,02	95,65	-	80,0	-	46,0	58,0	12,0		
PD25H150	25	1	106,0	101,06	99,69	-	80,0	-	46,0	58,0	12,0		
PD26H150	26	1	112,0	105,11	103,74	-	85,0	-	46,0	58,0	12,0		
PD27H150	27	1	115,0	109,15	107,78	-	88,0	-	46,0	58,0	12,0		
PD28H150	28	1	120,0	113,19	111,92	-	94,0	-	46,0	58,0	12,0		
PD29H150	29	1	120,0	117,23	115,86	-	96,0	-	46,0	58,0	12,0		
PD30H150	30	1	128,0	121,28	119,91	-	104,0	-	46,0	58,0	12,0		
PD32H150	32	1	135,0	129,36	127,99	-	112,0	-	46,0	58,0	12,0		
PD33H150	33	1	142,0	133,40	132,03	-	112,0	-	46,0	58,0	12,0		
PD34H150	34	1	142,0	137,45	136,08	-	116,0	-	46,0	58,0	12,0		
PD35H150	35	3	150,0	141,49	140,12	118,0	75,0	12,0	46,0	58,0	12,0		
PD36H150	36	3	150,0	145,53	144,16	118,0	75,0	12,0	46,0	58,0	12,0		
PD38H150	38	3	158,0	153,62	152,25	126,0	75,0	12,0	46,0	58,0	12,0		
PD40H150	40	3	168,0	161,70	160,33	134,0	75,0	12,0	46,0	70,0	24,0		
PD44H150	44	3	184,0	177,87	176,50	150,0	75,0	18,0	46,0	70,0	24,0		
PD45H150	45	3	192,0	181,91	180,54	154,0	75,0	18,0	46,0	70,0	24,0		
PD48H150	48	3	200,0	194,04	192,67	166,0	75,0	18,0	46,0	70,0	24,0		
PD49H150	49	3A	-	198,08	196,71	170,0	75,0	18,0	46,0	70,0	24,0		
PD50H150	50	3A	-	202,13	200,76	174,0	75,0	18,0	46,0	70,0	24,0		
PD52H150	52	3A	-	210,21	208,84	182,0	75,0	18,0	46,0	70,0	24,0		
PD58H150	58	3A	-	234,47	233,10	207,0	80,0	-	46,0	70,0	24,0		
PD60H150	60	3A	-	242,55	241,18	215,0	80,0	18,0	46,0	70,0	24,0		
PD70H150	70	3A	-	282,98	281,61	255,0	80,0	24,0	46,0	70,0	24,0		
PD72H150	72	3A	-	291,06	289,69	263,0	80,0	24,0	46,0	70,0	24,0		
PD82H150	82	5B	-	331,49	330,12	304,0	80,0	24,0	46,0	70,0	24,0		
PD84H150	84	5B	-	339,57	338,20	312,0	90,0	24,0	46,0	70,0	24,0		
PD94H150	94	5B	-	380,00	378,63	352,0	90,0	24,0	46,0	70,0	24,0		
PD96H150	96	5B	-	388,08	386,71	360,0	100,0	24,0	46,0	70,0	24,0		
PD106H150	106	5B	-	428,51	427,14	401,0	100,0	24,0	46,0	70,0	24,0		
PD116H150	116	5B	-	468,93	467,56	441,0	100,0	24,0	46,0	70,0	24,0		
PD118H150	118	5B	-	477,02	475,65	449,0	100,0	24,0	46,0	70,0	24,0		
PD120H150	120	5B	-	485,10	483,73	458,0	100,0	24,0	46,0	70,0	24,0		
PD150H150	150	5B	-	606,38	605,01	579,0	100,0	24,0	46,0	70,0	24,0		
PD152H150	152	5B	-	614,46	613,09	587,0	100,0	24,0	46,0	70,0	24,0		
PD154H150	154	5B	-	622,55	621,17	595,0	100,0	24,0	46,0	70,0	24,0		
PD156H150	156	5B	-	630,63	629,26	603,0	120,0	24,0	46,0	70,0	24,0		

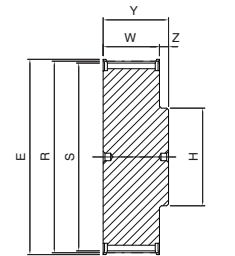

1

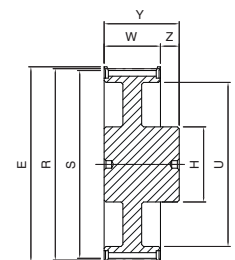

3*

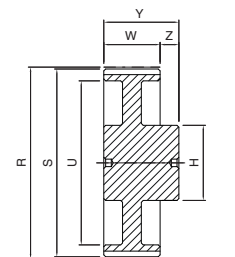

3A*

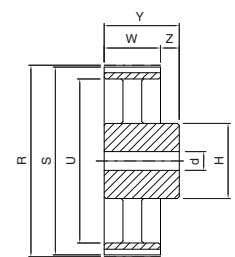

5B

* = A prebore, with a maximum diameter "d", might be present.

Dimensions of timing pulleys IMPERIAL PITCH - solid hub



PD ... H 200

H

Code	Teeth nr.	Type	E [mm]	R [mm]	S [mm]	U [mm]	H [mm]	d [mm]	W [mm]	Y [mm]	Z [mm]	Flange	Material
PD14H200	14	1	64,0	56,60	55,23	-	40,0	-	59,5	72,0	12,5	with flanges	steel
PD15H200	15	1	66,5	60,64	59,27	-	45,0	-	59,5	72,0	12,5		
PD16H200	16	1	70,0	64,68	63,31	-	47,0	-	59,5	72,0	12,5		
PD17H200	17	1	75,0	68,72	67,35	-	49,0	-	59,5	72,0	12,5		
PD18H200	18	1	79,0	72,77	71,40	-	57,0	-	59,5	72,0	12,5		
PD19H200	19	1	82,5	76,81	75,44	-	60,0	-	59,5	72,0	12,5		
PD20H200	20	1	87,0	80,85	79,48	-	64,0	-	59,5	72,0	12,5		
PD21H200	21	1	91,0	84,89	83,52	-	64,0	-	59,5	72,0	12,5		
PD22H200	22	1	94,0	88,94	87,57	-	70,0	-	59,5	72,0	12,5		
PD23H200	23	1	97,0	92,98	91,61	-	72,0	-	59,5	72,0	12,5		
PD24H200	24	1	102,0	97,02	95,65	-	80,0	-	59,5	72,0	12,5		
PD25H200	25	1	106,0	101,06	99,69	-	80,0	-	59,5	72,0	12,5		
PD26H200	26	1	112,0	105,11	103,74	-	85,0	-	59,5	72,0	12,5		
PD27H200	27	1	115,0	109,15	107,78	-	88,0	-	59,5	72,0	12,5		
PD28H200	28	1	120,0	113,19	111,92	-	94,0	-	59,5	72,0	12,5		
PD29H200	29	1	120,0	117,23	115,86	-	96,0	-	59,5	72,0	12,5		
PD30H200	30	1	128,0	121,28	119,91	-	104,0	-	59,5	72,0	12,5		
PD32H200	32	1	135,0	129,36	127,99	-	112,0	-	59,5	72,0	12,5		
PD33H200	33	1	142,0	133,40	132,03	-	112,0	-	59,5	72,0	12,5		
PD34H200	34	1	142,0	137,45	136,08	-	116,0	-	59,5	72,0	12,5		
PD35H200	35	3	150,0	141,49	140,12	118,0	80,0	12,0	59,5	72,0	12,5		
PD36H200	36	3	150,0	145,53	144,16	118,0	80,0	12,0	59,5	72,0	12,5		
PD38H200	38	3	158,0	153,62	152,25	126,0	80,0	12,0	59,5	72,0	12,5		
PD40H200	40	3	168,0	161,70	160,33	134,0	80,0	12,0	59,5	72,0	12,5		
PD44H200	44	3	184,0	177,87	176,50	150,0	80,0	18,0	59,5	72,0	12,5		
PD45H200	45	3	192,0	181,91	180,54	154,0	80,0	18,0	59,5	72,0	12,5		
PD48H200	48	3	200,0	194,04	192,67	166,0	80,0	24,0	59,5	80,0	20,5		
PD49H200	49	3A	-	198,08	196,71	170,0	80,0	24,0	59,5	80,0	20,5		
PD50H200	50	3A	-	202,13	200,76	174,0	80,0	24,0	59,5	80,0	20,5		
PD52H200	52	3A	-	210,21	208,84	182,0	80,0	24,0	59,5	80,0	20,5		
PD58H200	58	3A	-	234,47	233,10	207,0	90,0	-	59,5	80,0	20,5		
PD60H200	60	3A	-	242,55	241,18	215,0	90,0	24,0	59,5	80,0	20,5		
PD70H200	70	3A	-	282,98	281,61	255,0	90,0	28,0	59,5	80,0	20,5		
PD72H200	72	3A	-	291,06	289,69	263,0	90,0	28,0	59,5	80,0	20,5		
PD82H200	82	5B	-	331,49	330,12	304,0	90,0	28,0	59,5	80,0	20,5		
PD84H200	84	5B	-	339,57	338,20	312,0	100,0	28,0	59,5	80,0	20,5		
PD94H200	94	5B	-	380,00	378,63	352,0	100,0	28,0	59,5	80,0	20,5		
PD96H200	96	5B	-	388,08	386,71	360,0	100,0	28,0	59,5	80,0	20,5		
PD106H200	106	5B	-	428,51	427,14	401,0	100,0	28,0	59,5	80,0	20,5		
PD116H200	116	5B	-	468,93	467,56	441,0	100,0	28,0	59,5	80,0	20,5		
PD118H200	118	5B	-	477,02	475,65	449,0	100,0	28,0	59,5	80,0	20,5		
PD120H200	120	5B	-	485,10	483,73	458,0	120,0	28,0	59,5	80,0	20,5		
PD150H200	150	5B	-	606,38	605,01	579,0	120,0	28,0	59,5	80,0	20,5		
PD152H200	152	5B	-	614,46	613,09	587,0	120,0	28,0	59,5	80,0	20,5		
PD154H200	154	5B	-	622,55	621,17	595,0	120,0	28,0	59,5	80,0	20,5		
PD156H200	156	5B	-	630,63	629,26	603,0	130,0	28,0	59,5	80,0	20,5		

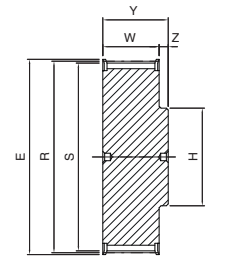

1

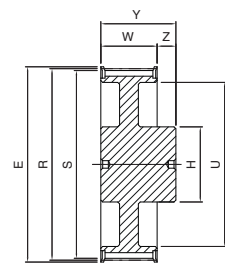

3*

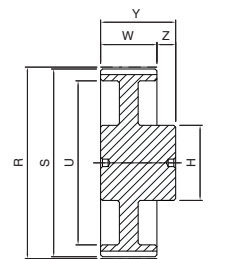

3A*

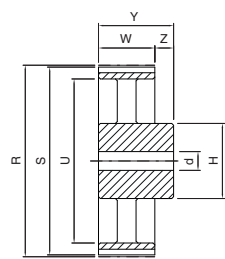

5B

* = A prebore, with a maximum diameter "d", might be present.

Dimensions of timing pulleys IMPERIAL PITCH - solid hub



PD ... H 300

H

Code	Teeth nr.	Type	E [mm]	R [mm]	S [mm]	U [mm]	H [mm]	d [mm]	W [mm]	Y [mm]	Z [mm]	Flange	Material
PD14H300	14	1	64,0	56,60	55,23	-	40,0	-	85,7	98,0	12,3	with flanges	steel
PD15H300	15	1	66,0	60,64	59,27	-	45,0	-	85,7	98,0	12,3		
PD16H300	16	1	70,0	64,68	63,31	-	47,0	-	85,7	98,0	12,3		
PD17H300	17	1	75,0	68,72	67,35	-	49,0	-	85,7	98,0	12,3		
PD18H300	18	1	79,0	72,77	71,40	-	57,0	-	85,7	98,0	12,3		
PD19H300	19	1	83,0	76,81	75,44	-	60,0	-	85,7	98,0	12,3		
PD20H300	20	1	87,0	80,85	79,48	-	64,0	-	85,7	98,0	12,3		
PD21H300	21	1	91,0	84,89	83,52	-	64,0	-	85,7	98,0	12,3		
PD22H300	22	1	93,0	88,94	87,57	-	70,0	-	85,7	98,0	12,3		
PD23H300	23	1	97,0	92,98	91,61	-	72,0	-	85,7	98,0	12,3		
PD24H300	24	1	102,0	97,02	95,65	-	80,0	-	85,7	98,0	12,3		
PD25H300	25	1	106,0	101,06	99,69	-	80,0	-	85,7	98,0	12,3		
PD26H300	26	1	112,0	105,11	103,74	-	85,0	-	85,7	98,0	12,3		
PD27H300	27	1	115,0	109,15	107,78	-	88,0	-	85,7	98,0	12,3		
PD28H300	28	1	120,0	113,19	111,92	-	94,0	-	85,7	98,0	12,3		
PD29H300	29	1	120,0	117,23	115,86	-	96,0	-	85,7	98,0	12,3		
PD30H300	30	1	128,0	121,28	119,91	-	104,0	-	85,7	98,0	12,3		
PD32H300	32	1	135,0	129,36	127,99	-	112,0	-	85,7	98,0	12,3		
PD33H300	33	1	142,0	133,40	132,03	-	112,0	-	85,7	98,0	12,3		
PD34H300	34	1	142,0	137,45	136,08	-	116,0	-	85,7	98,0	12,3		
PD35H300	35	3	150,0	141,49	140,12	118,0	75,0	18,0	85,7	98,0	12,3		
PD36H300	36	3	150,0	145,53	144,16	118,0	80,0	18,0	85,7	98,0	12,3		
PD38H300	38	3	158,0	153,62	152,25	126,0	80,0	18,0	85,7	98,0	12,3		
PD44H300	44	3	184,0	177,87	176,50	150,0	80,0	24,0	85,7	98,0	12,3		
PD45H300	45	3	192,0	181,91	180,54	154,0	80,0	24,0	85,7	98,0	12,3		
PD48H300	48	3	200,0	194,04	192,67	166,0	90,0	24,0	85,7	98,0	12,3		
PD49H300	49	3A	-	198,08	196,71	170,0	90,0	24,0	85,7	98,0	12,3		
PD50H300	50	3A	-	202,13	200,76	174,0	90,0	24,0	85,7	98,0	12,3		
PD52H300	52	3A	-	210,21	208,84	182,0	90,0	24,0	85,7	98,0	12,3		
PD58H300	58	3A	-	234,47	233,10	207,0	100,0	-	85,7	98,0	12,3		
PD60H300	60	3A	-	242,55	241,18	215,0	100,0	24,0	85,7	98,0	12,3		
PD70H300	70	3A	-	282,98	281,61	255,0	100,0	28,0	85,7	98,0	12,3		
PD72H300	72	3A	-	291,06	289,69	263,0	100,0	28,0	85,7	98,0	12,3		
PD82H300	82	5B	-	331,49	330,12	304,0	100,0	28,0	85,7	98,0	12,3		
PD84H300	84	5B	-	339,57	338,20	312,0	100,0	28,0	85,7	98,0	12,3		
PD94H300	94	5B	-	380,00	378,63	352,0	100,0	28,0	85,7	98,0	12,3		
PD96H300	96	5B	-	388,08	386,71	360,0	110,0	28,0	85,7	98,0	12,3		
PD106H300	106	5B	-	428,51	427,14	401,0	110,0	28,0	85,7	98,0	12,3		
PD116H300	116	5B	-	468,93	467,56	441,0	110,0	28,0	85,7	98,0	12,3		
PD118H300	118	5B	-	477,02	475,65	449,0	110,0	28,0	85,7	98,0	12,3		
PD120H300	120	5B	-	485,10	483,73	458,0	120,0	28,0	85,7	98,0	12,3		
PD150H300	150	5B	-	606,38	605,01	579,0	120,0	28,0	85,7	98,0	12,3		
PD152H300	152	5B	-	614,46	613,09	587,0	120,0	28,0	85,7	98,0	12,3		
PD154H300	154	5B	-	622,55	621,17	595,0	120,0	28,0	85,7	98,0	12,3		
PD156H300	156	5B	-	630,63	629,26	603,0	130,0	28,0	85,7	98,0	12,3		

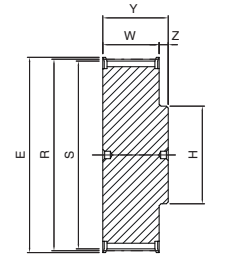

1

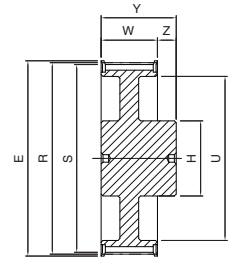

3*

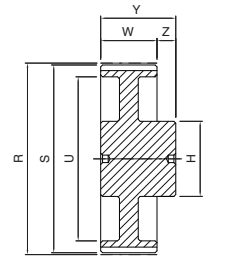

3A*

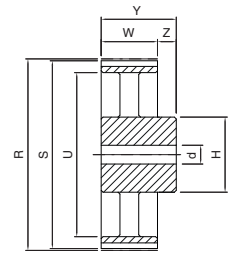

5B

* = A prebore, with a maximum diameter "d", might be present.

Dimensions of timing pulleys IMPERIAL PITCH - solid hub



PD ... XH 200

XH

Code	Teeth nr.	Type	E [mm]	R [mm]	S [mm]	U [mm]	H [mm]	d [mm]	W [mm]	Y [mm]	Z [mm]	Flange	Material
PD18XH200	18	1	134,0	127,34	124,55	-	100,0	-	65,0	80,0	15,0	with flanges	cast iron
PD19XH200	19	1	142,0	134,41	131,62	-	107,0	-	65,0	80,0	15,0		
PD20XH200	20	1	150,0	141,49	138,70	-	114,0	-	65,0	80,0	15,0		
PD21XH200	21	1	158,0	148,56	145,77	-	122,0	-	65,0	80,0	15,0		
PD22XH200	22	1	166,0	155,64	152,85	-	128,0	-	65,0	80,0	15,0		
PD24XH200	24	1	177,0	169,79	167,00	-	141,0	-	65,0	80,0	15,0		
PD25XH200	25	3	186,0	176,86	174,07	-	90,0	-	65,0	80,0	15,0		
PD26XH200	26	3	191,0	183,94	181,15	-	90,0	-	65,0	80,0	15,0		
PD27XH200	27	1	200,0	191,01	188,22	-	158,0	-	65,0	80,0	15,0		
PD28XH200	28	1	209,0	198,08	195,29	-	169,0	-	65,0	80,0	15,0		
PD30XH200	30	3	216,0	212,23	209,44	170,0	110,0	-	65,0	80,0	15,0		
PD32XH200	32	3	232,0	226,38	223,59	184,0	110,0	-	65,0	80,0	15,0		
PD34XH200	34	3	261,0	240,53	237,74	198,0	110,0	-	65,0	80,0	15,0		
PD38XH200	38	3	274,0	268,83	266,03	227,0	110,0	-	65,0	80,0	15,0		
PD40XH200	40	3	288,0	282,98	280,19	241,0	120,0	-	65,0	100,0	35,0		
PD46XH200	46	5	-	325,42	322,63	283,0	120,0	19,0	65,0	100,0	35,0		
PD48XH200	48	5A	-	339,57	336,78	297,0	120,0	19,0	65,0	100,0	35,0		
PD58XH200	58	5A	-	410,32	407,52	368,0	120,0	19,0	65,0	100,0	35,0		
PD60XH200	60	5A	-	424,47	421,68	382,0	130,0	19,0	65,0	100,0	35,0		
PD70XH200	70	5B	-	495,21	492,42	453,0	130,0	19,0	65,0	100,0	35,0		
PD72XH200	72	5B	-	509,36	506,57	467,0	140,0	19,0	65,0	100,0	35,0		
PD78XH200	78	5B	-	551,80	549,01	510,0	140,0	19,0	65,0	100,0	35,0		
PD80XH200	80	5B	-	565,95	563,16	524,0	140,0	19,0	65,0	100,0	35,0		
PD82XH200	82	5B	-	580,10	577,31	538,0	140,0	19,0	65,0	100,0	35,0		
PD84XH200	84	5B	-	594,25	591,46	552,0	150,0	19,0	65,0	100,0	35,0		
PD94XH200	94	5B	-	664,99	662,20	623,0	150,0	19,0	65,0	100,0	35,0		
PD96XH200	96	5B	-	679,14	676,35	637,0	160,0	19,0	65,0	100,0	35,0		
PD118XH200	118	5B	-	834,78	831,99	792,0	160,0	19,0	65,0	100,0	35,0		
PD120XH200	120	5B	-	848,93	846,14	806,0	170,0	19,0	65,0	100,0	35,0		

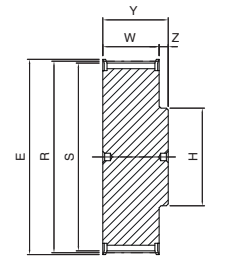

1

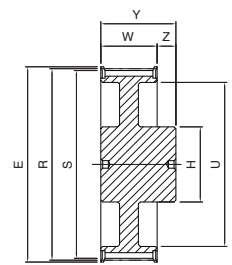

3

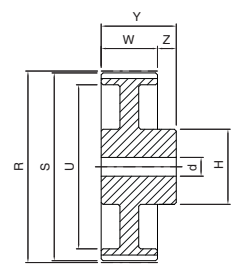

5A

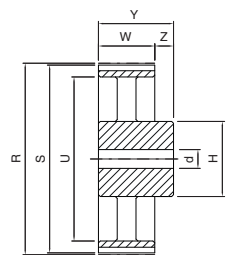

5B

Dimensions of timing pulleys IMPERIAL PITCH - solid hub



PD ... XH 300

XH

Code	Teeth nr.	Type	E [mm]	R [mm]	S [mm]	U [mm]	H [mm]	d [mm]	W [mm]	Y [mm]	Z [mm]	Flange	Material
PD18XH300	18	1	134,0	127,34	124,55	-	100,0	-	92,0	107,0	15,0	with flanges	cast iron
PD19XH300	19	1	142,0	134,41	131,62	-	107,0	-	92,0	107,0	15,0		
PD20XH300	20	1	150,0	141,49	138,70	-	114,0	-	92,0	107,0	15,0		
PD21XH300	21	1	158,0	148,56	145,77	-	122,0	-	92,0	107,0	15,0		
PD22XH300	22	1	166,0	155,64	152,85	-	128,0	-	92,0	107,0	15,0		
PD24XH300	24	1	177,0	169,79	167,00	-	141,0	-	92,0	107,0	15,0		
PD25XH300	25	1	186,0	176,86	174,07	-	148,0	-	92,0	107,0	15,0		
PD26XH300	26	1	191,0	183,94	181,15	-	157,0	-	92,0	107,0	15,0		
PD27XH300	27	1	200,0	191,01	188,22	-	158,0	-	92,0	107,0	15,0		
PD28XH300	28	1	209,0	198,08	195,29	-	169,0	-	92,0	107,0	15,0		
PD30XH300	30	3	216,0	212,23	209,44	170,0	110,0	-	92,0	107,0	15,0		
PD32XH300	32	3	232,0	226,38	223,59	184,0	110,0	-	92,0	107,0	15,0		
PD34XH300	34	3	261,0	240,53	237,74	198,0	110,0	-	92,0	107,0	15,0		
PD38XH300	38	3	274,0	268,83	266,03	227,0	110,0	-	92,0	107,0	15,0		
PD40XH300	40	3	288,0	282,98	280,19	241,0	120,0	-	92,0	100,0	8,0		
PD46XH300	46	5A	-	325,42	322,63	283,0	120,0	19,0	92,0	100,0	8,0		
PD48XH300	48	5A	-	339,57	336,78	297,0	120,0	19,0	92,0	100,0	8,0		
PD58XH300	58	5A	-	410,32	407,52	368,0	120,0	19,0	92,0	100,0	8,0		
PD60XH300	60	5A	-	424,47	421,68	382,0	120,0	19,0	92,0	100,0	8,0		
PD70XH300	70	5B	-	495,21	492,42	453,0	130,0	19,0	92,0	100,0	8,0		
PD72XH300	72	5B	-	509,36	506,57	467,0	140,0	19,0	92,0	120,0	28,0		
PD78XH300	78	5B	-	551,80	549,01	510,0	140,0	19,0	92,0	120,0	28,0		
PD80XH300	80	5B	-	565,95	563,16	524,0	140,0	19,0	92,0	120,0	28,0		
PD82XH300	82	5B	-	580,10	577,31	538,0	140,0	19,0	92,0	120,0	28,0		
PD84XH300	84	5B	-	594,25	591,46	552,0	160,0	19,0	92,0	120,0	28,0		
PD94XH300	94	5B	-	664,99	662,20	623,0	160,0	19,0	92,0	120,0	28,0		
PD96XH300	96	5B	-	679,14	676,35	637,0	160,0	19,0	92,0	120,0	28,0		
PD118XH300	118	5B	-	834,78	831,99	792,0	160,0	19,0	92,0	120,0	28,0		
PD120XH300	120	5B	-	848,93	846,14	806,0	170,0	19,0	92,0	120,0	28,0		

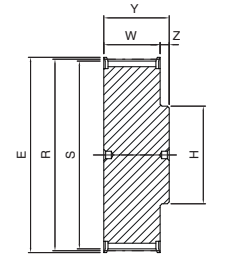

1

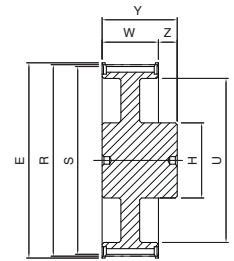

3

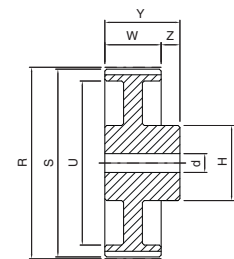

5A

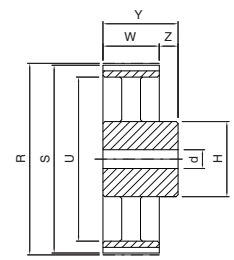

5B

Dimensions of timing pulleys IMPERIAL PITCH - solid hub



PD ... XH400

XH

Code	Teeth nr.	Type	E [mm]	R [mm]	S [mm]	U [mm]	H [mm]	d [mm]	W [mm]	Y [mm]	Z [mm]	Flange	Material
PD18XH400	18	1	134,0	127,34	124,55	-	100,0	-	119,0	135,0	16,0	with flanges	cast iron
PD19XH400	19	1	142,0	134,41	131,62	-	107,0	-	119,0	135,0	16,0		
PD20XH400	20	1	150,0	141,49	138,70	-	114,0	-	119,0	135,0	16,0		
PD21XH400	21	1	158,0	148,56	145,77	-	122,0	-	119,0	135,0	16,0		
PD22XH400	22	1	166,0	155,64	152,85	-	128,0	-	119,0	135,0	16,0		
PD24XH400	24	1	177,0	169,79	167,00	-	141,0	-	119,0	135,0	16,0		
PD25XH400	25	1	186,0	176,86	174,07	-	148,0	-	119,0	135,0	16,0		
PD26XH400	26	1	191,0	183,94	181,15	-	157,0	-	119,0	135,0	16,0		
PD27XH400	27	1	200,0	191,01	188,22	-	158,0	-	119,0	135,0	16,0		
PD28XH400	28	1	209,0	198,08	195,29	-	169,0	-	119,0	135,0	16,0		
PD30XH400	30	3	216,0	212,23	209,44	170,0	120,0	-	119,0	135,0	16,0		
PD32XH400	32	3	232,0	226,38	223,59	184,0	120,0	-	119,0	135,0	16,0		
PD34XH400	34	3	261,0	240,53	237,74	198,0	120,0	-	119,0	135,0	16,0		
PD38XH400	38	3	274,0	268,83	266,03	227,0	120,0	-	119,0	135,0	16,0		
PD40XH400	40	3	288,0	282,98	280,19	241,0	120,0	-	119,0	135,0	16,0		
PD46XH400	46	3A	-	325,42	322,63	283,0	140,0	-	119,0	135,0	16,0		
PD48XH400	48	5A	-	339,57	336,78	297,0	140,0	19,0	119,0	135,0	16,0		
PD58XH400	58	5A	-	410,32	407,52	368,0	140,0	19,0	119,0	135,0	16,0		
PD60XH400	60	5A	-	424,47	421,68	382,0	140,0	19,0	119,0	135,0	16,0		
PD70XH400	70	5B	-	495,21	492,42	453,0	140,0	19,0	119,0	135,0	16,0		
PD72XH400	72	5B	-	509,36	506,57	467,0	140,0	19,0	119,0	135,0	16,0		
PD78XH400	78	5B	-	551,80	549,01	510,0	140,0	19,0	119,0	135,0	16,0		
PD80XH400	80	5B	-	565,95	563,16	524,0	140,0	19,0	119,0	135,0	16,0		
PD82XH400	82	5B	-	580,10	577,31	538,0	140,0	19,0	119,0	135,0	16,0		
PD84XH400	84	5B	-	594,25	591,46	552,0	160,0	19,0	119,0	135,0	16,0		
PD94XH400	94	5B	-	664,99	662,20	623,0	160,0	19,0	119,0	135,0	16,0		
PD96XH400	96	5B	-	679,14	676,35	637,0	160,0	19,0	119,0	135,0	16,0		
PD118XH400	118	5B	-	834,78	831,99	792,0	160,0	19,0	119,0	135,0	16,0		
PD120XH400	120	5B	-	848,93	846,14	806,0	170,0	19,0	119,0	135,0	16,0		

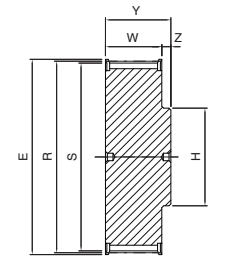

1

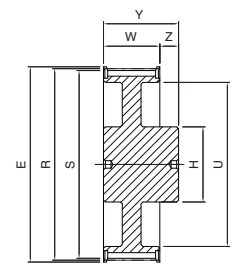

3

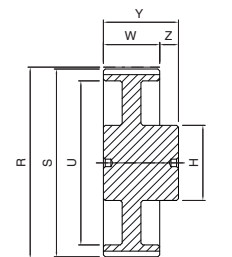

3A

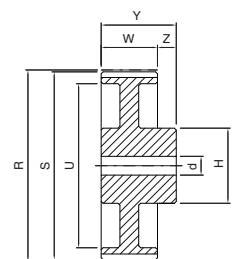

5A

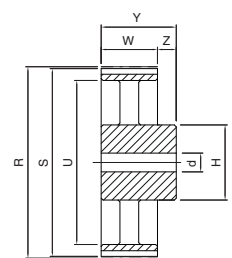

5B

Dimensions of timing pulleys IMPERIAL PITCH - mounting taper bushing SER-SIT®

Pitches L - H - XH



Part Number	PBD 40 L 050
IMPERIAL PITCH timing pulley - mounting taper bushing	
Number of teeth	
Pitch	
Belt width in inches x 100	

PBD ... L050

Code	Teeth nr.	Type	SER-SIT® Taper bushing	E [mm]	R [mm]	S [mm]	U [mm]	H [mm]	W [mm]	Y [mm]	Z [mm]	Flange	Material
PBD18L050	18	2	1108	60,0	54,57	53,81	-	47,0	19,0	22,0	3,0	with flanges	steel
PBD19L050	19	2	1108	64,0	57,61	56,84	-	47,0	19,0	22,0	3,0		
PBD20L050	20	2	1108	66,5	60,64	59,88	-	48,0	19,0	22,0	3,0		
PBD21L050	21	2	1108	70,0	63,67	62,91	-	48,0	19,0	22,0	3,0		
PBD22L050	22	2	1108	75,0	68,70	65,94	-	51,0	19,0	22,0	3,0		
PBD23L050	23	2	1108	79,0	69,73	68,97	-	51,0	19,0	22,0	3,0		
PBD24L050	24	2	1108	79,0	72,77	72,01	-	58,0	19,0	22,0	3,0		
PBD25L050	25	2	1108	82,5	75,80	75,04	-	58,0	19,0	22,0	3,0		
PBD26L050	26	2	1108	86,0	78,83	78,07	-	58,0	19,0	22,0	3,0		
PBD27L050	27	2	1108	86,0	81,86	81,10	-	58,0	19,0	22,0	3,0		
PBD28L050	28	2	1108	91,0	84,89	84,13	-	58,0	19,0	22,0	3,0		
PBD29L050	29	2	1108	94,0	87,93	87,16	-	58,0	19,0	22,0	3,0		
PBD30L050	30	2	1108	97,0	90,96	90,20	-	58,0	19,0	22,0	3,0		
PBD32L050	32	2	1108	102,0	97,02	96,26	-	58,0	19,0	22,0	3,0		
PBD36L050	36	9	1108	115,0	109,15	108,39	84,0	58,0	19,0	22,0	3,0		
PBD40L050	40	2	1610	128,0	121,28	120,52	-	90,0	19,0	25,0	6,0		
PBD44L050	44	9	1610	142,0	133,40	132,64	110,0	90,0	19,0	25,0	6,0		
PBD45L050	45	9	1610	142,0	136,44	135,67	118,0	90,0	19,0	25,0	6,0		
PBD47L050	47	9	1610	150,0	142,50	141,74	126,0	90,0	19,0	25,0	6,0		
PBD48L050	48	9	1610	150,0	145,53	144,77	126,0	90,0	19,0	25,0	6,0		
PBD50L050	50	9A	1610	-	151,60	150,83	132,0	90,0	19,0	25,0	6,0		
PBD56L050	56	9A	1610	-	169,79	169,02	152,0	90,0	19,0	25,0	6,0		
PBD60L050	60	11A	1610	-	181,91	181,15	162,0	90,0	19,0	25,0	3,0		
PBD66L050	66	11B	1610	-	200,11	199,34	178,0	90,0	19,0	25,0	3,0		
PBD72L050	72	11B	1610	-	218,30	217,54	199,0	90,0	19,0	25,0	3,0		
PBD84L050	84	11B	1610	-	254,68	253,92	235,0	90,0	19,0	25,0	3,0		
PBD96L050	96	11B	2012	-	291,06	290,30	270,0	110,0	19,0	32,0	6,5		
PBD120L050	120	11B	2012	-	363,07	344,00	344,0	110,0	19,0	32,0	6,5		

L

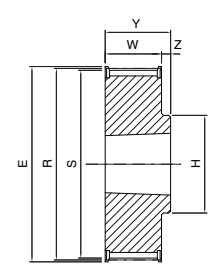

2

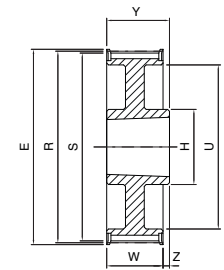

9

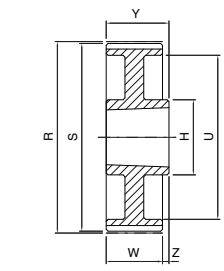

9A

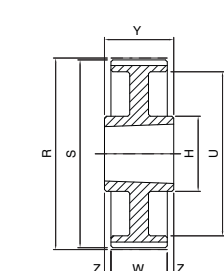

11A

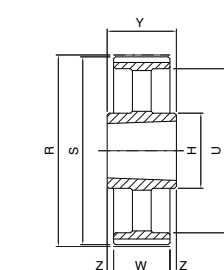

11B

Dimensions of timing pulleys IMPERIAL PITCH - mounting taper bushing SER-SIT®



PBD ... L075

Code	Teeth nr.	Type	SER-SIT® Taper bushing	E [mm]	R [mm]	S [mm]	U [mm]	H [mm]	W [mm]	Y [mm]	Z [mm]	Flange	Material
PBD18L075	18	4	1108	60,0	54,57	53,81	38,0	-	25,0	22,0	3,0	with flanges	steel
PBD19L075	19	4	1108	64,0	57,61	56,84	38,0	-	25,0	22,0	3,0		
PBD20L075	20	4	1108	66,5	60,64	59,88	46,0	-	25,0	22,0	3,0		
PBD21L075	21	4	1108	70,0	63,67	62,91	46,0	-	25,0	22,0	3,0		
PBD22L075	22	4	1108	75,0	68,70	65,94	46,0	-	25,0	22,0	3,0		
PBD23L075	23	4	1108	79,0	69,73	68,97	46,0	-	25,0	22,0	3,0		
PBD24L075	24	4	1108	79,0	72,77	72,01	53,0	-	25,0	22,0	3,0		
PBD25L075	25	4	1108	82,5	75,80	75,04	53,0	-	25,0	22,0	3,0		
PBD26L075	26	4	1108	86,0	78,83	78,07	60,0	-	25,0	22,0	3,0		
PBD27L075	27	4	1108	86,0	81,86	81,10	60,0	-	25,0	22,0	3,0		
PBD28L075	28	4	1108	91,0	84,89	84,13	65,0	-	25,0	22,0	3,0		
PBD30L075	30	4	1108	97,0	90,96	90,20	68,0	-	25,0	22,0	3,0		
PBD32L075	32	4	1108	102,0	97,02	96,26	76,0	-	25,0	22,0	3,0		
PBD34L075	34	4	1108	112,0	103,08	102,32	85,0	-	25,0	22,0	3,0		
PBD36L075	36	6	1610	115,0	109,15	108,39	-	-	25,0	25,0	-		
PBD40L075	40	6	1610	128,0	121,28	120,52	-	-	25,0	25,0	-		
PBD44L075	44	7	1610	142,0	133,40	132,64	110,0	90,0	25,0	25,0	-		
PBD47L075	47	7	1610	150,0	142,50	141,74	126,0	90,0	25,0	25,0	-		
PBD48L075	48	7	1610	150,0	145,53	144,77	126,0	90,0	25,0	25,0	-		
PBD52L075	52	7A	1610	-	157,66	156,90	138,0	90,0	25,0	25,0	-		
PBD57L075	57	7A	1610	-	172,82	172,06	152,0	90,0	25,0	25,0	-		
PBD60L075	60	7A	1610	-	181,91	181,15	162,0	90,0	25,0	25,0	-		
PBD66L075	66	7A	1610	-	200,11	199,34	178,0	90,0	25,0	25,0	-		
PBD72L075	72	7B	1610	-	218,30	217,54	199,0	90,0	25,0	25,0	-		
PBD84L075	84	11B	2012	-	254,68	253,92	235,0	110,0	25,0	32,0	3,5		
PBD96L075	96	11B	2012	-	291,06	290,30	270,0	110,0	25,0	32,0	3,5		
PBD120L075	120	11B	2012	-	363,83	363,07	344,0	110,0	25,0	32,0	3,5		

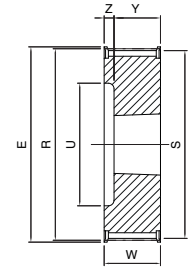

4

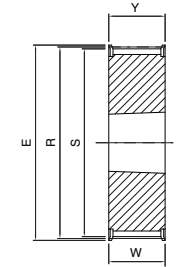

6

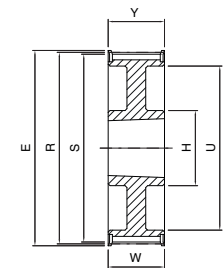

7

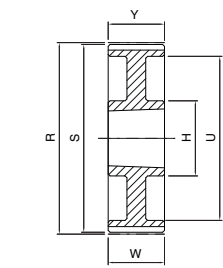

7A

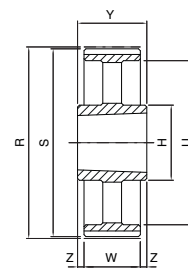

11B

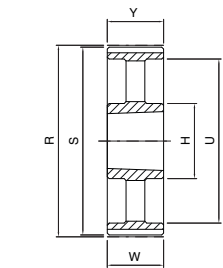

7B

Dimensions of timing pulleys IMPERIAL PITCH - mounting taper bushing SER-SIT®



PBD ... L100

L

Code	Teeth nr.	Type	SER-SIT® Taper bushing	E [mm]	R [mm]	S [mm]	U [mm]	H [mm]	W [mm]	Y [mm]	Z [mm]	Flange	Material
PBD18L100	18	4	1108	60,0	54,57	53,81	38,0	-	32,0	22,0	10,0	with flanges	steel
PBD19L100	19	4	1108	64,0	57,61	56,84	38,0	-	32,0	22,0	10,0		
PBD20L100	20	4	1108	66,5	60,64	59,88	46,0	-	32,0	22,0	10,0		
PBD21L100	21	4	1108	70,0	63,67	62,91	46,0	-	32,0	22,0	10,0		
PBD22L100	22	4	1108	75,0	68,70	65,94	46,0	-	32,0	22,0	10,0		
PBD23L100	23	4	1108	79,0	69,73	68,97	46,0	-	32,0	22,0	10,0		
PBD24L100	24	4	1108	79,0	72,77	72,01	53,0	-	32,0	22,0	10,0		
PBD25L100	25	4	1108	82,5	75,80	75,04	53,0	-	32,0	22,0	10,0		
PBD26L100	26	4	1108	86,0	78,83	78,07	60,0	-	32,0	22,0	10,0		
PBD27L100	27	4	1108	86,0	81,86	81,10	60,0	-	32,0	22,0	10,0		
PBD28L100	28	4	1108	91,0	84,89	84,13	65,0	-	32,0	22,0	10,0		
PBD30L100	30	4	1210	97,0	90,96	90,20	68,0	-	32,0	25,0	7,0		
PBD32L100	32	4	1210	102,0	97,02	96,26	76,0	-	32,0	25,0	7,0		
PBD36L100	36	4	1610	115,0	109,15	108,39	85,0	-	32,0	25,0	7,0		
PBD40L100	40	4	1610	128,0	121,28	120,52	100,0	-	32,0	25,0	7,0		
PBD41L100	41	4	1610	128,0	124,31	123,55	100,0	-	32,0	25,0	7,0		
PBD42L100	42	10	1610	142,0	127,34	126,58	110,0	90,0	32,0	25,0	7,0		
PBD44L100	44	10	1610	142,0	133,40	132,64	110,0	90,0	32,0	25,0	7,0		
PBD48L100	48	10	1610	150,0	145,53	144,77	126,0	90,0	32,0	25,0	7,0		
PBD60L100	60	8A	1610	-	181,91	181,15	162,0	90,0	32,0	25,0	3,5		
PBD72L100	72	7A	2012	-	218,30	217,54	199,0	110,0	32,0	32,0	-	without flanges	cast iron
PBD84L100	84	7B	2012	-	254,68	253,92	235,0	110,0	32,0	32,0	-		
PBD96L100	96	7B	2012	-	291,06	290,30	270,0	110,0	32,0	32,0	-		
PBD120L100	120	7B	2012	-	363,83	363,07	344,0	110,0	32,0	32,0	-		

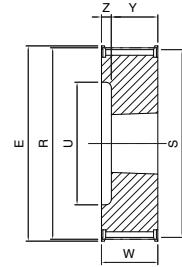

4

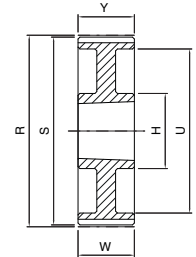

7A

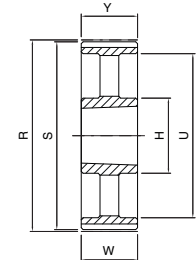

7B

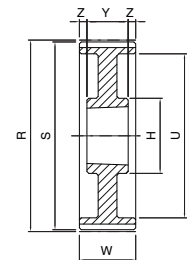

8A

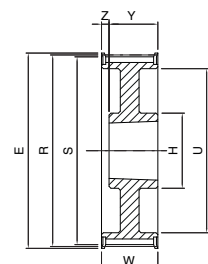

10

Dimensions of timing pulleys IMPERIAL PITCH - mounting taper bushing SER-SIT®



PBD ... H100

H

Code	Teeth nr.	Type	SER-SIT® Taper bushing	E [mm]	R [mm]	S [mm]	U [mm]	H [mm]	W [mm]	Y [mm]	Z [mm]	Flange	Material
PBD14H100	14	4	1108	64,0	56,60	55,23	37,0	-	31,0	22,0	9,0	with flanges	steel
PBD15H100	15	4	1108	66,5	60,64	59,27	37,0	-	31,0	22,0	9,0		
PBD16H100	16	4	1108	70,0	64,68	63,31	46,0	-	31,0	22,0	9,0		
PBD17H100	17	4	1210	75,0	68,72	67,35	46,0	-	31,0	25,0	6,0		
PBD18H100	18	4	1210	79,0	72,77	71,40	56,0	-	31,0	25,0	6,0		
PBD19H100	19	4	1210	82,5	76,81	75,44	56,0	-	31,0	25,0	6,0		
PBD20H100	20	4	1210	87,0	80,85	79,48	56,0	-	31,0	25,0	6,0		
PBD21H100	21	4	1210	91,0	84,89	83,52	62,0	-	32,0	25,0	7,0		
PBD22H100	22	4	1210	94,0	88,94	87,57	62,0	-	32,0	25,0	7,0		
PBD23H100	23	4	1610	97,0	92,98	91,61	71,0	-	32,0	25,0	7,0		
PBD24H100	24	4	1610	102,0	97,02	95,65	71,0	-	32,0	25,0	7,0		
PBD25H100	25	4	1610	106,0	101,06	99,69	78,0	-	32,0	25,0	7,0		
PBD26H100	26	4	1610	112,0	105,11	103,74	78,0	-	32,0	25,0	7,0		
PBD27H100	27	4	1610	115,0	109,15	107,78	86,0	-	32,0	25,0	7,0		
PBD28H100	28	4	1610	120,0	113,19	111,92	86,0	-	32,0	25,0	7,0		
PBD30H100	30	4	1610	128,0	121,28	119,91	95,0	-	32,0	25,0	7,0		
PBD32H100	32	10	1610	135,0	129,36	127,99	110,0	82,0	32,0	25,0	7,0		
PBD33H100	33	10	1615	137,0	133,40	132,03	112,0	82,0	32,0	25,0	-		
PBD34H100	34	10	1610	142,0	137,45	136,08	112,0	82,0	32,0	25,0	7,0		
PBD35H100	35	10	1610	150,0	141,49	140,12	120,0	82,0	32,0	25,0	7,0		
PBD36H100	36	10	1610	150,0	145,53	144,16	120,0	82,0	32,0	25,0	7,0		
PBD38H100	38	10	1610	158,0	153,62	152,25	136,0	82,0	32,0	25,0	7,0		
PBD40H100	40	10	1610	168,0	161,70	160,33	136,0	90,0	32,0	25,0	7,0		
PBD44H100	44	7	2012	184,0	177,87	176,50	162,0	110,0	32,0	32,0	-		
PBD45H100	45	7	2012	192,0	181,91	180,54	162,0	110,0	32,0	32,0	-		
PBD48H100	48	7	2012	200,0	194,04	192,67	168,0	110,0	32,0	32,0	-		
PBD50H100	50	8A	2012	-	202,13	200,76	172,0	110,0	34,0	32,0	1,0	without flanges	cast iron
PBD52H100	52	8A	2012	-	210,21	208,84	185,0	110,0	34,0	32,0	1,0		
PBD60H100	60	8A	2012	-	242,55	241,18	217,0	110,0	34,0	32,0	1,0		
PBD70H100	70	8B	2012	-	282,98	281,61	264,0	110,0	34,0	32,0	1,0		
PBD72H100	72	8B	2012	-	291,06	289,69	264,0	110,0	34,0	32,0	1,0		
PBD84H100	84	8B	2012	-	339,57	338,20	312,0	120,0	34,0	32,0	1,0		
PBD96H100	96	11B	2517	-	388,08	386,71	357,0	120,0	34,0	45,0	5,5		
PBD106H100	106	11B	2517	-	428,51	427,14	402,0	120,0	34,0	45,0	5,5		
PBD120H100	120	11B	2517	-	485,10	483,73	457,0	120,0	34,0	45,0	5,5		

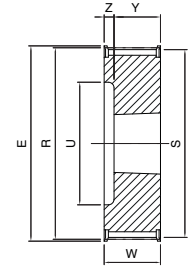

4

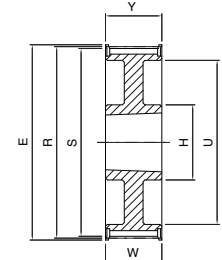

7

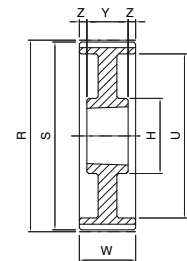

8A

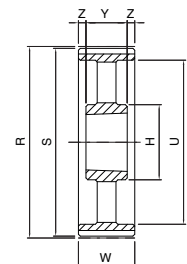

8B

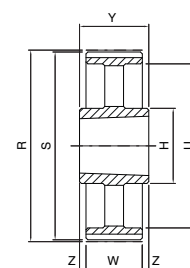

11B

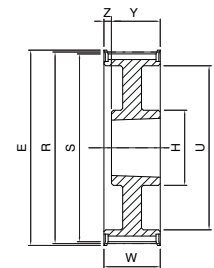

10

Dimensions of timing pulleys IMPERIAL PITCH - mounting taper bushing SER-SIT®



PBD ... H150

H

Code	Teeth nr.	Type	SER-SIT® Taper bushing	E [mm]	R [mm]	S [mm]	U [mm]	H [mm]	W [mm]	Y [mm]	Z [mm]	Flange	Material
PBD14H150	14	4	1108	64,0	56,60	55,23	37,0	-	45,0	22,0	23,0	with flanges	steel
PBD16H150	16	4	1108	70,0	64,68	63,31	46,0	-	45,0	22,0	23,0		
PBD18H150	18	4	1210	79,0	72,77	71,40	56,0	-	45,0	25,0	20,0		
PBD19H150	19	4	1210	82,5	76,81	75,44	56,0	-	45,0	25,0	20,0		
PBD20H150	20	4	1210	87,0	80,85	79,48	56,0	-	45,0	25,0	20,0		
PBD21H150	21	4	1210	91,0	84,89	83,52	67,0	-	45,0	25,0	20,0		
PBD22H150	22	4	1210	94,0	88,94	87,57	67,0	-	45,0	25,0	20,0		
PBD23H150	23	4	1610	97,0	92,98	91,61	71,0	-	45,0	25,0	20,0		
PBD24H150	24	4	1610	102,0	97,02	95,65	71,0	-	45,0	25,0	20,0		
PBD25H150	25	4	1610	106,0	101,06	99,69	78,0	-	45,0	25,0	20,0		
PBD26H150	26	4	1610	112,0	105,11	103,74	78,0	-	45,0	25,0	20,0		
PBD27H150	27	4	1610	115,0	109,15	107,78	86,0	-	45,0	25,0	20,0		
PBD28H150	28	4	1610	120,0	113,19	111,92	86,0	-	45,0	25,0	20,0		
PBD30H150	30	4	1610	128,0	121,28	119,91	95,0	-	45,0	25,0	20,0		
PBD32H150	32	10	1610	135,0	129,36	127,99	110,0	82,0	45,0	25,0	20,0		
PBD35H150	35	10	1610	150,0	141,49	140,12	120,0	82,0	45,0	25,0	20,0		
PBD36H150	36	10	1610	150,0	145,53	144,16	120,0	82,0	45,0	25,0	20,0		
PBD40H150	40	10	1610	168,0	161,70	160,33	136,0	90,0	45,0	25,0	20,0		
PBD44H150	44	10	2012	184,0	177,87	176,50	152,0	110,0	45,0	32,0	13,0		
PBD45H150	45	10	2012	192,0	181,91	180,54	162,0	110,0	45,0	32,0	13,0		
PBD48H150	48	10	2012	200,0	194,04	192,67	168,0	110,0	45,0	32,0	13,0		
PBD60H150	60	8B	2012	-	242,55	241,18	217,0	110,0	46,0	32,0	7,0		
PBD70H150	70	8B	2012	-	282,98	281,61	264,0	110,0	46,0	32,0	7,0		
PBD72H150	72	8B	2012	-	291,06	289,69	264,0	110,0	46,0	32,0	7,0		
PBD82H150	82	8B	2012	-	331,49	330,12	312,0	110,0	46,0	32,0	7,0		
PBD84H150	84	8B	2012	-	339,57	338,20	312,0	110,0	46,0	32,0	7,0		
PBD94H150	94	8B	2517	-	380,00	378,63	357,0	120,0	46,0	45,0	0,5		
PBD96H150	96	8B	2517	-	388,08	386,71	357,0	120,0	46,0	45,0	0,5		
PBD106H150	106	8B	2517	-	428,51	427,14	402,0	120,0	46,0	45,0	0,5		
PBD120H150	120	8B	2517	-	485,10	483,73	457,0	120,0	46,0	45,0	0,5		

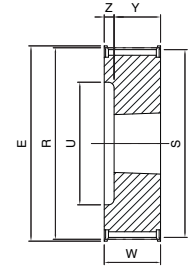

4

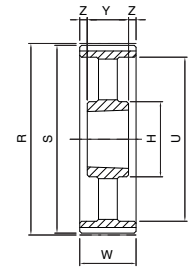

8B

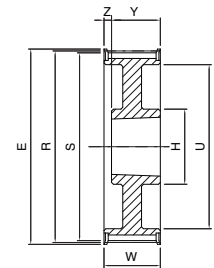

10

Dimensions of timing pulleys IMPERIAL PITCH - mounting taper bushing SER-SIT®



PBD ... H200

H

Code	Teeth nr.	Type	SER-SIT® Taper bushing	E [mm]	R [mm]	S [mm]	U [mm]	H [mm]	W [mm]	Y [mm]	Z [mm]	Flange	Material
PBD16H200	16	4	1108	70,0	64,68	63,31	46,0	-	58,0	22,0	36,0	with flanges	steel
PBD18H200	18	4	1210	79,0	72,77	71,40	52,0	-	58,0	25,0	33,0		
PBD19H200	19	4	1610	82,5	76,81	75,44	56,0	-	58,0	25,0	33,0		
PBD20H200	20	4	1610	87,0	80,85	79,48	56,0	-	58,0	25,0	33,0		
PBD21H200	21	4	1610	91,0	84,89	83,52	67,0	-	58,0	25,0	33,0		
PBD22H200	22	4	1610	94,0	88,94	87,57	67,0	-	58,0	25,0	33,0		
PBD23H200	23	4	1610	97,0	92,98	91,61	71,0	-	58,0	25,0	33,0		
PBD24H200	24	4	1610	102,0	97,02	95,65	71,0	-	58,0	25,0	33,0		
PBD25H200	25	4	1610	106,0	101,06	99,69	78,0	-	58,0	25,0	33,0		
PBD26H200	26	4	1610	112,0	105,11	103,74	78,0	-	58,0	25,0	33,0		
PBD27H200	27	4	1610	115,0	109,15	107,78	86,0	-	58,0	25,0	33,0		
PBD28H200	28	4	1610	120,0	113,19	111,92	86,0	-	58,0	25,0	33,0		
PBD30H200	30	4	1610	128,0	121,28	119,91	95,0	-	58,0	25,0	33,0		
PBD32H200	32	4	2012	135,0	129,36	127,99	106,0	-	58,0	32,0	26,0		
PBD35H200	35	10	2012	150,0	141,49	140,12	120,0	102,0	58,0	32,0	26,0		
PBD36H200	36	10	2012	150,0	145,53	144,16	120,0	102,0	58,0	32,0	26,0		
PBD40H200	40	10	2012	168,0	161,70	160,33	136,0	110,0	58,0	32,0	26,0		
PBD44H200	44	10	2012	184,0	177,87	176,50	162,0	110,0	58,0	32,0	26,0		
PBD48H200	48	10	2517	200,0	194,04	192,67	168,0	120,0	58,0	45,0	13,0		
PBD50H200	50	8A	2517	-	202,13	200,76	172,0	120,0	60,0	45,0	7,5	without flanges	cast iron
PBD52H200	52	8A	2517	-	210,21	208,84	185,0	120,0	60,0	45,0	7,5		
PBD60H200	60	8B	2517	-	242,55	241,18	217,0	120,0	60,0	45,0	7,5		
PBD70H200	70	8B	2517	-	282,98	281,61	264,0	120,0	60,0	45,0	7,5		
PBD72H200	72	8B	2517	-	291,06	289,69	264,0	120,0	60,0	45,0	7,5		
PBD82H200	82	8B	2517	-	331,49	330,12	312,0	120,0	60,0	45,0	7,5		
PBD84H200	84	8B	2517	-	339,57	338,20	312,0	120,0	60,0	45,0	7,5		
PBD94H200	94	8B	2517	-	380,00	378,63	357,0	120,0	60,0	45,0	7,5		
PBD96H200	96	8B	2517	-	388,08	386,71	357,0	120,0	60,0	45,0	7,5		
PBD106H200	106	8B	2517	-	428,51	427,14	402,0	120,0	60,0	45,0	7,5		
PBD116H200	116	8B	2517	-	468,93	467,56	442,0	120,0	60,0	45,0	7,5		
PBD120H200	120	8B	2517	-	485,10	483,73	457,0	120,0	60,0	45,0	7,5		

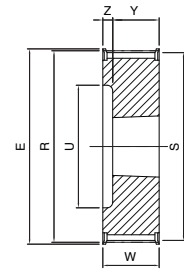

4

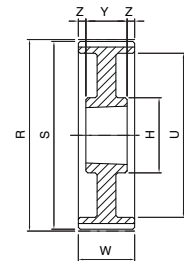

8A

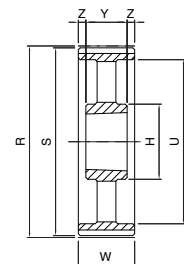

8B

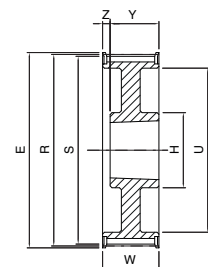

10

Dimensions of timing pulleys IMPERIAL PITCH - mounting taper bushing SER-SIT®



PBD ... H300

H

Code	Teeth nr.	Type	SER-SIT® Taper bushing	E [mm]	R [mm]	S [mm]	U [mm]	H [mm]	W [mm]	Y [mm]	Z [mm]	Flange	Material
PBD19H300	19	5	1215	82,5	76,81	75,44	56,0	-	84,0	38,0	23,0	with flanges	steel
PBD20H300	20	5	1615	87,0	80,85	79,48	62,0	-	84,0	38,0	23,0		
PBD21H300	21	5	1615	91,0	84,89	83,52	62,0	-	84,0	38,0	23,0		
PBD22H300	22	5	1615	94,0	88,94	87,57	62,0	-	84,0	38,0	23,0		
PBD23H300	23	5	1615	97,0	92,98	91,61	71,0	-	84,0	38,0	23,0		
PBD24H300	24	5	1615	102,0	97,02	95,65	71,0	-	84,0	38,0	23,0		
PBD25H300	25	5	1615	106,0	101,06	99,69	79,0	-	84,0	38,0	23,0		
PBD26H300	26	5	1615	112,0	105,11	103,74	79,0	-	84,0	38,0	23,0		
PBD27H300	27	5	2012	115,0	109,15	107,78	86,0	-	84,0	32,0	26,0		
PBD28H300	28	5	2012	120,0	113,19	111,92	86,0	-	84,0	32,0	26,0		
PBD30H300	30	5	2012	128,0	121,28	119,91	95,0	-	84,0	32,0	26,0		
PBD32H300	32	5	2517	135,0	129,36	127,99	110,0	-	84,0	45,0	19,5		
PBD33H300	33	5	2517	142,0	133,40	132,03	112,0	-	84,0	45,0	19,5		
PBD34H300	34	5	2517	142,0	137,45	136,08	112,0	-	84,0	45,0	19,5		
PBD36H300	36	5	2517	150,0	145,53	144,16	120,0	-	84,0	45,0	19,5		
PBD40H300	40	8	2517	168,0	161,70	160,33	136,0	120,0	84,0	45,0	19,5		
PBD44H300	44	8	2517	184,0	177,87	176,50	162,0	120,0	86,0	45,0	20,5		
PBD48H300	48	8	2517	200,0	194,04	192,67	168,0	120,0	86,0	45,0	20,5		
PBD60H300	60	8B	2517	-	242,55	241,18	223,0	120,0	86,0	45,0	20,5		
PBD72H300	72	8B	2517	-	291,06	289,69	264,0	120,0	86,0	45,0	20,5		
PBD84H300	84	8B	2517	-	339,57	338,20	312,0	120,0	86,0	45,0	20,5		
PBD94H300	94	8B	3030	-	380,00	378,63	357,0	146,0	86,0	76,0	5,0		
PBD96H300	96	8B	3030	-	388,08	386,71	357,0	146,0	86,0	76,0	5,0		
PBD106H300	106	8B	3030	-	428,51	427,14	402,0	146,0	86,0	76,0	5,0		
PBD116H300	116	8B	3030	-	468,93	467,56	442,0	146,0	86,0	76,0	5,0		
PBD118H300	118	8B	3030	-	477,02	475,65	457,0	146,0	86,0	76,0	5,0		
PBD120H300	120	8B	3030	-	485,10	483,73	457,0	146,0	86,0	76,0	5,0		

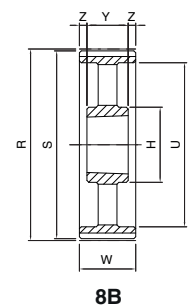
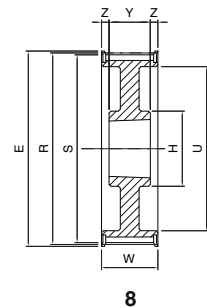
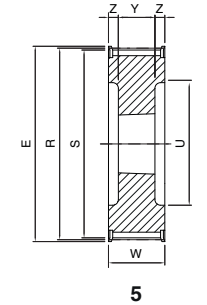

Dimensions of timing pulleys IMPERIAL PITCH - mounting taper bushing SER-SIT®



PBD ... XH200

XH

Code	Teeth nr.	Type	SER-SIT® Taper bushing	E [mm]	R [mm]	S [mm]	U [mm]	H [mm]	W [mm]	Y [mm]	Z [mm]	Flange	Material
PBD18XH200	18	4	2517	134,0	127,34	124,55	95,0	-	64,0	45,0	19,0	with flanges	cast iron
PBD20XH200	20	4	2517	150,0	141,49	138,70	101,0	-	64,0	45,0	19,0		
PBD21XH200	21	4	2517	158,0	148,56	145,77	115,0	-	64,0	45,0	19,0		
PBD22XH200	22	4	2517	166,0	155,64	152,85	115,0	-	64,0	45,0	19,0		
PBD24XH200	24	4	2517	177,0	169,79	167,00	129,0	-	64,0	45,0	19,0		
PBD26XH200	26	4	2517	191,0	183,94	181,15	143,0	-	64,0	45,0	19,0		
PBD28XH200	28	8	2517	209,0	198,08	195,29	157,0	120,0	64,0	45,0	9,5		
PBD30XH200	30	8	2517	216,0	212,23	209,44	180,0	120,0	64,0	45,0	9,5		
PBD32XH200	32	8	2517	232,0	226,38	223,59	195,0	120,0	64,0	45,0	9,5		
PBD38XH200	38	8	2517	274,0	268,83	266,03	234,0	120,0	64,0	45,0	9,5		
PBD40XH200	40	8	3020	288,0	282,98	280,19	242,0	146,0	64,0	51,0	6,5		
PBD46XH200	46	8B	3020	-	325,42	322,63	285,0	146,0	64,0	51,0	6,5		
PBD48XH200	48	8B	3020	-	339,57	336,78	299,0	146,0	64,0	51,0	6,5		
PBD58XH200	58	8B	3020	-	410,32	407,52	370,0	146,0	64,0	51,0	6,5		
PBD60XH200	60	11B	3535	-	424,47	421,68	384,0	178,0	64,0	89,0	12,5		
PBD70XH200	70	11B	3535	-	495,21	492,42	455,0	178,0	64,0	89,0	12,5		
PBD72XH200	72	11B	3535	-	509,36	506,57	469,0	178,0	64,0	89,0	12,5		
PBD78XH200	78	11B	3535	-	551,80	549,01	511,0	178,0	64,0	89,0	12,5		
PBD80XH200	80	11B	3535	-	565,95	563,16	525,0	178,0	64,0	89,0	12,5		
PBD82XH200	82	11B	3535	-	580,10	577,31	539,0	178,0	64,0	89,0	12,5		
PBD84XH200	84	11B	3535	-	594,25	591,46	554,0	178,0	64,0	89,0	12,5		

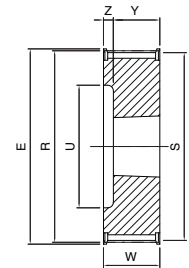

4

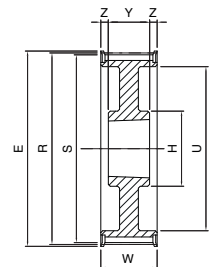

8

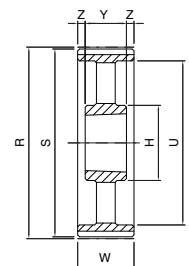

8B

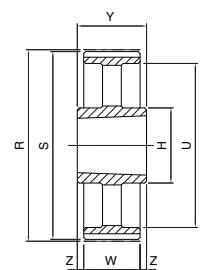

11B

Dimensions of timing pulleys IMPERIAL PITCH - mounting taper bushing SER-SIT®



PBD ... XH300

XH

Code	Teeth nr.	Type	SER-SIT® Taper bushing	E [mm]	R [mm]	S [mm]	U [mm]	H [mm]	W [mm]	Y [mm]	Z [mm]	Flange	Material
PBD18XH300	18	4	2517	134,0	127,34	124,55	95,0	-	90,0	45,0	45,0	with flanges	cast iron
PBD20XH300	20	4	2517	150,0	141,49	138,70	101,0	-	90,0	45,0	45,0		
PBD22XH300	22	4	2517	166,0	155,64	152,85	115,0	-	90,0	45,0	45,0		
PBD24XH300	24	4	2517	177,0	169,79	167,00	129,0	-	90,0	45,0	45,0		
PBD26XH300	26	4	2517	191,0	183,94	181,15	143,0	-	90,0	45,0	45,0		
PBD28XH300	28	10	3020	209,0	198,08	195,29	157,0	146,0	90,0	51,0	39,0		
PBD30XH300	30	10	3020	216,0	212,23	209,44	172,0	146,0	90,0	51,0	39,0		
PBD32XH300	32	10	3020	232,0	226,38	223,59	186,0	146,0	90,0	51,0	39,0		
PBD34XH300	34	10	3020	261,0	240,53	237,74	200,0	146,0	90,0	51,0	39,0		
PBD38XH300	38	10	3020	274,0	268,83	266,03	228,0	146,0	90,0	51,0	39,0		
PBD40XH300	40	8	3020	288,0	282,98	280,19	245,0	146,0	90,0	51,0	19,5		
PBD46XH300	46	8A	3020	-	325,42	322,63	285,0	146,0	90,0	51,0	19,5		
PBD48XH300	48	8A	3020	-	339,57	336,78	299,0	146,0	90,0	51,0	19,5		
PBD58XH300	58	8A	3535	-	410,32	407,52	370,0	178,0	90,0	89,0	0,5		
PBD60XH300	60	8A	3535	-	424,47	421,68	384,0	178,0	90,0	89,0	0,5		
PBD70XH300	70	8B	3535	-	495,21	492,42	455,0	178,0	90,0	89,0	0,5		
PBD72XH300	72	8B	3535	-	509,36	506,57	469,0	178,0	90,0	89,0	0,5		
PBD78XH300	78	8B	3535	-	551,80	549,01	511,0	178,0	90,0	89,0	0,5		
PBD80XH300	80	8B	3535	-	565,95	563,16	525,0	178,0	90,0	89,0	0,5		
PBD82XH300	82	8B	3535	-	580,10	577,31	539,0	178,0	90,0	89,0	0,5		
PBD84XH300	84	11B	4040	-	594,25	591,46	554,0	215,0	90,0	102,0	6,0		

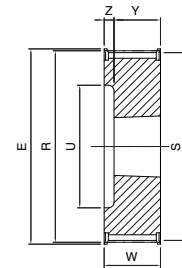

4

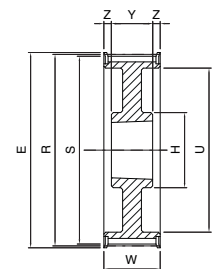

8

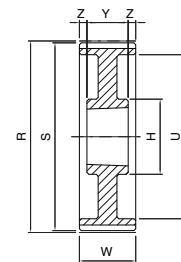

8A

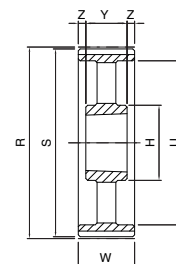

8B

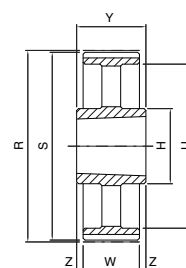

11B

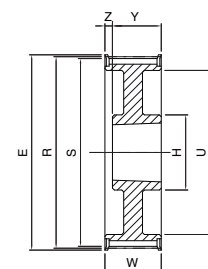

10

Dimensions of timing pulleys IMPERIAL PITCH - mounting taper bushing SER-SIT®



PBD ... XH400

XH

Code	Teeth nr.	Type	SER-SIT® Taper bushing	E [mm]	R [mm]	S [mm]	U [mm]	H [mm]	W [mm]	Y [mm]	Z [mm]	Flange	Material
PBD18XH400	18	4	2517	134,0	127,34	124,55	95,0	-	119,0	45,0	74,0	with flanges	cast iron
PBD20XH400	20	4	2517	150,0	141,49	138,70	101,0	-	119,0	45,0	74,0		
PBD21XH400	21	4	2517	158,0	148,56	145,77	115,0	-	119,0	45,0	74,0		
PBD22XH400	22	4	2517	166,0	155,64	152,85	115,0	-	119,0	45,0	74,0		
PBD24XH400	24	4	3020	177,0	169,79	167,00	129,0	-	119,0	51,0	68,0		
PBD26XH400	26	4	3020	191,0	183,94	181,15	143,0	-	119,0	51,0	68,0		
PBD28XH400	28	4	3020	209,0	198,08	195,29	157,0	-	119,0	51,0	68,0		
PBD30XH400	30	10	3020	216,0	212,23	209,44	172,0	146,0	119,0	51,0	68,0		
PBD32XH400	32	10	3020	232,0	226,38	223,59	186,0	146,0	119,0	51,0	68,0		
PBD34XH400	34	10	3020	261,0	240,53	237,74	200,0	146,0	119,0	51,0	68,0		
PBD38XH400	38	10	3020	274,0	268,83	266,03	228,0	146,0	119,0	51,0	68,0		
PBD40XH400	40	8	3535	288,0	282,98	280,19	242,0	178,0	119,0	89,0	15,0	without flanges	
PBD46XH400	46	8A	3535	-	325,42	322,63	285,0	178,0	119,0	89,0	15,0		
PBD48XH400	48	8A	3535	-	339,57	336,78	299,0	178,0	119,0	89,0	15,0		
PBD58XH400	58	8B	3535	-	410,32	407,52	370,0	178,0	119,0	89,0	15,0		
PBD60XH400	60	8B	4040	-	424,47	421,68	384,0	215,0	119,0	102,0	8,5		
PBD70XH400	70	8B	4040	-	495,21	492,42	455,0	215,0	119,0	102,0	8,5		
PBD72XH400	72	8B	4040	-	509,36	506,57	469,0	215,0	119,0	102,0	8,5		
PBD78XH400	78	8B	4040	-	551,80	549,01	511,0	215,0	119,0	102,0	8,5		
PBD80XH400	80	8B	4040	-	565,95	563,16	525,0	215,0	119,0	102,0	8,5		
PBD82XH400	82	8B	4040	-	580,10	577,31	539,0	215,0	119,0	102,0	8,5		
PBD84XH400	84	8B	4040	-	594,25	591,46	554,0	215,0	119,0	102,0	8,5		

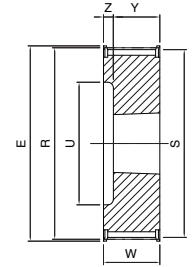

4

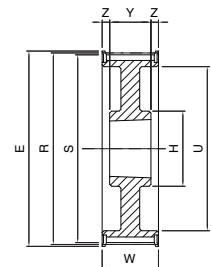

8

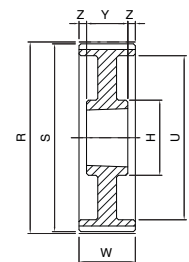

8A

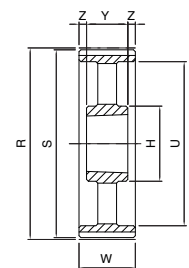

8B

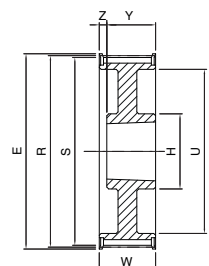

10

SIT timing pulleys - METRIC PITCH

Standard timing pulleys METRIC PITCH are made in aluminum, in solid hub execution.

Solid hub

Material: aluminum

Pitch:

- T 2,5
- T 5
- T 10

- AT5
- AT 10



Solid hub

Material: on request

Pitch:

- T20
- AT 20



Special executions

Upon request, SIT is able to design and manufacture any type of pulley based on customer requirements.

For standard executions the teeth shape and the consequent backlash are related to the number of teeth.

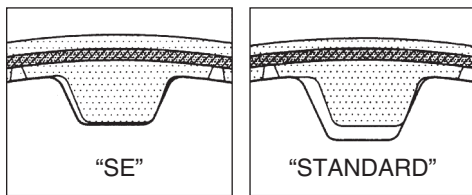

Z < 20

Z > 20

SE: reduced backlash

On demand, in case of very precise applications (e.g. positioning systems), a "zero backlash" version can be supplied.

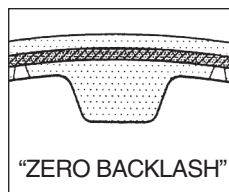

On demand

TOLERANCES

Pulley diameter tolerances

External diameter [mm]	Tolerances [mm]
up to 25,4	-0,05 +0,00
from 25,5 to 50,8	-0,08 +0,00
from 50,9 to 102	-0,10 +0,00
from 103 to 178	-0,13 +0,00
from 179 to 305	-0,15 +0,00
from 306 to 509	-0,18 +0,00
from 510 to 761	-0,20 +0,00
from 762 to 1015	-0,23 +0,00
more than 1016	-0,25 +0,00

Radial circular runout

External diameter [mm]	Measured total eccentricity [mm]
up to 203,2	0,13
more than 203,2	add 0,013 for any 25,4 of diameter

Cylindricity tolerance

Pulley width	Tolerances
for any 100 mm	0,1 mm without exceeding the external diameter tolerance

Flanged pulleys

Timing belts, when in motion, have a slight lateral displacement. It is therefore necessary to use at least one flanged pulley to prevent the belt jumping out of the pulley.

Usually, in order to reduce the costs, the flanged pulley is the one with the smaller diameter.

In any case, when the distance of the axes is greater than 8 times the diameter of the small pulley, or when the transmission is working on shafts arranged in a position that is not horizontal, both pulleys have to be flanged.

Protective coating

Lifetime of aluminum pulleys can be reduced because the nylon coating of the belt teeth has a slightly abrasive effect.

This disadvantage can be reduced applying a high thickness anodization coating on the pulley teeth.

Note

Due to a constant improvement of our products, technical data of the pulleys may be subject to changes.

For technical and production reasons, in some cases materials other than those indicated in the catalogue may be used.

For confirmation of the material actually available, please contact customer service.

Dimensions of timing pulleys METRIC PITCH "T" - solid hub

Pitches T 2,5 - T 5 - T 10 - T 20



Part Number	PDMT 27 T2,5 /24
METRIC PITCH timing pulley "T"	
Total width (mm)	
Pitch	
Number of teeth	

T 2,5

Code	Teeth nr.	Type	E [mm]	R [mm]	S [mm]	H [mm]	W [mm]	Y [mm]	Z [mm]	Material
PDMT 16 T2,5/12	12	2	13,0	9,55	9,05	13,0	9,0	16,0	7,0	aluminum
PDMT 16 T2,5/14	14	2	15,0	11,14	10,64	15,0	9,0	16,0	7,0	
PDMT 16 T2,5/15	15	2	15,0	11,94	11,44	15,0	9,0	16,0	7,0	
PDMT 16 T2,5/16	16	2	16,0	12,73	12,23	16,0	10,0	16,0	6,0	
PDMT 16 T2,5/18	18	1	17,5	14,32	13,82	10,0	10,0	16,0	6,0	
PDMT 16 T2,5/19	19	1	20,0	15,12	14,62	10,0	10,0	16,0	6,0	
PDMT 16 T2,5/20	20	1	20,0	15,92	15,41	11,0	10,0	16,0	6,0	
PDMT 16 T2,5/22	22	1	22,0	17,51	17,01	11,0	10,0	16,0	6,0	
PDMT 16 T2,5/24	24	1	22,0	19,10	18,60	12,0	10,0	16,0	6,0	
PDMT 16 T2,5/25	25	1	23,0	19,89	19,39	13,0	10,0	16,0	6,0	
PDMT 16 T2,5/26	26	1	26,0	20,69	20,19	14,0	10,0	16,0	6,0	
PDMT 16 T2,5/28	28	1	26,0	22,28	21,78	14,0	10,0	16,0	6,0	
PDMT 16 T2,5/30	30	1	28,0	23,87	23,37	16,0	10,0	16,0	6,0	
PDMT 16 T2,5/32	32	1	32,0	25,46	24,96	16,0	10,0	16,0	6,0	
PDMT 16 T2,5/36	36	1	36,0	28,65	28,15	20,0	10,0	16,0	6,0	
PDMT 16 T2,5/40	40	1	38,0	31,83	31,33	22,0	10,0	16,0	6,0	
PDMT 16 T2,5/44	44	1	42,0	35,01	34,51	24,0	10,0	16,0	6,0	
PDMT 16 T2,5/48	48	1A	-	38,20	37,70	26,0	10,0	16,0	6,0	
PDMT 16 T2,5/60	60	1A	-	47,75	47,25	34,0	10,0	16,0	6,0	

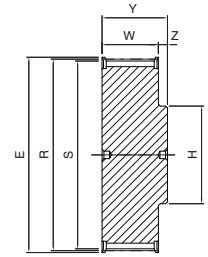

1

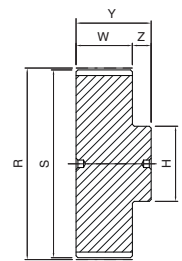

1A

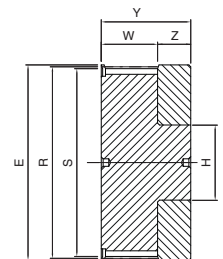

2

T 5

Code	Teeth nr.	Type	E [mm]	R [mm]	S [mm]	H [mm]	Belt width						Z [mm]	Material
							10 mm		16 mm		25 mm			
							W [mm]	Y [mm]	W [mm]	Y [mm]	W [mm]	Y [mm]		
PDMT quoteY T5/10	10	1	19,50	15,92	15,07	8,0	15,0	21,0	21,0	27,0	30,0	36,0	6,0	aluminum
PDMT quoteY T5/12	12	1	23,00	19,10	18,26	11,0	15,0	21,0	21,0	27,0	30,0	36,0	6,0	
PDMT quoteY T5/14	14	1	25,00	22,28	21,44	13,0	15,0	21,0	21,0	27,0	30,0	36,0	6,0	
PDMT quoteY T5/15	15	1	28,00	23,87	23,03	16,0	15,0	21,0	21,0	27,0	30,0	36,0	6,0	
PDMT quoteY T5/16	16	1	32,00	25,46	24,62	18,0	15,0	21,0	21,0	27,0	30,0	36,0	6,0	
PDMT quoteY T5/18	18	1	32,00	28,65	27,81	20,0	15,0	21,0	21,0	27,0	30,0	36,0	6,0	
PDMT quoteY T5/19	19	1	36,00	30,24	29,40	20,0	15,0	21,0	21,0	27,0	30,0	36,0	6,0	
PDMT quoteY T5/20	20	1	36,00	31,83	30,99	22,0	15,0	21,0	21,0	27,0	30,0	36,0	6,0	
PDMT quoteY T5/22	22	1	38,00	35,01	34,17	23,0	15,0	21,0	21,0	27,0	30,0	36,0	6,0	
PDMT quoteY T5/24	24	1	42,00	38,20	37,36	24,0	15,0	21,0	21,0	27,0	30,0	36,0	6,0	
PDMT quoteY T5/25	25	1	44,00	39,79	38,95	26,0	15,0	21,0	21,0	27,0	30,0	36,0	6,0	
PDMT quoteY T5/26	26	1	44,00	41,38	40,54	26,0	15,0	21,0	21,0	27,0	30,0	36,0	6,0	
PDMT quoteY T5/27	27	1	48,00	42,97	42,13	30,0	15,0	21,0	21,0	27,0	30,0	36,0	6,0	
PDMT quoteY T5/28	28	1	48,00	44,56	43,72	32,0	15,0	21,0	21,0	27,0	30,0	36,0	6,0	
PDMT quoteY T5/30	30	1	51,00	47,75	46,91	34,0	15,0	21,0	21,0	27,0	30,0	36,0	6,0	
PDMT quoteY T5/32	32	1	54,00	50,93	50,09	38,0	15,0	21,0	21,0	27,0	30,0	36,0	6,0	
PDMT quoteY T5/36	36	1	64,00	57,30	56,46	38,0	15,0	21,0	21,0	27,0	30,0	36,0	6,0	
PDMT quoteY T5/40	40	1	66,50	63,66	62,82	40,0	15,0	21,0	21,0	27,0	30,0	36,0	6,0	
PDMT quoteY T5/42	42	1	70,00	66,85	66,00	40,0	15,0	21,0	21,0	27,0	30,0	36,0	6,0	
PDMT quoteY T5/44	44	1A	-	70,03	69,19	45,0	15,0	21,0	21,0	27,0	30,0	36,0	6,0	
PDMT quoteY T5/48	48	1A	-	76,39	75,55	50,0	15,0	21,0	21,0	27,0	30,0	36,0	6,0	
PDMT quoteY T5/60	60	1A	-	95,49	94,65	65,0	15,0	21,0	21,0	27,0	30,0	36,0	6,0	

Dimensions of timing pulleys METRIC PITCH “T” - solid hub



T 10

Code	Teeth nr.	Type	E [mm]	R [mm]	S [mm]	U [mm]	H [mm]	Belt width								Z [mm]	Material
								16 mm		25 mm		32 mm		50 mm			
								W [mm]	Y [mm]	W [mm]	Y [mm]	W [mm]	Y [mm]	W [mm]	Y [mm]		
PDMT quoteY T10/12	12	1	42,0	38,20	36,34	-	28,0	21,0	31,0	30,0	40,0	-	-	-	-	10,0	aluminum
PDMT quoteY T10/14	14	1	48,0	44,56	42,70	-	32,0	21,0	31,0	30,0	40,0	-	-	-	-	10,0	
PDMT quoteY T10/15	15	1	51,0	47,75	45,89	-	32,0	21,0	31,0	30,0	40,0	-	-	-	-	10,0	
PDMT quoteY T10/16	16	1	54,0	50,93	49,07	-	35,0	21,0	31,0	30,0	40,0	-	-	-	-	10,0	
PDMT quoteY T10/18	18	1	60,0	57,30	55,44	-	40,0	21,0	31,0	30,0	40,0	37,0	47,0	56,0	66,0	10,0	
PDMT quoteY T10/19	19	1	66,0	60,48	58,62	-	44,0	21,0	31,0	30,0	40,0	37,0	47,0	56,0	66,0	10,0	
PDMT quoteY T10/20	20	1	66,0	63,66	61,80	-	46,0	21,0	31,0	30,0	40,0	37,0	47,0	56,0	66,0	10,0	
PDMT quoteY T10/22	22	1	75,0	70,03	68,17	-	52,0	21,0	31,0	30,0	40,0	37,0	47,0	56,0	66,0	10,0	
PDMT quoteY T10/24	24	1	83,0	76,39	74,53	-	58,0	21,0	31,0	30,0	40,0	37,0	47,0	56,0	66,0	10,0	
PDMT quoteY T10/25	25	1	83,0	79,58	77,72	-	60,0	21,0	31,0	30,0	40,0	37,0	47,0	56,0	66,0	10,0	
PDMT quoteY T10/26	26	1	87,0	82,76	80,90	-	60,0	21,0	31,0	30,0	40,0	37,0	47,0	56,0	66,0	10,0	
PDMT quoteY T10/27	27	1	91,0	85,94	84,08	-	60,0	21,0	31,0	30,0	40,0	37,0	47,0	56,0	66,0	10,0	
PDMT quoteY T10/28	28	1	93,0	89,13	87,27	-	60,0	21,0	31,0	30,0	40,0	37,0	47,0	56,0	66,0	10,0	
PDMT quoteY T10/30	30	1	97,0	95,49	93,63	-	60,0	21,0	31,0	30,0	40,0	37,0	47,0	56,0	66,0	10,0	
PDMT quoteY T10/32	32	1	106,0	101,86	100,00	-	65,0	21,0	31,0	30,0	40,0	37,0	47,0	56,0	66,0	10,0	
PDMT quoteY T10/36	36	1	119,0	114,59	112,73	-	70,0	21,0	31,0	30,0	40,0	37,0	47,0	56,0	66,0	10,0	
PDMT quoteY T10/40	40	1	131,0	127,32	125,46	-	80,0	21,0	31,0	30,0	40,0	37,0	47,0	56,0	66,0	10,0	
PDMT quoteY T10/44	44	3A	-	140,06	138,20	118,0	88,0	21,0	31,0	30,0	40,0	37,0	47,0	56,0	66,0	10,0	
PDMT quoteY T10/48	48	3A	-	152,79	150,93	130,0	95,0	21,0	31,0	30,0	40,0	37,0	47,0	56,0	66,0	10,0	
PDMT quoteY T10/60	60	3A	-	190,99	189,13	165,0	110,0	21,0	31,0	30,0	40,0	37,0	47,0	56,0	66,0	10,0	

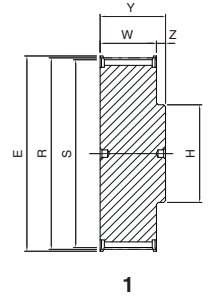

1

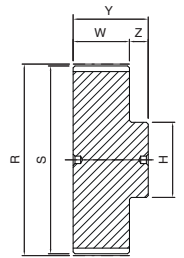

1A

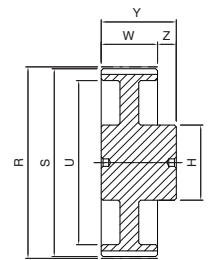

3A

T 20

Code	Teeth nr.	Type	E [mm]	R [mm]	S [mm]	U [mm]	H [mm]	d Ø	Belt width									Material
									32 mm			50 mm			100 mm			
									W [mm]	Y [mm]	Z [mm]	W [mm]	Y [mm]	Z [mm]	W [mm]	Y [mm]	Z [mm]	
PDMT quoteY T20/18	18	1	118,0	114,59	111,74	-	80,0	-	42,0	53,0	11,0	60,0	71,0	11,0	110,0	123,0	13,0	on request
PDMT quoteY T20/20	20	1	134,0	127,32	124,47	-	90,0	-	42,0	53,0	11,0	60,0	71,0	11,0	110,0	123,0	13,0	
PDMT quoteY T20/22	22	1	150,0	140,06	137,21	-	90,0	-	42,0	53,0	11,0	60,0	71,0	11,0	110,0	123,0	13,0	
PDMT quoteY T20/24	24	1	158,0	152,79	149,94	-	95,0	-	42,0	53,0	11,0	60,0	71,0	11,0	110,0	123,0	13,0	
PDMT quoteY T20/25	25	1	166,0	159,15	156,30	-	95,0	-	42,0	53,0	11,0	60,0	71,0	11,0	110,0	123,0	13,0	
PDMT quoteY T20/30	30	1	200,0	190,99	188,14	-	110,0	-	42,0	53,0	11,0	60,0	71,0	11,0	110,0	123,0	13,0	
PDMT quoteY T20/32	32	1A	-	203,72	200,87	-	110,0	-	42,0	53,0	11,0	60,0	71,0	11,0	110,0	123,0	13,0	
PDMT quoteY T20/36	36	1A	-	229,18	226,33	-	110,0	-	42,0	53,0	11,0	60,0	71,0	11,0	110,0	123,0	13,0	
PDMT quoteY T20/40	40	3A	-	254,65	251,80	210,0	110,0	-	42,0	53,0	11,0	60,0	71,0	11,0	110,0	123,0	13,0	
PDMT quoteY T20/48	48	3A	-	305,58	302,73	260,0	130,0	-	42,0	53,0	11,0	60,0	71,0	11,0	110,0	123,0	13,0	
PDMT quoteY T20/60	60	3A	-	381,97	379,12	338,0	130,0	22,0	42,0	53,0	11,0	60,0	71,0	11,0	110,0	123,0	13,0	
PDMT quoteY T20/72	72	3A	-	458,37	455,52	415,0	140,0	22,0	42,0	53,0	11,0	60,0	71,0	11,0	110,0	123,0	13,0	

Dimensions of timing pulleys METRIC PITCH “AT” - solid hub

Pitches AT 5 - AT 10 - AT 20

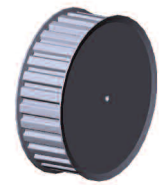

Part Number	PMAT 36 AT5 /20
METRIC PITCH timing pulley “AT”	
Total width (mm)	
Pitch	
Number of teeth	

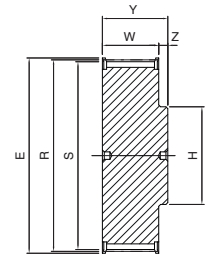

1

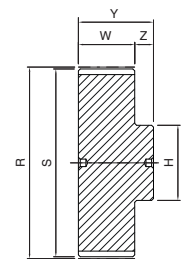

1A

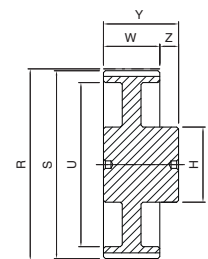

3A

AT 5

Code	Teeth nr.	Type	E [mm]	R [mm]	S [mm]	H [mm]	Belt width						Z [mm]	Material
							10 mm		16 mm		25 mm			
							W [mm]	Y [mm]	W [mm]	Y [mm]	W [mm]	Y [mm]		
PMAT quoteY AT5/12	12	1	23,0	19,10	17,88	11,0	15,0	21,0	21,0	27,0	30,0	36,0	6,0	aluminum
PMAT quoteY AT5/14	14	1	25,0	22,28	21,06	14,0	15,0	21,0	21,0	27,0	30,0	36,0	6,0	
PMAT quoteY AT5/15	15	1	28,0	23,87	22,65	16,0	15,0	21,0	21,0	27,0	30,0	36,0	6,0	
PMAT quoteY AT5/16	16	1	32,0	25,46	24,24	18,0	15,0	21,0	21,0	27,0	30,0	36,0	6,0	
PMAT quoteY AT5/18	18	1	32,0	28,65	27,43	20,0	15,0	21,0	21,0	27,0	30,0	36,0	6,0	
PMAT quoteY AT5/19	19	1	36,0	30,24	29,02	22,0	15,0	21,0	21,0	27,0	30,0	36,0	6,0	
PMAT quoteY AT5/20	20	1	36,0	31,83	30,61	23,0	15,0	21,0	21,0	27,0	30,0	36,0	6,0	
PMAT quoteY AT5/22	22	1	38,0	35,01	33,79	24,0	15,0	21,0	21,0	27,0	30,0	36,0	6,0	
PMAT quoteY AT5/24	24	1	42,0	38,20	36,98	26,0	15,0	21,0	21,0	27,0	30,0	36,0	6,0	
PMAT quoteY AT5/25	25	1	44,0	39,79	38,57	26,0	15,0	21,0	21,0	27,0	30,0	36,0	6,0	
PMAT quoteY AT5/26	26	1	44,0	41,38	40,16	26,0	15,0	21,0	21,0	27,0	30,0	36,0	6,0	
PMAT quoteY AT5/27	27	1	48,0	42,97	41,75	30,0	15,0	21,0	21,0	27,0	30,0	36,0	6,0	
PMAT quoteY AT5/28	28	1	48,0	44,56	43,34	32,0	15,0	21,0	21,0	27,0	30,0	36,0	6,0	
PMAT quoteY AT5/30	30	1	51,0	47,75	46,53	34,0	15,0	21,0	21,0	27,0	30,0	36,0	6,0	
PMAT quoteY AT5/32	32	1	54,0	50,93	49,71	36,0	15,0	21,0	21,0	27,0	30,0	36,0	6,0	
PMAT quoteY AT5/36	36	1	64,0	57,30	56,08	38,0	15,0	21,0	21,0	27,0	30,0	36,0	6,0	
PMAT quoteY AT5/40	40	1	67,0	63,66	62,44	40,0	15,0	21,0	21,0	27,0	30,0	36,0	6,0	
PMAT quoteY AT5/42	42	1	70,0	66,85	65,62	40,0	15,0	21,0	21,0	27,0	30,0	36,0	6,0	
PMAT quoteY AT5/44	44	1A	-	70,03	68,81	45,0	15,0	21,0	21,0	27,0	30,0	36,0	6,0	
PMAT quoteY AT5/48	48	1A	-	76,39	75,17	50,0	15,0	21,0	21,0	27,0	30,0	36,0	6,0	
PMAT quoteY AT5/60	60	1A	-	95,49	94,27	65,0	15,0	21,0	21,0	27,0	30,0	36,0	6,0	

AT 10

Code	Teeth nr.	Type	E [mm]	R [mm]	S [mm]	U [mm]	H [mm]	Belt width								Z [mm]	Material
								16 mm		25 mm		32 mm		50 mm			
								W [mm]	Y [mm]	W [mm]	Y [mm]	W [mm]	Y [mm]	W [mm]	Y [mm]		
PMAT quoteY AT10/15	15	1	51,0	47,75	45,93	-	31,0	21,0	31,0	30,0	40,0	-	-	-	-	10,0	aluminum
PMAT quoteY AT10/16	16	1	54,0	50,93	49,11	-	35,0	21,0	31,0	30,0	40,0	-	-	-	-	10,0	
PMAT quoteY AT10/18	18	1	60,0	57,3	55,48	-	40,0	21,0	31,0	30,0	40,0	37,0	47,0	56,0	66,0	10,0	
PMAT quoteY AT10/19	19	1	66,0	60,48	58,66	-	44,0	21,0	31,0	30,0	40,0	37,0	47,0	56,0	66,0	10,0	
PMAT quoteY AT10/20	20	1	66,0	63,66	61,84	-	46,0	21,0	31,0	30,0	40,0	37,0	47,0	56,0	66,0	10,0	
PMAT quoteY AT10/22	22	1	75,0	70,03	68,21	-	52,0	21,0	31,0	30,0	40,0	37,0	47,0	56,0	66,0	10,0	
PMAT quoteY AT10/24	24	1	83,0	76,39	74,57	-	58,0	21,0	31,0	30,0	40,0	37,0	47,0	56,0	66,0	10,0	
PMAT quoteY AT10/25	25	1	83,0	79,58	77,76	-	60,0	21,0	31,0	30,0	40,0	37,0	47,0	56,0	66,0	10,0	
PMAT quoteY AT10/26	26	1	87,0	82,76	80,94	-	60,0	21,0	31,0	30,0	40,0	37,0	47,0	56,0	66,0	10,0	
PMAT quoteY AT10/27	27	1	91,0	85,94	84,12	-	60,0	21,0	31,0	30,0	40,0	37,0	47,0	56,0	66,0	10,0	
PMAT quoteY AT10/28	28	1	93,0	89,13	87,31	-	60,0	21,0	31,0	30,0	40,0	37,0	47,0	56,0	66,0	10,0	
PMAT quoteY AT10/30	30	1	97,0	95,49	93,67	-	60,0	21,0	31,0	30,0	40,0	37,0	47,0	56,0	66,0	10,0	
PMAT quoteY AT10/32	32	1	106,0	101,86	100,04	-	65,0	21,0	31,0	30,0	40,0	37,0	47,0	56,0	66,0	10,0	
PMAT quoteY AT10/36	36	1	119,0	114,59	112,77	-	70,0	21,0	31,0	30,0	40,0	37,0	47,0	56,0	66,0	10,0	
PMAT quoteY AT10/40	40	1	131,0	127,32	125,50	-	80,0	21,0	31,0	30,0	40,0	37,0	47,0	56,0	66,0	10,0	
PMAT quoteY AT10/44	44	3A	-	140,06	138,24	118,0	88,0	21,0	31,0	30,0	40,0	37,0	47,0	56,0	66,0	10,0	
PMAT quoteY AT10/48	48	3A	-	152,79	150,97	130,0	95,0	21,0	31,0	30,0	40,0	37,0	47,0	56,0	66,0	10,0	
PMAT quoteY AT10/60	60	3A	-	190,99	189,17	165,0	110,0	21,0	31,0	30,0	40,0	37,0	47,0	56,0	66,0	10,0	

Dimensions of timing pulleys METRIC PITCH “AT” - solid hub

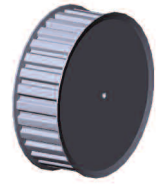

AT 20

Code	Teeth nr.	Type	E [mm]	R [mm]	S [mm]	U [mm]	H [mm]	d Ø	Belt width									Material
									32 mm			50 mm			100 mm			
									W [mm]	Y [mm]	Z [mm]	W [mm]	Y [mm]	Z [mm]	W [mm]	Y [mm]	Z [mm]	
PMAT quoteY AT20/18	18	1	118,0	114,59	111,77	-	80,0	-	42,0	53,0	11,0	60,0	71,0	11,0	110,0	123,0	13,0	on request
PMAT quoteY AT20/20	20	1	134,0	127,32	124,50	-	90,0	-	42,0	53,0	11,0	60,0	71,0	11,0	110,0	123,0	13,0	
PMAT quoteY AT20/22	22	1	150,0	140,06	137,24	-	90,0	-	42,0	53,0	11,0	60,0	71,0	11,0	110,0	123,0	13,0	
PMAT quoteY AT20/24	24	1	158,0	152,79	149,97	-	95,0	-	42,0	53,0	11,0	60,0	71,0	11,0	110,0	123,0	13,0	
PMAT quoteY AT20/25	25	1	166,0	159,15	156,33	-	95,0	-	42,0	53,0	11,0	60,0	71,0	11,0	110,0	123,0	13,0	
PMAT quoteY AT20/30	30	1	200,0	190,99	188,17	-	110,0	-	42,0	53,0	11,0	60,0	71,0	11,0	110,0	123,0	13,0	
PMAT quoteY AT20/32	32	1A	-	203,72	200,90	-	110,0	-	42,0	53,0	11,0	60,0	71,0	11,0	110,0	123,0	13,0	
PMAT quoteY AT20/36	36	1A	-	229,18	226,36	-	110,0	-	42,0	53,0	11,0	60,0	71,0	11,0	110,0	123,0	13,0	
PMAT quoteY AT20/40	40	3A	-	254,65	251,83	210,0	110,0	-	42,0	53,0	11,0	60,0	71,0	11,0	110,0	123,0	13,0	
PMAT quoteY AT20/48	48	3A	-	305,58	302,76	260,0	130,0	-	42,0	53,0	11,0	60,0	71,0	11,0	110,0	123,0	13,0	
PMAT quoteY AT20/60	60	3A	-	381,97	379,15	338,0	130,0	22,0	42,0	53,0	11,0	60,0	71,0	11,0	110,0	123,0	13,0	
PMAT quoteY AT20/72	72	3A	-	458,37	455,55	415,0	140,0	22,0	42,0	53,0	11,0	60,0	71,0	11,0	110,0	123,0	13,0	

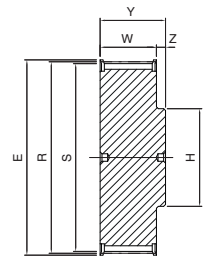

1

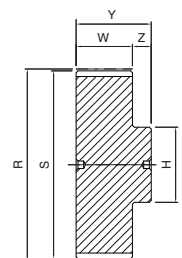

1A

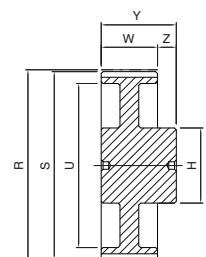

3A

SIT timing pulleys - TOP DRIVE® HTD

TOP DRIVE® HTD pulleys have a different design from the traditional toothed pulleys.

The axial grooves are designed to allow the belt teeth to catch the pulley teeth with negligible friction.

TOP DRIVE® HTD pulleys are available with full hub and for assembly with SER-SIT® taper bushing.

Solid hub

Material: aluminum/cast iron/steel.

Finishing: protective surface treatment.

Pitch:

- 3M
- 5M
- 8M
- 14M



For mounting taper bushing SER-SIT®

Material: cast iron/steel.

Finishing: protective surface treatment.

Pitch:

- 5M
- 8M
- 14M



Special executions

Upon request, SIT is able to design and manufacture any type of pulley based on customer requirements.

For peripheral speed exceeding 33 m/s it is strongly recommended to use steel as material of construction.

$$\text{peripheral speed [m/s]} = \frac{\text{pulley diameter [mm]} \cdot \text{rpm}}{19100}$$

In order to reduce the system weight, the pulleys can be manufactured from light metals; in this case the lifetime will be reduced when compared to the standard because the nylon belt coating has a slightly abrasive effect. This disadvantage can be reduced with a high thickness anodization coating of the teeth.

Flanged pulleys

Timing belts, when in motion, have a slight lateral displacement. It is therefore necessary to use at least one flanged pulley to prevent the belt jumping out of the pulley.

Usually, in order to reduce the costs, the flanged pulley is the one with the smaller diameter.

In any case, when the distance of the axes is greater than 8 times the diameter of the small pulley, or when the transmission is working on shafts arranged in a position that is not horizontal one, both pulleys have to be flanged.

TOLERANCES

Pulley diameter tolerances

External Diameter [mm]	Tolerances [mm]
up to 25,4	-0,00 +0,05
from 25,5 to 50,8	-0,00 +0,08
from 50,9 to 101,6	-0,00 +0,10
from 101,7 to 177,8	-0,00 +0,13
from 177,9 to 304,8	-0,00 +0,15
from 304,9 to 508,0	-0,00 +0,18
more than 508,1	-0,00 +0,25

Radial circular runout

External Diameter [mm]	Measured total eccentricity [mm]
up to 200	0,13
more than 200	add 0,0005 for any mm more than 200

Cylindricity tolerance

Pulley width	Tolerances
for any 100 mm	0,1 mm without exceeding the external diameter tolerance

Protective coating

All (steel and cast iron) pulleys are treated with surface process that gives greater resistance against oxidizing agents. This treatment does not modify the profile or the dimensions of the pulleys.

On request SIT can provide a wide range of special coating, related to the customer specific needs or environmental critical conditions.

Note

Due to a constant improvement of our products, technical data of the pulleys may be subject to changes. For technical and production reasons, in some cases materials other than those indicated in the catalogue may be used. For confirmation of the material actually available, please contact customer service.

Dimensions of timing pulleys TOP DRIVE® HTD - solid hub pitches 3M - 5M - 8M - 14M



Part Number HD 48 -8M 20

HTD timing pulleys - solid hub

Number of teeth

Pitch

Belt width in mm

HD ... -3M09

3M

Code	Teeth nr.	Type	E [mm]	R [mm]	S [mm]	H [mm]	W [mm]	Y [mm]	Z [mm]	Flange	Material
HD 10 - 3M 09	10	2	13,0	9,55	8,79	13,0	10,2	17,5	7,3	with flanges	aluminum
HD 12 - 3M 09	12	2	15,0	11,46	10,70	15,0	10,2	17,5	7,3		
HD 14 - 3M 09	14	2	16,0	13,37	12,61	18,0	10,2	17,5	7,3		
HD 15 - 3M 09	15	2	17,5	14,32	13,56	18,0	10,2	17,5	7,3		
HD 16 - 3M 09	16	1	17,5	15,28	14,52	10,0	12,8	20,6	7,8		
HD 18 - 3M 09	18	1	20,0	17,19	16,43	10,0	12,8	20,6	7,8		
HD 20 - 3M 09	20	1	23,0	19,10	18,34	13,0	12,8	20,6	7,8		
HD 21 - 3M 09	21	1	25,0	20,05	19,29	13,0	12,8	20,6	7,8		
HD 22 - 3M 09	22	1	25,0	21,01	20,25	13,0	12,8	20,6	7,8		
HD 24 - 3M 09	24	1	25,0	22,92	22,16	14,0	12,8	20,6	7,8		
HD 26 - 3M 09	26	1	28,0	24,83	24,07	16,0	12,8	20,6	7,8		
HD 28 - 3M 09	28	1	32,0	26,74	25,98	18,0	12,8	20,6	7,8		
HD 30 - 3M 09	30	1	32,0	28,65	27,89	20,0	12,8	20,6	7,8		
HD 32 - 3M 09	32	1	36,0	30,56	29,80	22,0	12,8	20,6	7,8		
HD 36 - 3M 09	36	1	39,0	34,38	33,62	26,0	13,4	22,2	8,8		
HD 40 - 3M 09	40	1	42,0	38,20	37,44	28,0	13,4	22,2	8,8		
HD 44 - 3M 09	44	1	48,0	42,02	41,26	33,0	13,4	22,2	8,8		
HD 48 - 3M 09	48	1A	-	45,84	45,08	33,0	13,4	22,2	8,8		
HD 60 - 3M 09	60	1A	-	57,30	56,54	33,0	13,4	22,2	8,8		
HD 72 - 3M 09	72	1A	-	68,75	67,99	33,0	13,4	22,2	8,8		

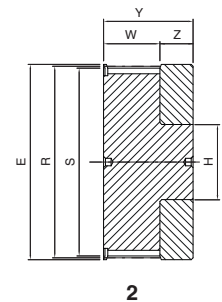
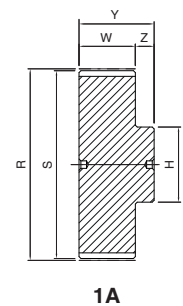
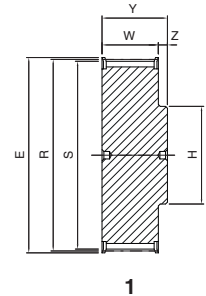

HD ... -3M15

3M

Code	Teeth nr.	Type	E [mm]	R [mm]	S [mm]	H [mm]	W [mm]	Y [mm]	Z [mm]	Flange	Material
HD 10 - 3M 15	10	2	13,0	9,55	8,79	13,0	17,0	26,0	9,0	with flanges	aluminum
HD 12 - 3M 15	12	2	15,0	11,46	10,70	15,0	17,0	26,0	9,0		
HD 14 - 3M 15	14	2	16,0	13,37	12,61	18,0	17,0	26,0	9,0		
HD 15 - 3M 15	15	2	17,5	14,32	13,56	18,0	17,0	26,0	9,0		
HD 16 - 3M 15	16	1	17,5	15,28	14,52	10,0	19,5	26,0	6,5		
HD 18 - 3M 15	18	1	20,0	17,19	16,43	10,0	19,5	26,0	6,5		
HD 20 - 3M 15	20	1	23,0	19,10	18,34	13,0	19,5	26,0	6,5		
HD 21 - 3M 15	21	1	25,0	20,05	19,29	13,0	19,5	26,0	6,5		
HD 22 - 3M 15	22	1	25,0	21,01	20,25	13,0	19,5	26,0	6,5		
HD 24 - 3M 15	24	1	25,0	22,92	22,16	14,0	19,5	26,0	6,5		
HD 26 - 3M 15	26	1	28,0	24,83	24,07	16,0	19,5	26,0	6,5		
HD 28 - 3M 15	28	1	32,0	26,74	25,98	18,0	19,5	26,0	6,5		
HD 30 - 3M 15	30	1	32,0	28,65	27,89	20,0	19,5	26,0	6,5		
HD 32 - 3M 15	32	1	36,0	30,56	29,80	22,0	19,5	26,0	6,5		
HD 36 - 3M 15	36	1	39,0	34,38	33,62	26,0	20,0	30,0	10,0		
HD 40 - 3M 15	40	1	42,0	38,20	37,44	28,0	20,0	30,0	10,0		
HD 44 - 3M 15	44	1	48,0	42,02	41,26	33,0	20,0	30,0	10,0		
HD 48 - 3M 15	48	1A	-	45,84	45,08	33,0	20,0	30,0	10,0		
HD 60 - 3M 15	60	1A	-	57,30	56,54	33,0	20,0	30,0	10,0		
HD 72 - 3M 15	72	1A	-	68,75	67,99	33,0	20,0	30,0	10,0		

Dimensions of timing pulleys TOP DRIVE® HTD - solid hub



TIMING PULLEYS - HD

HD ... -5M09

5M

Code	Teeth nr.	Type	E [mm]	R [mm]	S [mm]	U [mm]	H [mm]	W [mm]	Y [mm]	Z [mm]	Flange	Material
HD 12 - 5M 09	12	1	23,0	19,10	17,96	-	12,0	14,5	20,0	5,5	with flanges	steel
HD 14 - 5M 09	14	1	25,0	22,28	21,14	-	13,0	14,5	20,0	5,5		
HD 15 - 5M 09	15	1	28,0	23,87	22,73	-	16,0	14,5	20,0	5,5		
HD 16 - 5M 09	16	1	28,0	25,47	24,32	-	16,5	14,5	20,0	5,5		
HD 18 - 5M 09	18	1	32,0	28,65	27,51	-	20,0	14,5	20,0	5,5		
HD 20 - 5M 09	20	1	36,0	31,83	30,69	-	23,0	14,5	22,5	8,0		
HD 21 - 5M 09	21	1	38,0	33,42	32,28	-	24,0	14,5	22,5	8,0		
HD 22 - 5M 09	22	1	39,0	35,01	33,87	-	25,5	14,5	22,5	8,0		
HD 24 - 5M 09	24	1	42,0	38,19	37,06	-	27,0	14,5	22,5	8,0		
HD 26 - 5M 09	26	1	44,0	41,38	40,24	-	30,0	14,5	22,5	8,0		
HD 28 - 5M 09	28	1	48,0	44,56	43,42	-	30,5	14,5	22,5	8,0		
HD 30 - 5M 09	30	1	51,0	47,75	46,61	-	35,0	14,5	22,5	8,0		
HD 32 - 5M 09	32	1	54,0	50,93	49,79	-	38,0	14,5	22,5	8,0		
HD 36 - 5M 09	36	1	60,0	57,30	56,16	-	38,0	14,5	22,5	8,0		
HD 40 - 5M 09	40	1	71,0	63,66	62,52	-	38,0	14,5	22,5	8,0		
HD 44 - 5M 09	44	1A	-	70,03	68,89	-	38,0	14,5	25,5	11,0		
HD 48 - 5M 09	48	1A	-	76,39	75,25	-	45,0	14,5	25,5	11,0		
HD 60 - 5M 09	60	1A	-	95,49	94,35	-	45,0	14,5	25,5	11,0		
HD 72 - 5M 09	72	3A	-	114,59	113,45	90	45,0	14,5	25,5	11,0		

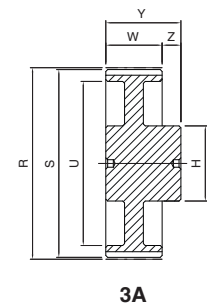
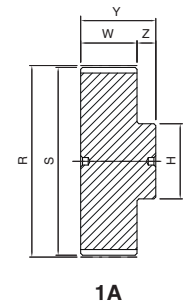
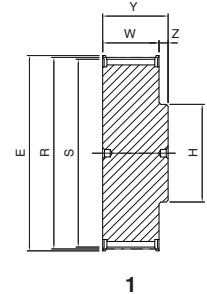

HD ... -5M15

5M

Code	Teeth nr.	Type	E [mm]	R [mm]	S [mm]	U [mm]	H [mm]	W [mm]	Y [mm]	Z [mm]	Flange	Material
HD 12 - 5M 15	12	1	23,0	19,10	17,96	-	12,0	20,5	26,0	5,5	with flanges	steel
HD 14 - 5M 15	14	1	25,0	22,28	21,14	-	13,0	20,5	26,0	5,5		
HD 15 - 5M 15	15	1	28,0	23,87	22,73	-	16,0	20,5	26,0	5,5		
HD 16 - 5M 15	16	1	28,0	25,47	24,32	-	16,5	20,5	26,0	5,5		
HD 18 - 5M 15	18	1	32,0	28,65	27,51	-	20,0	20,5	26,0	5,5		
HD 20 - 5M 15	20	1	36,0	31,83	30,69	-	23,0	20,5	26,0	5,5		
HD 21 - 5M 15	21	1	38,0	33,42	32,28	-	24,0	20,5	26,0	5,5		
HD 22 - 5M 15	22	1	39,0	35,01	33,87	-	25,5	20,5	26,0	5,5		
HD 24 - 5M 15	24	1	42,0	38,19	37,06	-	27,0	20,5	28,0	7,5		
HD 26 - 5M 15	26	1	44,0	41,38	40,24	-	30,0	20,5	28,0	7,5		
HD 28 - 5M 15	28	1	48,0	44,56	43,42	-	30,5	20,5	28,0	7,5		
HD 30 - 5M 15	30	1	51,0	47,75	46,61	-	35,0	20,5	28,0	7,5		
HD 32 - 5M 15	32	1	54,0	50,93	49,79	-	38,0	20,5	28,0	7,5		
HD 36 - 5M 15	36	1	60,0	57,30	56,16	-	38,0	20,5	28,0	7,5		
HD 40 - 5M 15	40	1	71,0	63,66	62,52	-	38,0	20,5	28,0	7,5		
HD 44 - 5M 15	44	1A	-	70,03	68,89	-	38,0	20,5	30,0	9,5		
HD 48 - 5M 15	48	1A	-	76,39	75,25	-	45,0	20,5	30,0	9,5		
HD 60 - 5M 15	60	1A	-	95,49	94,35	-	50,0	20,5	30,0	9,5		
HD 72 - 5M 15	72	3A	-	114,59	113,45	90	50,0	20,5	30,0	9,5		

Dimensions of timing pulleys TOP DRIVE® HTD - solid hub



HD ... -5M25

5M

Code	Teeth nr.	Type	E [mm]	R [mm]	S [mm]	U [mm]	H [mm]	W [mm]	Y [mm]	Z [mm]	Flange	Material
HD 12 - 5M 25	127	1	23,0	19,10	17,96	-	12,0	30,0	36,0	6,0	with flanges	steel
HD 14 - 5M 25	14	1	25,0	22,28	21,14	-	13,0	30,0	36,0	6,0		
HD 15 - 5M 25	15	1	28,0	23,87	22,73	-	16,0	30,0	36,0	6,0		
HD 16 - 5M 25	16	1	28,0	25,47	24,32	-	16,5	30,0	36,0	6,0		
HD 18 - 5M 25	18	1	32,0	28,65	27,51	-	20,0	30,0	36,0	6,0		
HD 20 - 5M 25	20	1	36,0	31,83	30,69	-	23,0	30,0	36,0	6,0		
HD 21 - 5M 25	21	1	38,0	33,42	32,28	-	24,0	30,0	38,0	8,0		
HD 22 - 5M 25	22	1	39,0	35,01	33,87	-	25,5	30,0	38,0	8,0		
HD 24 - 5M 25	24	1	42,0	38,19	37,06	-	27,0	30,0	38,0	8,0		
HD 26 - 5M 25	26	1	44,0	41,38	40,24	-	30,0	30,0	38,0	8,0		
HD 28 - 5M 25	28	1	48,0	44,56	43,42	-	30,5	30,0	38,0	8,0		
HD 30 - 5M 25	30	1	51,0	47,75	46,61	-	35,0	30,0	38,0	8,0		
HD 32 - 5M 25	32	1	54,0	50,93	49,79	-	38,0	30,0	38,0	8,0		
HD 36 - 5M 25	36	1	60,0	57,30	56,16	-	38,0	30,0	38,0	8,0		
HD 40 - 5M 25	40	1	71,0	63,66	62,52	-	38,0	30,0	38,0	8,0		
HD 44 - 5M 25	44	1A	-	70,03	68,89	-	38,0	30,0	40,0	10,0		
HD 48 - 5M 25	48	1A	-	76,39	75,25	-	45,0	30,0	40,0	10,0		
HD 60 - 5M 25	60	1A	-	95,49	94,35	-	50,0	30,0	40,0	10,0		
HD 72 - 5M 25	72	3A	-	114,59	113,45	90	50,0	30,0	40,0	10,0		

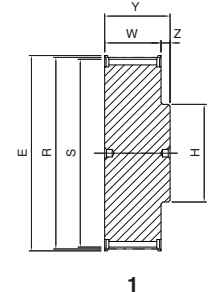

1

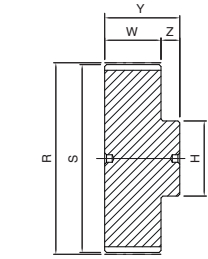

1A

HD ... -8M20

8M

Code	Teeth nr.	Type	E [mm]	R [mm]	S [mm]	U [mm]	H [mm]	d [mm]	W [mm]	Y [mm]	Z [mm]	Flange	Material
HD 18 - 8M 20	18	1	51,0	45,84	44,46	-	32,0	-	28	38	10	with flanges	steel
HD 20 - 8M 20	20	1	57,0	50,93	49,56	-	36,0	-	28	38	10		
HD 22 - 8M 20	22	1	60,0	56,02	54,65	-	43,0	-	28	38	10		
HD 24 - 8M 20	24	1	66,0	61,12	59,74	-	45,0	-	28	38	10		
HD 26 - 8M 20	26	1	70,0	66,21	64,84	-	48,0	-	28	38	10		
HD 28 - 8M 20	28	1	75,0	71,30	70,08	-	55,0	-	28	38	10		
HD 30 - 8M 20	30	1	83,0	76,39	75,13	-	60,0	-	28	38	10		
HD 32 - 8M 20	32	1	87,0	81,49	80,16	-	64,0	-	28	38	10		
HD 34 - 8M 20	34	1	91,0	86,58	85,21	-	70,0	-	28	38	10		
HD 36 - 8M 20	36	1	97,0	91,67	90,30	-	75,0	-	28	38	10		
HD 38 - 8M 20	38	1	102,0	96,77	95,39	-	80,0	-	28	38	10		
HD 40 - 8M 20	40	1	106,0	101,86	100,49	-	85,0	-	28	38	10		
HD 44 - 8M 20	44	1	120,0	112,05	110,67	-	96,0	-	28	38	10		
HD 48 - 8M 20	48	1	128,0	122,23	120,86	-	104,0	-	28	38	10		
HD 56 - 8M 20	56	5	150,0	142,60	141,23	117	80,0	12	28	38	10		
HD 60 - 8M 20	60	5	158,0	152,79	151,42	127	80,0	12	28	38	10		
HD 64 - 8M 20	64	5	168,0	162,97	161,60	137	80,0	12	28	38	10		
HD 72 - 8M 20	72	5	192,0	183,35	181,97	158	80,0	12	28	38	10		
HD 80 - 8M 20	80	5A	-	203,72	202,35	179	90,0	12	28	38	10		
HD 84 - 8M 20	84	5A	-	213,90	212,53	190	90,0	12	28	38	10		
HD 90 - 8M 20	90	5A	-	229,18	227,81	204	90,0	12	28	38	10		
HD 112 - 8M 20	112	5B	-	285,21	283,83	260	90,0	18	28	38	10		
HD 144 - 8M 20	144	5B	-	366,69	365,32	342	90,0	20	28	38	10		
HD 168 - 8M 20	168	5B	-	427,80	426,44	403	100,0	20	28	38	10		
HD 192 - 8M 20	192	5B	-	488,92	487,54	465	100,0	20	28	38	10		

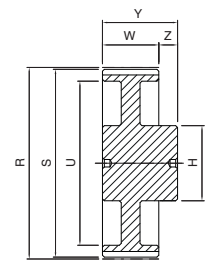

3A

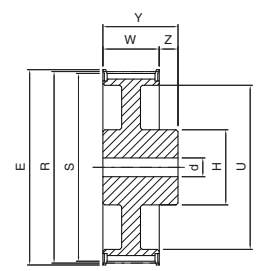

5

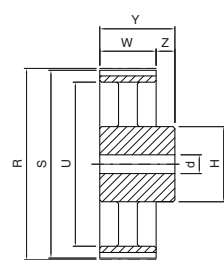

5B

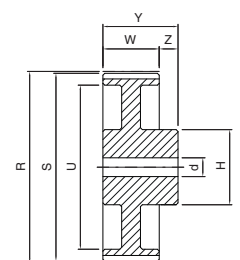

5A

Dimensions of timing pulleys TOP DRIVE® HTD - solid hub



TIMING PULLEYS - HD

HD ... -8M30

8M

Code	Teeth nr.	Type	E [mm]	R [mm]	S [mm]	U [mm]	H [mm]	d [mm]	W [mm]	Y [mm]	Z [mm]	Flange	Material
HD 18 - 8M 30	18	1	51,0	45,84	44,46	-	32,0	-	38	48	10	with flanges	steel
HD 20 - 8M 30	20	1	57,0	50,93	49,56	-	36,0	-	38	48	10		
HD 22 - 8M 30	22	1	60,0	56,02	54,65	-	43,0	-	38	48	10		
HD 24 - 8M 30	24	1	66,0	61,12	59,74	-	45,0	-	38	48	10		
HD 26 - 8M 30	26	1	70,0	66,21	64,84	-	48,0	-	38	48	10		
HD 28 - 8M 30	28	1	75,0	71,30	70,08	-	55,0	-	38	48	10		
HD 30 - 8M 30	30	1	83,0	76,39	75,13	-	60,0	-	38	48	10		
HD 32 - 8M 30	32	1	87,0	81,49	80,16	-	64,0	-	38	48	10		
HD 34 - 8M 30	34	1	91,0	86,58	85,21	-	70,0	-	38	48	10		
HD 36 - 8M 30	36	1	97,0	91,67	90,30	-	75,0	-	38	48	10		
HD 38 - 8M 30	38	1	102,0	96,77	95,39	-	80,0	-	38	48	10		
HD 40 - 8M 30	40	1	106,0	101,86	100,49	-	85,0	-	38	48	10		
HD 44 - 8M 30	44	1	120,0	112,05	110,67	-	96,0	-	38	48	10		
HD 48 - 8M 30	48	1	128,0	122,23	120,86	-	104,0	-	38	48	10		
HD 56 - 8M 30	56	5	150,0	142,60	141,23	117	90,0	12	38	48	10		
HD 60 - 8M 30	60	5	158,0	152,79	151,42	127	90,0	12	38	48	10		
HD 64 - 8M 30	64	5	168,0	162,97	161,60	137	90,0	12	38	48	10		
HD 72 - 8M 30	72	5	192,0	183,35	181,97	158	95,0	12	38	48	10		
HD 80 - 8M 30	80	5A	-	203,72	202,35	179	100,0	12	38	48	10		
HD 84 - 8M 30	84	5A	-	213,90	212,53	190	100,0	12	38	48	10		
HD 90 - 8M 30	90	5A	-	229,18	227,81	204	100,0	12	38	48	10		
HD 112 - 8M 30	112	5B	-	285,21	283,83	260	100,0	18	38	48	10		
HD 144 - 8M 30	144	5B	-	366,69	365,32	342	100,0	20	38	48	10		
HD 168 - 8M 30	168	5B	-	427,80	426,44	403	100,0	20	38	48	10		
HD 192 - 8M 30	192	5B	-	488,92	487,54	465	100,0	20	38	48	10		

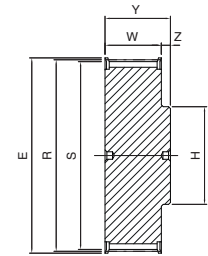

1

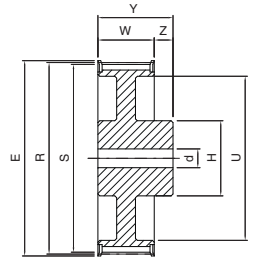

5

HD ... -8M50

8M

Code	Teeth nr.	Type	E [mm]	R [mm]	S [mm]	U [mm]	H [mm]	d [mm]	W [mm]	Y [mm]	Z [mm]	Flange	Material
HD 18 - 8M 50	18	1	51,0	45,84	44,46	-	32,0	-	60	70	10	with flanges	steel
HD 20 - 8M 50	20	1	57,0	50,93	49,56	-	36,0	-	60	70	10		
HD 22 - 8M 50	22	1	60,0	56,02	54,65	-	43,0	-	60	70	10		
HD 24 - 8M 50	24	1	66,0	61,12	59,74	-	49,0	-	60	70	10		
HD 26 - 8M 50	26	1	70,0	66,21	64,84	-	50,0	-	60	70	10		
HD 28 - 8M 50	28	1	75,0	71,30	70,08	-	55,0	-	60	70	10		
HD 30 - 8M 50	30	1	83,0	76,39	75,13	-	60,0	-	60	70	10		
HD 32 - 8M 50	32	1	87,0	81,49	80,16	-	64,0	-	60	70	10		
HD 34 - 8M 50	34	1	91,0	86,58	85,21	-	70,0	-	60	70	10		
HD 36 - 8M 50	36	1	97,0	91,67	90,30	-	75,0	-	60	70	10		
HD 38 - 8M 50	38	1	102,0	96,77	95,39	-	80,0	-	60	70	10		
HD 40 - 8M 50	40	1	106,0	101,86	100,49	-	85,0	-	60	70	10		
HD 44 - 8M 50	44	1	120,0	112,05	110,67	-	96,0	-	60	70	10		
HD 48 - 8M 50	48	1	128,0	122,23	120,86	-	104,0	-	60	70	10		
HD 56 - 8M 50	56	7	150,0	142,60	141,23	117	90,0	18	60	60	-		
HD 60 - 8M 50	60	7	158,0	152,79	151,42	127	100,0	18	60	60	-		
HD 64 - 8M 50	64	7	168,0	162,97	161,60	137	100,0	18	60	60	-		
HD 72 - 8M 50	72	7	192,0	183,35	181,97	158	100,0	18	60	60	-		
HD 80 - 8M 50	80	7A	-	203,72	202,35	179	110,0	18	60	60	-		
HD 84 - 8M 50	84	7B	-	213,90	212,53	190	110,0	18	60	60	-		
HD 90 - 8M 50	90	7B	-	229,18	227,81	204	110,0	18	60	60	-		
HD 112 - 8M 50	112	7B	-	285,21	283,83	260	110,0	18	60	60	-		
HD 144 - 8M 50	144	7B	-	366,69	365,32	342	110,0	20	60	60	-		
HD 168 - 8M 50	168	7B	-	427,80	426,44	403	120,0	20	60	60	-		
HD 192 - 8M 50	192	7B	-	488,92	487,54	465	130,0	20	60	60	-		

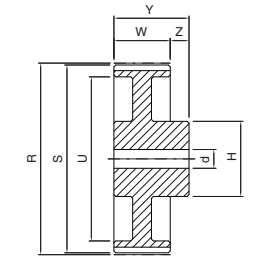

5A

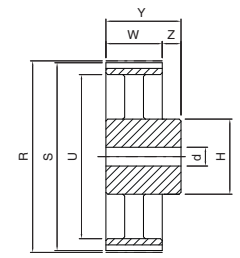

5B

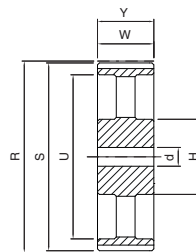

7B

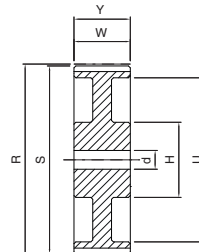

7A

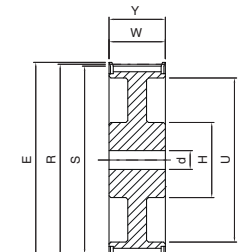

7

Dimensions of timing pulleys TOP DRIVE® HTD - solid hub



HD ... -8M85

8M

Code	Teeth nr.	Type	E [mm]	R [mm]	S [mm]	U [mm]	H [mm]	d [mm]	W [mm]	Y [mm]	Z [mm]	Flange	Material
HD 22 - 8M 85	22	1	60,0	56,02	54,65	-	43,0	-	95	105	10	with flanges	steel
HD 24 - 8M 85	24	1	66,0	61,12	59,74	-	45,0	-	95	105	10		
HD 26 - 8M 85	26	1	70,0	66,21	64,84	-	48,0	-	95	105	10		
HD 28 - 8M 85	28	1	75,0	71,30	70,08	-	55,0	-	95	105	10		
HD 30 - 8M 85	30	1	83,0	76,39	75,13	-	60,0	-	95	105	10		
HD 32 - 8M 85	32	1	87,0	81,49	80,16	-	64,0	-	95	105	10		
HD 34 - 8M 85	34	1	91,0	86,58	85,21	-	70,0	-	95	105	10		
HD 36 - 8M 85	36	1	97,0	91,67	90,30	-	75,0	-	95	105	10		
HD 38 - 8M 85	38	1	102,0	96,77	95,39	-	80,0	-	95	105	10		
HD 40 - 8M 85	40	1	106,0	101,86	100,49	-	85,0	-	95	105	10		
HD 44 - 8M 85	44	1	120,0	112,05	110,67	-	96,0	-	95	105	10		
HD 48 - 8M 85	48	1	128,0	122,23	120,86	-	100,0	-	95	105	10		
HD 56 - 8M 85	56	1	150,0	142,60	141,23	-	107,0	-	95	105	10		
HD 60 - 8M 85	60	1	158,0	152,79	151,42	-	132,0	-	95	105	10		
HD 64 - 8M 85	64	7	168,0	162,97	161,60	137	100,0	18	95	95	-		
HD 72 - 8M 85	72	7	192,0	183,35	181,97	158	110,0	18	95	95	-		
HD 80 - 8M 85	80	7A	-	203,72	202,35	179	110,0	20	95	95	-		
HD 84 - 8M 85	84	7A	-	213,90	212,53	190	110,0	20	95	95	-		
HD 90 - 8M 85	90	7B	-	229,18	227,81	204	110,0	20	95	95	-		
HD 112 - 8M 85	112	7B	-	285,21	283,83	260	110,0	24	95	95	-		
HD 144 - 8M 85	144	7B	-	366,69	365,32	342	120,0	24	95	95	-		
HD 168 - 8M 85	168	7B	-	427,80	426,44	403	120,0	24	95	95	-		
HD 192 - 8M 85	192	7B	-	488,92	487,54	465	130,0	24	95	95	-		

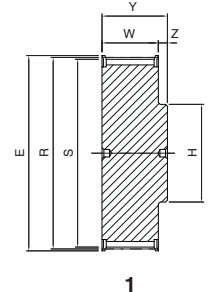

1

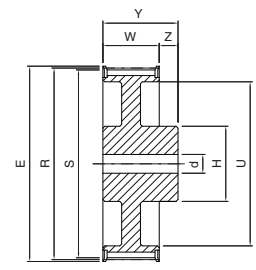

5

HD ... -14M40

14M

Code	Teeth nr.	Type	E [mm]	R [mm]	S [mm]	U [mm]	H [mm]	d [mm]	W [mm]	Y [mm]	Z [mm]	Flange	Material
HD 28 - 14M 40	28	1	128,0	124,78	122,12	-	100,0	-	54	69	15	with flanges	steel
HD 29 - 14M 40	29	1	138,0	129,23	126,57	-	107,0	-	54	69	15		
HD 30 - 14M 40	30	1	138,0	133,69	130,99	-	107,0	-	54	69	15		
HD 32 - 14M 40	32	1	154,0	142,60	139,88	-	114,0	-	54	69	15		
HD 34 - 14M 40	34	1	160,0	151,51	148,79	-	122,0	-	54	69	15		
HD 36 - 14M 40	36	1	168,0	160,43	157,68	-	128,0	-	54	69	15		
HD 38 - 14M 40	38	1	183,0	169,34	166,60	-	141,0	-	54	69	15		
HD 40 - 14M 40	40	1	198,0	178,25	175,49	-	148,0	-	54	69	15		
HD 44 - 14M 40	44	5	211,0	196,08	193,28	154	120,0	24	54	69	15		
HD 48 - 14M 40	48	5	226,0	213,90	211,11	172	135,0	24	54	69	15		
HD 56 - 14M 40	56	5	256,0	249,55	246,76	207	135,0	28	54	69	15		
HD 60 - 14M 40	60	5	275,0	267,38	264,59	225	135,0	28	54	69	15		
HD 64 - 14M 40	64	5	296,0	285,21	282,41	243	135,0	28	54	69	15		
HD 72 - 14M 40	72	5B	-	320,86	318,06	279	135,0	28	54	69	15		
HD 80 - 14M 40	80	5B	-	356,51	353,71	314	135,0	28	54	69	15		
HD 84 - 14M 40	84	5B	-	374,33	371,54	332	135,0	28	54	69	15		
HD 90 - 14M 40	90	5B	-	401,07	398,28	359	135,0	28	54	69	15		
HD 112 - 14M 40	112	5B	-	499,11	496,32	457	135,0	28	54	69	15		
HD 144 - 14M 40	144	5B	-	641,71	638,92	600	135,0	28	54	69	15		

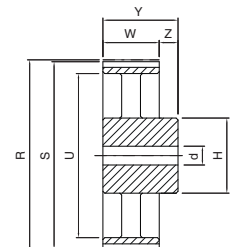

5B

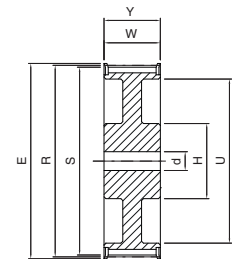

7

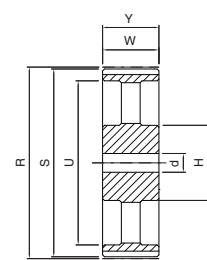

7B

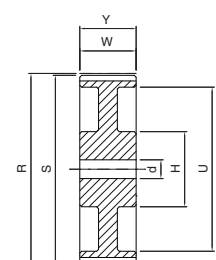

7A

Dimensions of timing pulleys TOP DRIVE® HTD - solid hub



TIMING PULLEYS - HD

HD ... -14M55

14M

Code	Teeth nr.	Type	E [mm]	R [mm]	S [mm]	U [mm]	H [mm]	d [mm]	W [mm]	Y [mm]	Z [mm]	Flange	Material
HD 28 - 14M 55	28	1	128,0	124,78	122,12	-	100,0	-	70	85	15	with flanges	steel
HD 29 - 14M 55	29	1	138,0	129,23	126,57	-	107,0	-	70	85	15		
HD 30 - 14M 55	30	1	138,0	133,69	130,99	-	107,0	-	70	85	15		
HD 32 - 14M 55	32	1	154,0	142,60	139,88	-	114,0	-	70	85	15		
HD 34 - 14M 55	34	1	160,0	151,51	148,79	-	122,0	-	70	85	15		
HD 36 - 14M 55	36	1	168,0	160,43	157,68	-	128,0	-	70	85	15		
HD 38 - 14M 55	38	1	183,0	169,34	166,60	-	141,0	-	70	85	15		
HD 40 - 14M 55	40	1	198,0	178,25	175,49	-	148,0	-	70	85	15		
HD 44 - 14M 55	44	5	211,0	196,08	193,28	154	120,0	24	70	85	15		
HD 48 - 14M 55	48	7	226,0	213,90	211,11	172	135,0	24	70	70	-		
HD 56 - 14M 55	56	7	256,0	249,55	246,76	207	135,0	28	70	70	-		
HD 60 - 14M 55	60	7	275,0	267,38	264,59	225	135,0	28	70	70	-		
HD 64 - 14M 55	64	7	296,0	285,21	282,41	243	135,0	28	70	70	-		
HD 72 - 14M 55	72	7B	-	320,86	318,06	279	135,0	28	70	70	-		
HD 80 - 14M 55	80	7B	-	356,51	353,71	314	135,0	28	70	70	-		
HD 84 - 14M 55	84	7B	-	374,33	371,54	332	135,0	28	70	70	-		
HD 90 - 14M 55	90	7B	-	401,07	398,28	359	135,0	28	70	70	-		
HD 112 - 14M 55	112	7B	-	499,11	496,32	457	135,0	28	70	70	-		
HD 144 - 14M 55	144	7B	-	641,71	638,92	600	135,0	28	70	70	-		

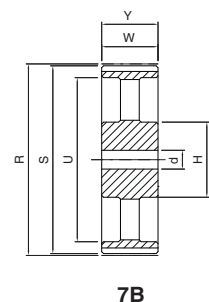
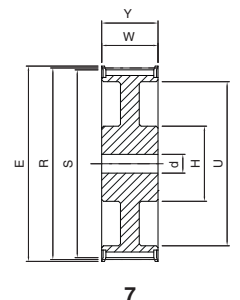
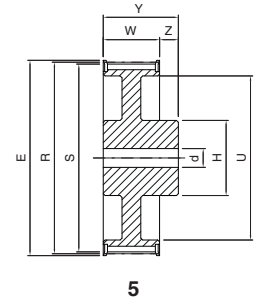
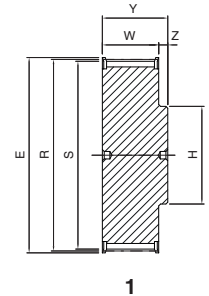

HD ... -14M85

14M

Code	Teeth nr.	Type	E [mm]	R [mm]	S [mm]	U [mm]	H [mm]	d [mm]	W [mm]	Y [mm]	Z [mm]	Flange	Material
HD 28 - 14M 85	28	1	128,0	124,78	122,12	-	100,0	-	102	117	15	with flanges	steel
HD 29 - 14M 85	29	1	138,0	129,23	126,57	-	107,0	-	102	117	15		
HD 30 - 14M 85	30	1	138,0	133,69	130,99	-	107,0	-	102	117	15		
HD 32 - 14M 85	32	1	154,0	142,60	139,88	-	114,0	-	102	117	15		
HD 34 - 14M 85	34	1	160,0	151,51	148,79	-	122,0	-	102	117	15		
HD 36 - 14M 85	36	1	168,0	160,43	157,68	-	128,0	-	102	117	15		
HD 38 - 14M 85	38	1	183,0	169,34	166,60	-	141,0	-	102	117	15		
HD 40 - 14M 85	40	1	198,0	178,25	175,49	-	148,0	-	102	117	15		
HD 44 - 14M 85	44	1	211,0	196,08	193,28	-	169,0	-	102	117	15		
HD 48 - 14M 85	48	1	226,0	213,90	211,11	-	186,0	-	102	117	15		
HD 56 - 14M 85	56	7	256,0	249,55	246,76	207	150,0	32	102	102	-		
HD 60 - 14M 85	60	7	275,0	267,38	264,59	225	150,0	32	102	102	-		
HD 64 - 14M 85	64	7	296,0	285,21	282,41	243	150,0	32	102	102	-		
HD 72 - 14M 85	72	7B	-	320,86	318,06	279	150,0	32	102	102	-		
HD 80 - 14M 85	80	7B	-	356,51	353,71	314	150,0	32	102	102	-		
HD 84 - 14M 85	84	7B	-	374,33	371,54	332	150,0	32	102	102	-		
HD 90 - 14M 85	90	7B	-	401,07	398,28	359	150,0	32	102	102	-		
HD 112 - 14M 85	112	7B	-	499,11	496,32	457	150,0	32	102	102	-		
HD 144 - 14M 85	144	7B	-	641,71	638,92	600	150,0	32	102	102	-		

Dimensions of timing pulleys TOP DRIVE® HTD - solid hub



HD ... -14M115

14M

Code	Teeth nr.	Type	E [mm]	R [mm]	S [mm]	U [mm]	H [mm]	d [mm]	W [mm]	Y [mm]	Z [mm]	Flange	Material
HD 28 - 14M 115	28	1	128,0	124,78	122,12	-	100,0	-	133	148	15	with flanges	steel
HD 29 - 14M 115	29	1	138,0	129,23	126,57	-	107,0	-	133	148	15		
HD 30 - 14M 115	30	1	138,0	133,69	130,99	-	107,0	-	133	148	15		
HD 32 - 14M 115	32	1	154,0	142,60	139,88	-	114,0	-	133	148	15		
HD 34 - 14M 115	34	1	160,0	151,51	148,79	-	122,0	-	133	148	15		
HD 36 - 14M 115	36	1	168,0	160,43	157,68	-	128,0	-	133	148	15		
HD 38 - 14M 115	38	1	183,0	169,34	166,60	-	141,0	-	133	148	15		
HD 40 - 14M 115	40	1	198,0	178,25	175,49	-	148,0	-	133	148	15		
HD 44 - 14M 115	44	1	211,0	196,08	193,28	-	169,0	-	133	148	15		
HD 48 - 14M 115	48	1	226,0	213,90	211,11	-	186,0	-	133	148	15		
HD 56 - 14M 115	56	5	256,0	249,55	246,76	207	150,0	32	133	148	15		
HD 60 - 14M 115	60	7	290,0	267,38	264,59	225	150,0	32	133	133	-		
HD 64 - 14M 115	64	7	296,0	285,21	282,41	243	150,0	32	133	133	-		
HD 72 - 14M 115	72	7B	-	320,86	318,06	279	150,0	32	133	133	-		
HD 80 - 14M 115	80	7B	-	356,51	353,71	314	150,0	32	133	133	-		
HD 84 - 14M 115	84	7B	-	374,33	371,54	332	150,0	32	133	133	-		
HD 90 - 14M 115	90	7B	-	401,07	398,28	359	150,0	32	133	133	-		
HD 112 - 14M 115	112	7B	-	499,11	496,32	457	150,0	32	133	133	-		
HD 144 - 14M 115	144	7B	-	641,71	638,92	600	150,0	32	133	133	-		

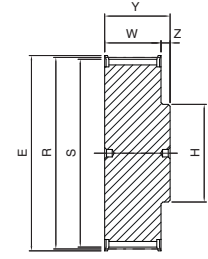

1

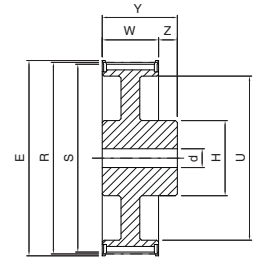

5

HD ... -14M170

14M

Code	Teeth nr.	Type	E [mm]	R [mm]	S [mm]	U [mm]	H [mm]	d [mm]	W [mm]	Y [mm]	Z [mm]	Flange	Material
HD 28 - 14M 170	28	1	128,0	124,78	122,12	-	100,0	-	187	202	15	with flanges	steel
HD 29 - 14M 170	29	1	138,0	129,23	126,57	-	107,0	-	187	202	15		
HD 30 - 14M 170	30	1	138,0	133,69	130,99	-	107,0	-	187	202	15		
HD 32 - 14M 170	32	1	154,0	142,60	139,88	-	114,0	-	187	202	15		
HD 34 - 14M 170	34	1	160,0	151,51	148,79	-	122,0	-	187	202	15		
HD 36 - 14M 170	36	1	168,0	160,43	157,68	-	128,0	-	187	202	15		
HD 38 - 14M 170	38	1	183,0	169,34	166,60	-	141,0	-	187	202	15		
HD 40 - 14M 170	40	1	198,0	178,25	175,49	-	148,0	-	187	202	15		
HD 44 - 14M 170	44	1	211,0	196,08	193,28	-	169,0	-	187	202	15		
HD 48 - 14M 170	48	1	226,0	213,90	211,11	-	186,0	-	187	202	15		
HD 56 - 14M 170	56	5	256,0	249,55	246,76	207	160,0	32	187	202	15		
HD 60 - 14M 170	60	5	290,0	267,38	264,59	225	160,0	32	187	202	15		
HD 64 - 14M 170	64	5	296,0	285,21	282,41	243	180,0	32	187	202	15		
HD 72 - 14M 170	72	7A	-	320,86	318,06	279	180,0	32	187	187	-		
HD 80 - 14M 170	80	7A	-	356,51	353,71	314	180,0	32	187	187	-		
HD 84 - 14M 170	84	7B	-	374,33	371,54	332	180,0	32	187	187	-		
HD 90 - 14M 170	90	7B	-	401,07	398,28	359	180,0	32	187	187	-		
HD 112 - 14M 170	112	7B	-	499,11	496,32	456	200,0	32	187	187	-		
HD 144 - 14M 170	144	7B	-	641,71	638,92	600	220,0	32	187	187	-		

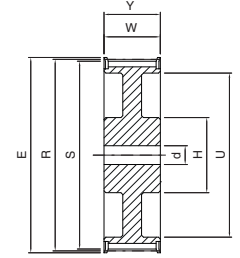

7

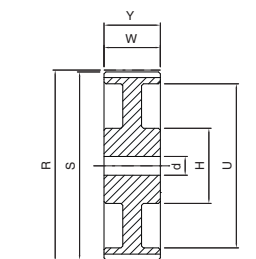

7A

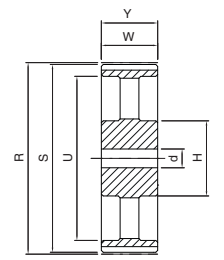

7B

Dimensions of timing pulleys TOP DRIVE® HTD - mounting taper bushing SER-SIT® pitches 5M - 8M - 14M



TIMING PULLEYS - HDB

Part Number **HDB 32 - 8M 20**

HTD pulley - mounting taper bushing

Number of teeth

Pitch

Belt width in mm

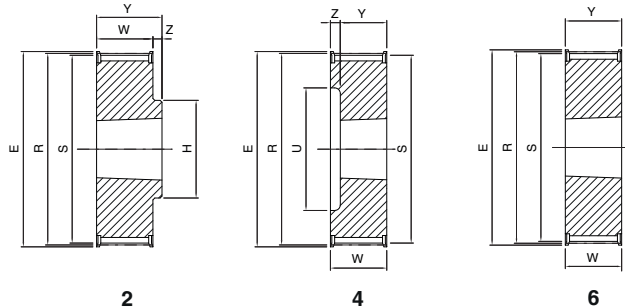

HDB ... -5M15

Code	Teeth nr.	Type	SER-SIT® Taper bushing	E [mm]	R [mm]	S [mm]	U [mm]	H [mm]	W [mm]	Y [mm]	Z [mm]	Flange	Material
HDB 34 - 5M 15	34	6	1008	57,0	54,11	52,97	-	-	22	22	-	with flanges	steel
HDB 36 - 5M 15	36	6	1108	60,0	57,3	56,16	-	-	22	22	-		
HDB 38 - 5M 15	38	6	1108	66,5	60,48	59,34	-	-	22	22	-		
HDB 40 - 5M 15	40	6	1108	71,0	63,66	62,52	-	-	22	22	-		
HDB 44 - 5M 15	44	6	1108	75,0	70,03	68,89	-	-	22	22	-		
HDB 48 - 5M 15	48	2	1210	83,0	76,39	75,25	-	62,0	20,5	25	4,5		
HDB 56 - 5M 15	56	2	1210	93,0	89,13	87,99	-	70,0	20,5	25	4,5		
HDB 64 - 5M 15	64	2	1210	106,0	101,86	100,72	-	80,0	20,5	25	4,5		
HDB 72 - 5M 15	72	2	1610	119,0	114,59	113,45	-	92,0	20,5	25	4,5		
HDB 80 - 5M 15	80	2	1610	135,0	127,32	126,18	-	92,0	20,5	25	4,5		
HDB 90 - 5M 15	90	11A	1610	-	143,24	142,10	122	92,0	20,5	25	4,5	without flanges	cast iron
HDB 112 - 5M 15	112	11A	1610	-	178,25	177,11	157	110,0	20,5	25	4,5		
HDB 136 - 5M 15	136	11A	2012	-	216,45	215,31	195	110,0	20,5	32	5,8		
HDB 150 - 5M 15	150	11A	2012	-	238,73	237,59	217	110,0	20,5	32	5,8		

5M

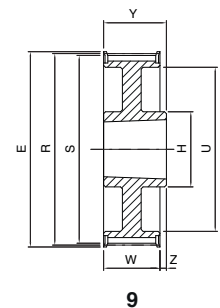

9

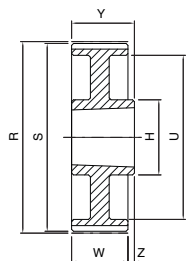

9A

HDB ... -8M20

Code	Teeth nr.	Type	SER-SIT® Taper bushing	E [mm]	R [mm]	S [mm]	U [mm]	H [mm]	W [mm]	Y [mm]	Z [mm]	Flange	Material
HDB 22 - 8M 20	22	4	1008	60,0	56,02	54,65	38	-	28	22	6	with flanges	steel
HDB 24 - 8M 20	24	4	1108	66,0	61,12	59,74	42	-	28	22	6		
HDB 26 - 8M 20	26	4	1108	70,0	66,21	64,84	45	-	28	22	6		
HDB 28 - 8M 20	28	4	1108	75,0	71,30	70,08	52	-	28	22	6		
HDB 30 - 8M 20	30	4	1108	83,0	76,39	75,13	56	-	28	22	6		
HDB 32 - 8M 20	32	4	1610	87,0	81,49	80,16	65	-	28	25	3		
HDB 34 - 8M 20	34	4	1610	91,0	86,58	85,21	66	-	28	25	3		
HDB 36 - 8M 20	36	4	1610	97,0	91,67	90,30	68	-	28	25	3		
HDB 38 - 8M 20	38	4	1610	102,0	96,77	95,39	76	-	28	25	3		
HDB 40 - 8M 20	40	4	1610	106,0	101,86	100,49	80	-	28	25	3		
HDB 44 - 8M 20	44	2	2012	120,0	112,05	110,67	-	93,0	28	32	4		
HDB 48 - 8M 20	48	2	2012	128,0	122,23	120,86	-	100,0	28	32	4		
HDB 56 - 8M 20	56	2	2012	150,0	142,60	141,23	-	110,0	28	32	4		
HDB 64 - 8M 20	64	9	2012	168,0	162,97	161,60	140	110,0	28	32	4		
HDB 72 - 8M 20	72	9	2012	192,0	183,35	181,97	158	110,0	28	32	4		
HDB 80 - 8M 20	80	9A	2012	-	203,74	202,35	178	110,0	28	32	4	without flanges	cast iron
HDB 90 - 8M 20	90	9B	2012	-	229,18	227,81	204	110,0	28	32	4		

8M

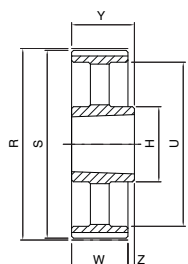

9B

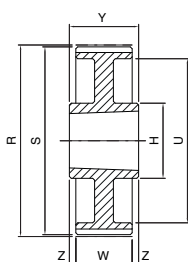

11A

Dimensions of timing pulleys TOP DRIVE® HTD - mounting taper bushing SER-SIT®



HDB ... -8M30

8M

Code	Teeth nr.	Type	SER-SIT® Taper bushing	E [mm]	R [mm]	S [mm]	U [mm]	H [mm]	W [mm]	Y [mm]	Z [mm]	Flange	Material
HDB 22 - 8M 30	22	4	1008	60,0	56,02	54,65	38	-	38	22	16	with flanges	steel
HDB 24 - 8M 30	24	4	1108	66,0	61,12	59,74	42	-	38	22	16		
HDB 26 - 8M 30	26	4	1108	70,0	66,21	64,84	45	-	38	22	16		
HDB 28 - 8M 30	28	4	1108	75,0	71,30	70,08	52	-	38	22	16		
HDB 30 - 8M 30	30	6	1615	83,0	76,39	75,13	-	-	38	38	-		
HDB 32 - 8M 30	32	6	1615	87,0	81,49	80,16	-	-	38	38	-		
HDB 34 - 8M 30	34	6	1615	91,0	86,58	85,21	-	-	38	38	-		
HDB 36 - 8M 30	36	6	1615	97,0	91,67	90,30	-	-	38	38	-		
HDB 38 - 8M 30	38	6	1615	102,0	96,77	95,39	-	-	38	38	-		
HDB 40 - 8M 30	40	6	1615	106,0	101,86	100,49	-	-	38	38	-		
HDB 44 - 8M 30	44	5	2012	120,0	112,05	110,67	90	-	38	32	3		
HDB 48 - 8M 30	48	5	2012	128,0	122,23	120,86	100	-	38	32	3		
HDB 56 - 8M 30	56	5	2012	150,0	142,60	141,23	118	-	38	32	3		
HDB 64 - 8M 30	64	2	2517	168,0	162,97	161,60	140	125,0	38	45	7		
HDB 72 - 8M 30	72	9	2517	192,0	183,35	181,97	158	125,0	38	45	7		
HDB 80 - 8M 30	80	9A	2517	-	203,74	202,35	178	125,0	38	45	7		
HDB 90 - 8M 30	90	9B	2517	-	229,18	227,81	204	120,0	38	45	7		
HDB 112 - 8M 30	112	9B	2517	-	285,21	283,83	260	125,0	38	45	7		
HDB 144 - 8M 30	144	9B	2517	-	366,69	365,32	341	125,0	38	45	7		

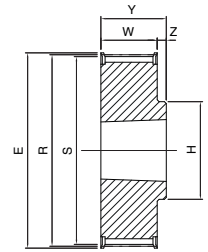

2

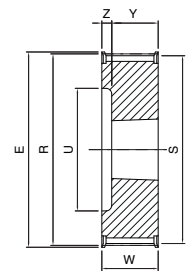

4

HDB ... -8M50

8M

Code	Teeth nr.	Type	SER-SIT® Taper bushing	E [mm]	R [mm]	S [mm]	U [mm]	H [mm]	W [mm]	Y [mm]	Z [mm]	Flange	Material
HDB 28 - 8M 50	28	5	1108	75,0	71,30	70,08	52	-	60	22	19,0	with flanges	steel
HDB 30 - 8M 50	30	4	1615	83,0	76,39	75,13	58	-	60	38	22,0		
HDB 32 - 8M 50	32	4	1615	87,0	81,49	80,16	60	-	60	38	22,0		
HDB 34 - 8M 50	34	4	1615	91,0	86,58	85,21	66	-	60	38	22,0		
HDB 36 - 8M 50	36	4	1615	97,0	91,67	90,30	68	-	60	38	22,0		
HDB 38 - 8M 50	38	4	1615	102,0	96,77	95,39	75	-	60	38	22,0		
HDB 40 - 8M 50	40	5	2012	106,0	101,86	100,49	80	-	60	32	14,0		
HDB 44 - 8M 50	44	5	2012	120,0	112,05	110,67	90	-	60	32	14,0		
HDB 48 - 8M 50	48	5	2012	128,0	122,23	120,86	100	-	60	32	14,0		
HDB 56 - 8M 50	56	5	2517	150,0	142,60	141,23	120	-	60	45	7,5		
HDB 64 - 8M 50	64	8	2517	168,0	162,97	161,60	138	120,0	60	45	7,5		
HDB 72 - 8M 50	72	8	2517	192,0	183,35	181,97	158	125,0	60	45	7,5		
HDB 80 - 8M 50	80	8A	3020	-	203,74	202,35	178	160,0	60	51	4,5		
HDB 90 - 8M 50	90	8A	3020	-	229,18	227,81	204	170,0	60	51	4,5		
HDB 112 - 8M 50	112	8B	3020	-	285,21	283,83	260	170,0	60	51	4,5		
HDB 144 - 8M 50	144	8B	3020	-	366,69	365,32	341	170,0	60	51	4,5		
HDB 168 - 8M 50	168	8B	3020	-	427,80	426,42	402	198,0	60	51	4,5		
HDB 192 - 8M 50	192	8B	3020	-	488,92	487,54	462	198,0	60	51	4,5		

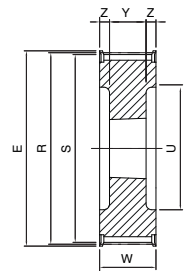

5

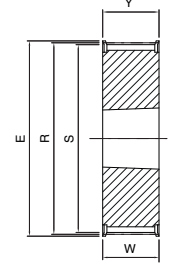

6

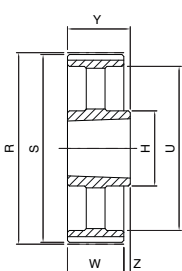

9B

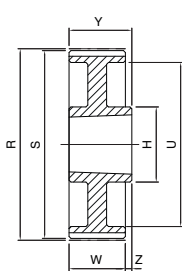

9A

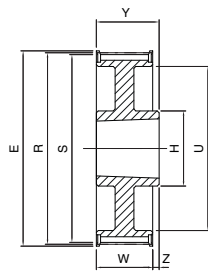

9

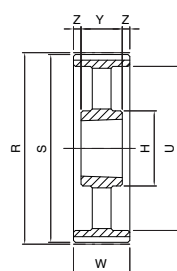

8B

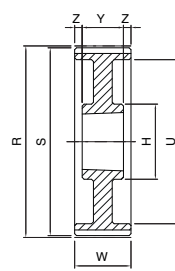

8A

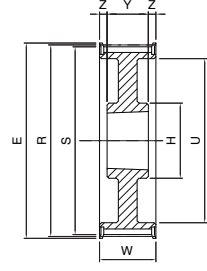

8

Dimensions of timing pulleys TOP DRIVE® HTD - mounting taper bushing SER-SIT®



HDB ... -8M85

8M

Code	Teeth nr.	Type	SER-SIT® Taper bushing	E [mm]	R [mm]	S [mm]	U [mm]	H [mm]	W [mm]	Y [mm]	Z [mm]	Flange	Material
HDB 34 - 8M 85	34	5	1615	91,0	86,58	85,21	66	-	95	38	28,5	with flanges	steel
HDB 36 - 8M 85	36	5	1615	97,0	91,67	90,30	68	-	95	38	28,5		
HDB 38 - 8M 85	38	5	1615	102,0	96,77	95,39	75	-	95	38	28,5		
HDB 40 - 8M 85	40	5	2012	106,0	101,86	100,49	80	-	95	32	31,5		
HDB 44 - 8M 85	44	5	2012	120,0	112,05	110,67	90	-	95	32	31,5		
HDB 48 - 8M 85	48	5	2517	128,0	122,23	120,86	100	-	95	45	25,0		
HDB 56 - 8M 85	56	5	2517	150,0	142,60	141,23	120	-	95	45	25,0		
HDB 64 - 8M 85	64	5	2517	168,0	162,97	161,60	138	-	95	45	25,0		
HDB 72 - 8M 85	72	5	3020	192,0	183,35	181,97	158	-	95	51	22,0		
HDB 80 - 8M 85	80	8A	3020	-	203,74	202,35	178	160,0	95	51	22,0		
HDB 90 - 8M 85	90	8A	3020	-	229,18	227,81	204	170,0	95	51	22,0		
HDB 112 - 8M 85	112	8B	3020	-	285,21	283,83	260	170,0	95	51	22,0		
HDB 144 - 8M 85	144	8B	3030	-	366,69	365,32	341	198,0	95	76	9,5		
HDB 168 - 8M 85	168	8B	3030	-	427,80	426,42	402	198,0	95	76	9,5		
HDB 192 - 8M 85	192	8B	3030	-	488,92	487,54	462	198,0	95	76	9,5		

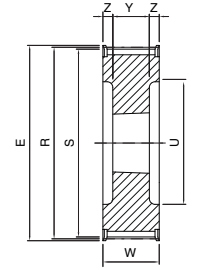

5

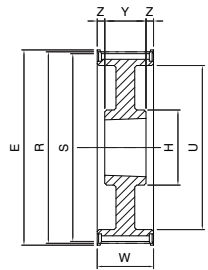

8

HDB ... -14M40

14M

Code	Teeth nr.	Type	SER-SIT® Taper bushing	E [mm]	R [mm]	S [mm]	U [mm]	H [mm]	W [mm]	Y [mm]	Z [mm]	Flange	Material
HDB 28 - 14M 40	28	5	2012	128,0	124,78	122,12	98	-	54	32	11,0	with flanges	steel
HDB 29 - 14M 40	29	5	2012	138,0	129,23	126,57	100	-	54	32	11,0		
HDB 30 - 14M 40	30	5	2012	138,0	133,69	130,99	100	-	54	32	11,0		
HDB 32 - 14M 40	32	5	2012	154,0	142,60	139,88	104	-	54	32	11,0		
HDB 34 - 14M 40	34	5	2517	160,0	151,52	148,79	110	-	54	45	4,5		
HDB 36 - 14M 40	36	5	2517	168,0	160,43	157,68	120	-	54	45	4,5		
HDB 38 - 14M 40	38	5	2517	183,0	169,34	166,60	130	-	54	45	4,5		
HDB 40 - 14M 40	40	5	2517	188,0	178,25	175,49	138	-	54	45	4,5		
HDB 44 - 14M 40	44	5	3020	211,0	196,08	193,28	154	-	54	51	1,5		
HDB 48 - 14M 40	48	5	3020	226,0	213,90	211,11	172	-	54	51	1,5		
HDB 56 - 14M 40	56	8	3020	256,0	249,56	246,76	207	170,0	54	51	1,5		
HDB 64 - 14M 40	64	8	3020	296,0	285,21	282,41	243	170,0	54	51	1,5		
HDB 72 - 14M 40	72	8A	3020	-	320,86	318,06	279	170,0	54	51	1,5		
HDB 80 - 14M 40	80	8B	3020	-	356,51	353,71	315	170,0	54	51	1,5		
HDB 90 - 14M 40	90	8B	3020	-	401,07	398,28	359	170,0	54	51	1,5		
HDB 112 - 14M 40	112	8B	3020	-	499,11	496,32	457	170,0	54	51	1,5		
HDB 144 - 14M 40	144	8B	3020	-	641,71	638,92	600	170,0	54	51	1,5		
HDB 168 - 14M 40	168	8B	3020	-	748,66	745,87	705	160,0	54	51	1,5		
HDB 192 - 14M 40	192	9B	3535	-	855,62	852,82	812	178,0	54	89	35		
HDB 216 - 14M 40	216	9B	3535	-	962,57	959,77	920	178,0	54	89	35		
HDB 264 - 14M 40	264	9B	3535	-	1176,47	1173,67	1133	178,0	54	89	35		

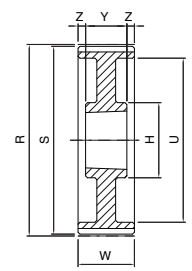

8A

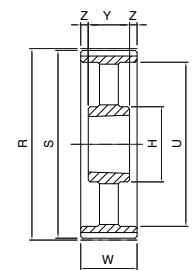

8B

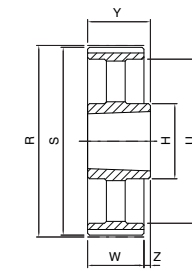

9B

Dimensions of timing pulleys TOP DRIVE® HTD - mounting taper bushing SER-SIT®



HDB ... -14M55

14M

Code	Teeth nr.	Type	SER-SIT® Taper bushing	E [mm]	R [mm]	S [mm]	U [mm]	H [mm]	W [mm]	Y [mm]	Z [mm]	Flange	Material
HDB 28 - 14M 55	28	5	2012	128,0	124,78	122,12	98	-	70	32	19,0	with flanges	steel
HDB 29 - 14M 55	29	5	2012	138,0	129,23	126,57	100	-	70	32	19,0		
HDB 30 - 14M 55	30	5	2517	138,0	133,69	130,99	100	-	70	45	12,5		
HDB 32 - 14M 55	32	5	2517	154,0	142,60	139,88	104	-	70	45	12,5		
HDB 34 - 14M 55	34	5	2517	160,0	151,52	148,79	110	-	70	45	12,5		
HDB 36 - 14M 55	36	5	2517	168,0	160,43	157,68	120	-	70	45	12,5		
HDB 38 - 14M 55	38	5	2517	183,0	169,34	166,60	130	-	70	45	12,5		
HDB 40 - 14M 55	40	5	2517	188,0	178,25	175,49	138	-	70	45	12,5		
HDB 44 - 14M 55	44	5	3020	211,0	196,08	193,28	154	-	70	51	9,5		
HDB 48 - 14M 55	48	5	3020	226,0	213,90	211,11	172	-	70	51	9,5		
HDB 56 - 14M 55	56	8	3020	256,0	249,56	246,76	207	170,0	70	51	9,5		
HDB 64 - 14M 55	64	8	3020	296,0	285,21	282,41	243	170,0	70	51	9,5		
HDB 72 - 14M 55	72	8A	3020	-	320,86	318,06	279	170,0	70	51	9,5		
HDB 80 - 14M 55	80	8B	3020	-	356,51	353,71	314	170,0	70	51	9,5		
HDB 90 - 14M 55	90	8B	3020	-	401,07	398,28	359	170,0	70	51	9,5		
HDB 112 - 14M 55	112	8B	3020	-	499,11	496,32	457	170,0	70	51	9,5		
HDB 144 - 14M 55	144	8B	3020	-	641,71	638,92	600	170,0	70	51	9,5		
HDB 168 - 14M 55	168	8B	3020	-	748,66	745,87	705	160,0	70	51	9,5		
HDB 192 - 14M 55	192	9B	3535	-	855,62	852,82	812	178,0	70	89	19,0		
HDB 216 - 14M 55	216	9B	3535	-	962,57	959,77	920	178,0	70	89	19,0		
HDB 264 - 14M 55	264	9B	3535	-	1176,47	1173,67	1133	178,0	70	89	19,0		

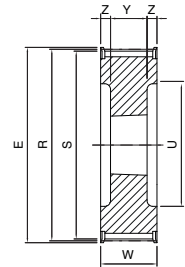

5

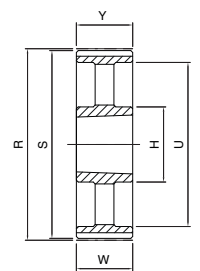

7B

HDB ... -14M85

14M

Code	Teeth nr.	Type	SER-SIT® Taper bushing	E [mm]	R [mm]	S [mm]	U [mm]	H [mm]	W [mm]	Y [mm]	Z [mm]	Flange	Material
HDB 28 - 14M 85	28	5	2517	128,0	124,78	122,12	98	-	102	45	28,5	with flanges	steel
HDB 29 - 14M 85	29	5	2517	138,0	129,23	126,57	100	-	102	45	28,5		
HDB 30 - 14M 85	30	5	2517	138,0	133,69	130,99	100	-	102	45	28,5		
HDB 32 - 14M 85	32	5	2517	154,0	142,60	139,88	104	-	102	45	28,5		
HDB 34 - 14M 85	34	5	2517	160,0	151,52	148,79	110	-	102	45	28,5		
HDB 36 - 14M 85	36	5	3020	168,0	160,43	157,68	120	-	102	51	25,5		
HDB 38 - 14M 85	38	5	3020	183,0	169,34	166,60	130	-	102	51	25,5		
HDB 40 - 14M 85	40	5	3020	188,0	178,25	175,49	138	-	102	51	25,5		
HDB 44 - 14M 85	44	5	3030	211,0	196,08	193,28	154	-	102	76	13,0		
HDB 48 - 14M 85	48	5	3030	226,0	213,90	211,11	172	-	102	76	13,0		
HDB 56 - 14M 85	56	5	3535	256,0	249,56	246,76	207	-	102	89	6,5		
HDB 64 - 14M 85	64	8	3535	296,0	285,21	282,41	243	178,0	102	89	6,5		
HDB 72 - 14M 85	72	8A	3535	-	320,86	318,06	279	178,0	102	89	6,5		
HDB 80 - 14M 85	80	8B	3535	-	356,51	353,71	314	190,0	102	89	6,5		
HDB 90 - 14M 85	90	8B	3535	-	401,07	398,28	359	190,0	102	89	6,5		
HDB 112 - 14M 85	112	8B	3535	-	499,11	496,32	457	178,0	102	89	6,5		
HDB 144 - 14M 85	144	8B	3535	-	641,71	638,92	600	190,0	102	89	6,5		
HDB 168 - 14M 85	168	8B	3535	-	748,66	745,87	705	178,0	102	89	6,5		
HDB 192 - 14M 85	192	7B	4040	-	855,62	852,82	812	215,0	102	102	-		
HDB 216 - 14M 85	216	7B	4040	-	962,57	959,77	920	215,0	102	102	-		
HDB 264 - 14M 85	264	7B	4040	-	1176,47	1173,67	1133	215,0	102	102	-		

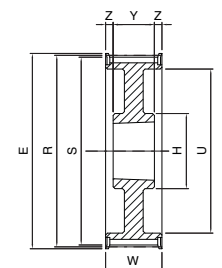

8

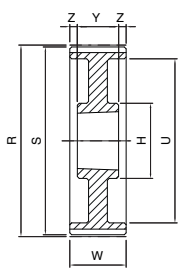

8A

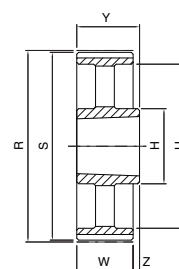

9B

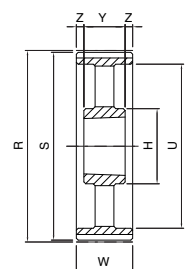

8B

Dimensions of timing pulleys TOP DRIVE® HTD - mounting taper bushing SER-SIT®



HDB ... -14M115

14M

Code	Teeth nr.	Type	SER-SIT® Taper bushing	E [mm]	R [mm]	S [mm]	U [mm]	H [mm]	W [mm]	Y [mm]	Z [mm]	Flange	Material
HDB 28 - 14M 115	28	5	2517	128,0	124,78	122,12	98	-	133	45	44,0	with flanges	steel
HDB 29 - 14M 115	29	5	2517	138,0	129,23	126,57	100	-	133	45	44,0		
HDB 30 - 14M 115	30	5	2517	138,0	133,69	130,99	100	-	133	45	44,0		
HDB 32 - 14M 115	32	5	2517	154,0	142,60	139,88	104	-	133	45	44,0		
HDB 34 - 14M 115	34	5	2517	160,0	151,52	148,79	110	-	133	45	44,0		
HDB 36 - 14M 115	36	5	3020	168,0	160,43	157,68	120	-	133	51	41,0		
HDB 38 - 14M 115	38	5	3020	183,0	169,34	166,60	130	-	133	51	41,0		
HDB 40 - 14M 115	40	5	3020	188,0	178,25	175,49	138	-	133	51	41,0		
HDB 44 - 14M 115	44	5	3030	211,0	196,08	193,28	154	-	133	76	28,5		
HDB 48 - 14M 115	48	5	3030	226,0	213,90	211,11	172	-	133	76	28,5		
HDB 56 - 14M 115	56	5	3535	256,0	249,56	246,76	207	-	133	89	22,0		
HDB 64 - 14M 115	64	8	3535	296,0	285,21	282,41	243	178,0	133	89	22,0		
HDB 72 - 14M 115	72	8A	3535	-	320,86	318,06	279	178,0	133	89	22,0		
HDB 80 - 14M 115	80	8B	3535	-	356,51	353,71	314	178,0	133	89	22,0		
HDB 90 - 14M 115	90	8B	3535	-	401,07	398,28	359	178,0	133	89	22,0		
HDB 112 - 14M 115	112	8B	3535	-	499,11	496,32	457	178,0	133	89	22,0		
HDB 144 - 14M 115	144	8B	4040	-	641,71	638,92	600	230,0	133	102	15,5		
HDB 168 - 14M 115	168	8B	4040	-	748,66	745,87	705	215,0	133	102	15,5		
HDB 192 - 14M 115	192	8B	4040	-	855,62	852,82	812	215,0	133	102	15,5		
HDB 216 - 14M 115	216	8B	4040	-	962,57	959,77	920	215,0	133	102	15,5		
HDB 264 - 14M 115	264	8B	5050	-	1176,47	1173,67	1133	267,0	133	127	3,0		
												without flanges	cast iron

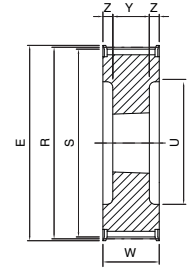

5

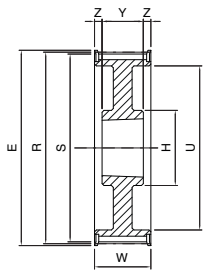

8

HDB ... -14M170

14M

Code	Teeth nr.	Type	SER-SIT® Taper bushing	E [mm]	R [mm]	S [mm]	U [mm]	H [mm]	W [mm]	Y [mm]	Z [mm]	Flange	Material
HDB 38 - 14M 170	38	5	3030	183,0	169,34	166,60	130	-	187	76	55,5	with flanges	steel
HDB 40 - 14M 170	40	5	3030	188,0	178,25	175,49	138	-	187	76	55,5		
HDB 44 - 14M 170	44	5	3535	211,0	196,08	193,28	154	-	187	89	49,0		
HDB 48 - 14M 170	48	5	3535	226,0	213,90	211,11	172	-	187	89	49,0		
HDB 56 - 14M 170	56	5	3535	256,0	249,56	246,76	207	-	187	89	49,0		
HDB 64 - 14M 170	64	5	4040	296,0	285,21	282,41	243	-	187	102	42,5		
HDB 72 - 14M 170	72	8A	4040	-	320,86	318,06	280	230,0	187	102	42,5		
HDB 80 - 14M 170	80	8A	4040	-	356,51	353,71	314	230,0	187	102	42,5		
HDB 90 - 14M 170	90	8B	4040	-	401,07	398,28	359	230,0	187	102	42,5		
HDB 112 - 14M 170	112	8B	5050	-	499,11	496,32	457	265,0	187	127	30,0		
HDB 144 - 14M 170	144	8B	5050	-	641,71	638,92	600	265,0	187	127	30,0		
HDB 168 - 14M 170	168	8B	5050	-	748,66	745,87	705	267,0	187	127	30,0		
HDB 192 - 14M 170	192	8B	5050	-	855,62	852,82	812	267,0	187	127	30,0		
HDB 216 - 14M 170	216	8B	5050	-	962,57	959,77	920	267,0	187	127	30,0		
HDB 264 - 14M 170	264	8B	5050	-	1176,47	1173,67	1133	267,0	187	127	30,0		
												without flanges	cast iron

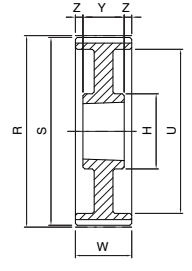

8A

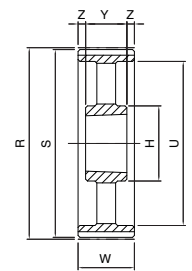

8B

SIT timing pulleys - TOP DRIVE® STD - SUPERTORQUE STPD

STPD pulleys have a different design from the traditional toothed pulleys.

The bottom of the pulley grooves is convex-shaped and the depth of the grooves is smaller than the height of the belt tooth, thus ensuring the effect of "interference" drastically reducing the polygonal effect.

The axial grooves are designed to allow the belt teeth to catch the pulley teeth with negligible friction.

STPD pulleys are available with solid hub and for assembly with SER-SIT® taper bushing

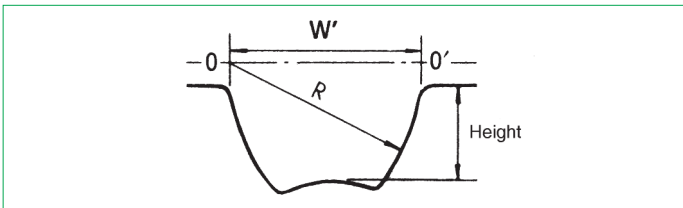

Solid hub

Material: cast iron/steel.

Finishing: protective surface treatment.

Pitch:

- S3M
- S4,5M
- S5M
- S8M
- S14M



For mounting taper bushing SER-SIT®

Material: cast iron.

Finishing: protective surface treatment.

Pitch:

- S8M
- S14M



Special executions

Upon request, SIT is able to design and manufacture any type of pulley based on customer requirements.

For peripheral speed exceeding 33 m/s it is strongly recommended to use steel as material of construction.

$$\text{peripheral speed [m/s]} = \frac{\text{pulley diameter [mm]} \cdot \text{rpm}}{19100}$$

In order to reduce the system weight, the pulleys can be manufactured from light metals; in this case the lifetime will be reduced when compared to the standard because the nylon belt coating has a slightly abrasive effect. This disadvantage can be reduced with a high thickness anodization coating of the teeth

TOLERANCES

Pulley diameter tolerances

External diameter [mm]	Tolerances [mm]
up to 25,4	-0,00 +0,05
from 25,5 to 50,8	-0,00 +0,08
from 50,9 to 101,6	-0,00 +0,10
from 101,7 to 177,8	-0,00 +0,13
from 177,9 to 304,8	-0,00 +0,15
from 304,9 to 508,0	-0,00 +0,18
more than 508,1	-0,00 +0,25

Radial circular runout

External diameter [mm]	Measured total eccentricity [mm]
up to 200	0,13
more than 200	add 0,0005 for any mm more than 200

Cylindricity tolerance

Pulley width	Tolerance
for any 100 mm	0,1 mm without exceeding the external diameter tolerance

Flanged pulleys

Timing belts, when in motion, have a slight lateral displacement. It is therefore necessary to use at least one flanged pulley to prevent the belt jumping out of the pulley.

Usually, in order to reduce the costs, the flanged pulley is the one with the smaller diameter.

In any case, when the distance of the axes is greater than 8 times the diameter of the small pulley, or when the transmission is working on shafts arranged in a position that is not horizontal one, both pulleys have to be flanged.

Protective coating

All (steel and cast iron) pulleys are treated with surface process that gives greater resistance against oxidizing agents. This treatment does not modify the profile or the dimensions of the pulleys.

On request SIT can provide a wide range of special coating, related to the customer specific needs or environmental critical conditions.

Note

Due to a constant improvement of our products, technical data of the pulleys may be subject to changes. For technical and production reasons, in some cases materials other than those indicated in the catalogue may be used. For confirmation of the material actually available, please contact customer service.

Dimensions of timing pulleys TOP DRIVE® STD - solid hub pitches 8M - 14M



TIMING PULLEYS - ST

Part Number	ST 48 S 8M 20
TOP DRIVE® STD timing pulleys - solid hub	
Number of teeth	
Pitch	
Belt width in mm	

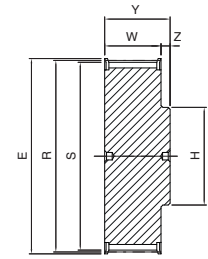

1

ST ... S8M20

8M

Code	Teeth nr.	Type	E [mm]	R [mm]	S [mm]	U [mm]	H [mm]	d [mm]	W [mm]	Y [mm]	Z [mm]	Flange	Material
ST18S8M20	18	1	50,0	45,84	44,46	-	32,0	-	28,0	38,0	10,0	with flanges	steel
ST20S8M20	20	1	55,0	50,93	49,56	-	36,0	-	28,0	38,0	10,0		
ST22S8M20	22	1	62,0	56,02	54,65	-	43,0	-	28,0	38,0	10,0		
ST24S8M20	24	1	67,0	61,12	59,74	-	49,0	-	28,0	38,0	10,0		
ST26S8M20	26	1	73,0	66,21	64,84	-	50,0	-	28,0	38,0	10,0		
ST28S8M20	28	1	77,0	71,30	69,93	-	55,0	-	28,0	38,0	10,0		
ST30S8M20	30	1	84,0	76,39	75,02	-	60,0	-	28,0	38,0	10,0		
ST32S8M20	32	1	88,0	81,49	80,12	-	64,0	-	28,0	38,0	10,0		
ST34S8M20	34	1	94,0	86,58	85,21	-	70,0	-	28,0	38,0	10,0		
ST36S8M20	36	1	98,0	91,67	90,30	-	75,0	-	28,0	38,0	10,0		
ST38S8M20	38	1	104,0	96,77	95,39	-	80,0	-	28,0	38,0	10,0		
ST40S8M20	40	1	108,0	101,86	100,49	-	85,0	-	28,0	38,0	10,0		
ST44S8M20	44	1	121,0	112,05	110,67	-	96,0	-	28,0	38,0	10,0		
ST48S8M20	48	1	129,0	122,23	120,86	-	104,0	-	28,0	38,0	10,0		
ST56S8M20	56	3	149,0	142,60	141,23	117,0	80,0	-	28,0	38,0	10,0		
ST60S8M20	60	3	158,0	152,79	151,42	127,0	80,0	-	28,0	38,0	10,0		
ST64S8M20	64	3	168,0	162,97	161,60	137,0	80,0	-	28,0	38,0	10,0		
ST72S8M20	72	3	191,0	183,35	181,97	158,0	80,0	-	28,0	38,0	10,0		
ST80S8M20	80	3A	-	203,72	202,35	179,0	90,0	-	28,0	38,0	10,0		
ST84S8M20	84	3A	-	213,90	212,53	190,0	90,0	-	28,0	38,0	10,0		
ST90S8M20	90	3A	-	229,18	227,81	204,0	90,0	-	28,0	38,0	10,0		
ST112S8M20	112	5B	-	285,21	283,83	260,0	90,0	19,0	28,0	38,0	10,0		
ST144S8M20	144	5B	-	366,69	365,32	342,0	90,0	19,0	28,0	38,0	10,0		
ST168S8M20	168	5B	-	427,80	426,42	403,0	100,0	19,0	28,0	38,0	10,0		
ST192S8M20	192	5B	-	488,92	487,54	465,0	100,0	19,0	28,0	38,0	10,0		

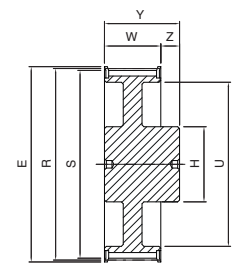

3

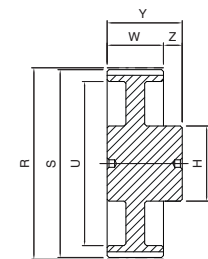

3A

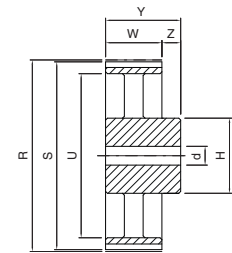

5B

Dimensions of timing pulleys TOP DRIVE® STD - solid hub



ST ... S8M30

8M

Code	Teeth nr.	Type	E [mm]	R [mm]	S [mm]	U [mm]	H [mm]	d [mm]	W [mm]	Y [mm]	Z [mm]	Flange	Material
ST18S8M30	18	1	50,0	45,84	44,46	-	32,0	-	38,0	48,0	10,0	with flanges	steel
ST20S8M30	20	1	55,0	50,93	49,56	-	36,0	-	38,0	48,0	10,0		
ST22S8M30	22	1	62,0	56,02	54,65	-	43,0	-	38,0	48,0	10,0		
ST24S8M30	24	1	67,0	61,12	59,74	-	49,0	-	38,0	48,0	10,0		
ST26S8M30	26	1	73,0	66,21	64,84	-	50,0	-	38,0	48,0	10,0		
ST28S8M30	28	1	77,0	71,30	69,93	-	55,0	-	38,0	48,0	10,0		
ST30S8M30	30	1	84,0	76,39	75,02	-	60,0	-	38,0	48,0	10,0		
ST32S8M30	32	1	88,0	81,49	80,12	-	64,0	-	38,0	48,0	10,0		
ST34S8M30	34	1	94,0	86,58	85,21	-	70,0	-	38,0	48,0	10,0		
ST36S8M30	36	1	98,0	91,67	90,30	-	75,0	-	38,0	48,0	10,0		
ST38S8M30	38	1	104,0	96,77	95,39	-	80,0	-	38,0	48,0	10,0		
ST40S8M30	40	1	108,0	101,86	100,49	-	85,0	-	38,0	48,0	10,0		
ST44S8M30	44	1	121,0	112,05	110,67	-	96,0	-	38,0	48,0	10,0		
ST48S8M30	48	1	129,0	122,23	120,86	-	104,0	-	38,0	48,0	10,0		
ST56S8M30	56	3	149,0	142,60	141,23	117,0	90,0	-	38,0	48,0	10,0		
ST60S8M30	60	3	158,0	152,79	151,42	127,0	90,0	-	38,0	48,0	10,0		
ST64S8M30	64	3	168,0	162,97	161,60	137,0	90,0	-	38,0	48,0	10,0		
ST72S8M30	72	3	191,0	183,35	181,97	158,0	95,0	-	38,0	48,0	10,0		
ST80S8M30	80	3A	-	203,72	202,35	179,0	100,0	-	38,0	48,0	10,0		
ST84S8M30	84	3A	-	213,90	212,53	190,0	100,0	-	38,0	48,0	10,0		
ST90S8M30	90	3A	-	229,18	227,81	204,0	100,0	-	38,0	48,0	10,0		
ST112S8M30	112	5B	-	285,21	283,83	260,0	100,0	19,0	38,0	48,0	10,0		
ST144S8M30	144	5B	-	366,69	365,32	342,0	100,0	19,0	38,0	48,0	10,0		
ST168S8M30	168	5B	-	427,80	426,42	403,0	100,0	19,0	38,0	48,0	10,0		
ST192S8M30	192	5B	-	488,92	487,54	465,0	100,0	19,0	38,0	48,0	10,0		

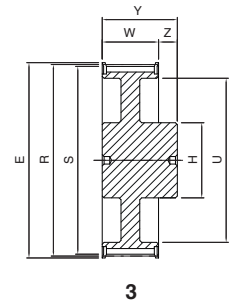
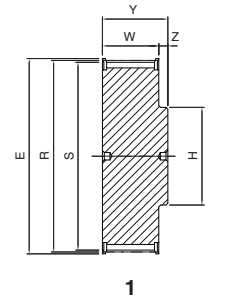

ST ... S8M50

8M

Code	Teeth nr.	Type	E [mm]	R [mm]	S [mm]	U [mm]	H [mm]	d [mm]	W [mm]	Y [mm]	Z [mm]	Flange	Material
ST18S8M50	18	1	50,0	45,84	44,46	-	32,0	-	60,0	70,0	10,0	with flanges	steel
ST20S8M50	20	1	55,0	50,93	49,56	-	36,0	-	60,0	70,0	10,0		
ST22S8M50	22	1	62,0	56,02	54,65	-	43,0	-	60,0	70,0	10,0		
ST24S8M50	24	1	67,0	61,12	59,74	-	49,0	-	60,0	70,0	10,0		
ST26S8M50	26	1	73,0	66,21	64,84	-	50,0	-	60,0	70,0	10,0		
ST28S8M50	28	1	77,0	71,30	69,93	-	55,0	-	60,0	70,0	10,0		
ST30S8M50	30	1	84,0	76,39	75,02	-	60,0	-	60,0	70,0	10,0		
ST32S8M50	32	1	88,0	81,49	80,12	-	64,0	-	60,0	70,0	10,0		
ST34S8M50	34	1	94,0	86,58	85,21	-	70,0	-	60,0	70,0	10,0		
ST36S8M50	36	1	98,0	91,67	90,30	-	75,0	-	60,0	70,0	10,0		
ST38S8M50	38	1	104,0	96,77	95,39	-	80,0	-	60,0	70,0	10,0		
ST40S8M50	40	1	108,0	101,86	100,49	-	85,0	-	60,0	70,0	10,0		
ST44S8M50	44	1	121,0	112,05	110,67	-	96,0	-	60,0	70,0	10,0		
ST48S8M50	48	1	129,0	122,23	120,86	-	104,0	-	60,0	70,0	10,0		
ST56S8M50	56	6	149,0	142,60	141,23	117,0	90,0	-	60,0	60,0	-		
ST60S8M50	60	6	158,0	152,79	151,42	127,0	100,0	-	60,0	60,0	-		
ST64S8M50	64	6	168,0	162,97	161,60	137,0	100,0	-	60,0	60,0	-		
ST72S8M50	72	6	191,0	183,35	181,97	158,0	100,0	-	60,0	60,0	-		
ST80S8M50	80	6A	-	203,72	202,35	179,0	110,0	-	60,0	60,0	-		
ST84S8M50	84	6A	-	213,90	212,53	190,0	110,0	-	60,0	60,0	-		
ST90S8M50	90	6A	-	229,18	227,81	204,0	110,0	-	60,0	60,0	-		
ST112S8M50	112	7B	-	285,21	283,83	260,0	110,0	19,0	60,0	60,0	-		
ST144S8M50	144	7B	-	366,69	365,32	342,0	110,0	19,0	60,0	60,0	-		
ST168S8M50	168	7B	-	427,80	426,42	403,0	120,0	19,0	60,0	60,0	-		
ST192S8M50	192	7B	-	488,92	487,54	465,0	130,0	19,0	60,0	60,0	-		

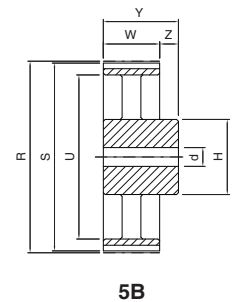
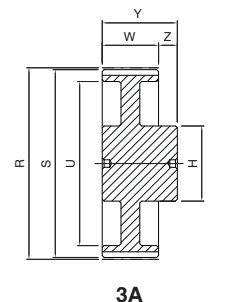

Dimensions of timing pulleys TOP DRIVE® STD - solid hub



TIMING PULLEYS - ST

ST ... S8M85

8M

Code	Teeth nr.	Type	E [mm]	R [mm]	S [mm]	U [mm]	H [mm]	d [mm]	W [mm]	Y [mm]	Z [mm]	Flange	Material
ST22S8M85	22	1	62,0	56,02	54,65	-	43,0	-	95,0	105,0	10,0	with flanges	steel
ST24S8M85	24	1	67,0	61,12	59,74	-	49,0	-	95,0	105,0	10,0		
ST26S8M85	26	1	73,0	66,21	64,84	-	50,0	-	95,0	105,0	10,0		
ST28S8M85	28	1	77,0	71,30	69,93	-	55,0	-	95,0	105,0	10,0		
ST30S8M85	30	1	84,0	76,39	75,02	-	60,0	-	95,0	105,0	10,0		
ST32S8M85	32	1	88,0	81,49	80,12	-	64,0	-	95,0	105,0	10,0		
ST34S8M85	34	1	94,0	86,58	85,21	-	70,0	-	95,0	105,0	10,0		
ST36S8M85	36	1	98,0	91,67	90,30	-	75,0	-	95,0	105,0	10,0		
ST38S8M85	38	1	104,0	96,77	95,39	-	80,0	-	95,0	105,0	10,0		
ST40S8M85	40	1	108,0	101,86	100,49	-	85,0	-	95,0	105,0	10,0		
ST44S8M85	44	1	121,0	112,05	110,67	-	96,0	-	95,0	105,0	10,0		
ST48S8M85	48	1	129,0	122,23	120,86	-	104,0	-	95,0	105,0	10,0		
ST56S8M85	56	1	149,0	142,60	141,23	-	107,0	-	95,0	105,0	10,0		
ST60S8M85	60	1	158,0	152,79	151,42	-	132,0	-	95,0	105,0	10,0		
ST64S8M85	64	6	168,0	162,97	161,60	137,0	100,0	-	95,0	95,0	-		
ST72S8M85	72	6	191,0	183,35	181,97	158,0	110,0	-	95,0	95,0	-		
ST80S8M85	80	6A	-	203,72	202,35	179,0	110,0	-	95,0	95,0	-		
ST84S8M85	84	6A	-	213,90	212,53	190,0	110,0	-	95,0	95,0	-		
ST90S8M85	90	6B	-	229,18	227,81	204,0	110,0	-	95,0	95,0	-		
ST112S8M85	112	7B	-	285,21	283,83	260,0	110,0	19,0	95,0	95,0	-		
ST144S8M85	144	7B	-	366,69	365,32	342,0	120,0	19,0	95,0	95,0	-		
ST168S8M85	168	7B	-	427,80	426,42	403,0	120,0	19,0	95,0	95,0	-		
ST192S8M85	192	7B	-	488,92	487,54	465,0	130,0	19,0	95,0	95,0	-		

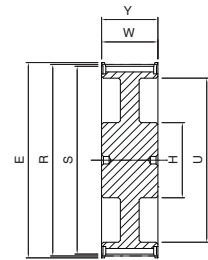

6

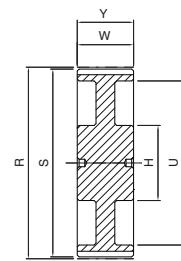

6A

ST ... S14M40

14M

Code	Teeth nr.	Type	E [mm]	R [mm]	S [mm]	U [mm]	H [mm]	d [mm]	W [mm]	Y [mm]	Z [mm]	Flange	Material
ST28S14M40	28	1	134,0	124,78	121,98	-	100,0	-	54,0	69,0	15,0	with flanges	cast iron
ST29S14M40	29	1	134,0	129,23	126,44	-	107,0	-	54,0	69,0	15,0		
ST30S14M40	30	1	142,0	133,69	130,90	-	107,0	-	54,0	69,0	15,0		
ST32S14M40	32	1	150,0	142,60	139,81	-	114,0	-	54,0	69,0	15,0		
ST34S14M40	34	1	158,0	151,51	148,72	-	122,0	-	54,0	69,0	15,0		
ST36S14M40	36	1	166,0	160,43	157,63	-	128,0	-	54,0	69,0	15,0		
ST38S14M40	38	1	177,0	169,34	166,55	-	141,0	-	54,0	69,0	15,0		
ST40S14M40	40	1	186,0	178,25	175,46	-	148,0	-	54,0	69,0	15,0		
ST44S14M40	44	3	209,0	196,08	193,28	154,0	120,0	-	54,0	69,0	15,0		
ST48S14M40	48	3	216,0	213,90	211,11	172,0	135,0	-	54,0	69,0	15,0		
ST56S14M40	56	3	261,0	249,56	246,76	207,0	135,0	-	54,0	69,0	15,0		
ST60S14M40	60	3	274,0	267,38	264,59	225,0	135,0	-	54,0	69,0	15,0		
ST64S14M40	64	3	288,0	285,21	282,41	243,0	135,0	-	54,0	69,0	15,0		
ST72S14M40	72	5B	-	320,86	318,06	279,0	135,0	19,0	54,0	69,0	15,0		
ST80S14M40	80	5B	-	356,51	353,71	314,0	135,0	19,0	54,0	69,0	15,0		
ST84S14M40	84	5B	-	374,33	371,54	332,0	135,0	19,0	54,0	69,0	15,0		
ST90S14M40	90	5B	-	401,07	398,28	359,0	135,0	19,0	54,0	69,0	15,0		
ST112S14M40	112	5B	-	499,11	496,32	457,0	135,0	19,0	54,0	69,0	15,0		
ST144S14M40	144	5B	-	641,71	638,92	600,0	135,0	19,0	54,0	69,0	15,0		

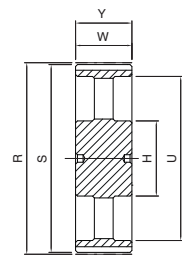

6B

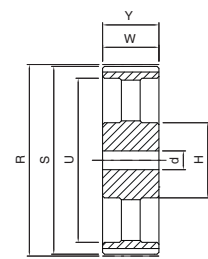

7B

Dimensions of timing pulleys TOP DRIVE® STD - solid hub



ST ... S14M55

14M

Code	Teeth nr.	Type	E [mm]	R [mm]	S [mm]	U [mm]	H [mm]	d [mm]	W [mm]	Y [mm]	Z [mm]	Flange	Material
ST28S14M55	28	1	134,0	124,78	121,98	-	100,0	-	70,0	85,0	15,0	with flanges	cast iron
ST29S14M55	29	1	134,0	129,23	126,44	-	107,0	-	70,0	85,0	15,0		
ST30S14M55	30	1	142,0	133,69	130,90	-	107,0	-	70,0	85,0	15,0		
ST32S14M55	32	1	150,0	142,60	139,81	-	114,0	-	70,0	85,0	15,0		
ST34S14M55	34	1	158,0	151,51	148,72	-	122,0	-	70,0	85,0	15,0		
ST36S14M55	36	1	166,0	160,43	157,63	-	128,0	-	70,0	85,0	15,0		
ST38S14M55	38	1	177,0	169,34	166,55	-	141,0	-	70,0	85,0	15,0		
ST40S14M55	40	1	186,0	178,25	175,46	-	148,0	-	70,0	85,0	15,0		
ST44S14M55	44	3	209,0	196,08	193,28	154,0	120,0	-	70,0	85,0	15,0		
ST48S14M55	48	6	216,0	213,90	211,11	172,0	135,0	-	70,0	70,0	-		
ST56S14M55	56	6	261,0	249,56	246,76	207,0	135,0	-	70,0	70,0	-		
ST60S14M55	60	6	274,0	267,38	264,59	225,0	135,0	-	70,0	70,0	-		
ST64S14M55	64	6	288,0	285,21	282,41	243,0	135,0	-	70,0	70,0	-		
ST72S14M55	72	7B	-	320,86	318,06	279,0	135,0	19,0	70,0	70,0	-		
ST80S14M55	80	7B	-	356,51	353,71	314,0	135,0	19,0	70,0	70,0	-		
ST84S14M55	84	7B	-	374,33	371,54	332,0	135,0	19,0	70,0	70,0	-		
ST90S14M55	90	7B	-	401,07	398,28	359,0	135,0	19,0	70,0	70,0	-		
ST112S14M55	112	7B	-	499,11	496,32	457,0	135,0	19,0	70,0	70,0	-		
ST144S14M55	144	7B	-	641,71	638,92	600,0	135,0	19,0	70,0	70,0	-		

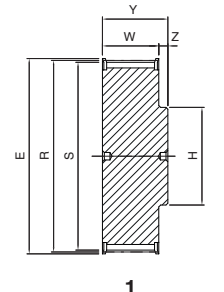

1

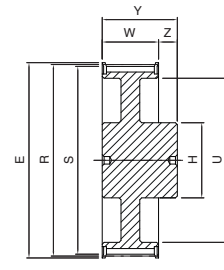

3

ST ... S14M85

14M

Code	Teeth nr.	Type	E [mm]	R [mm]	S [mm]	U [mm]	H [mm]	d [mm]	W [mm]	Y [mm]	Z [mm]	Flange	Material
ST28S14M85	28	1	134,0	124,78	121,98	-	100,0	-	102,0	117,0	15,0	with flanges	cast iron
ST29S14M85	29	1	134,0	129,23	126,44	-	107,0	-	102,0	117,0	15,0		
ST30S14M85	30	1	142,0	133,69	130,90	-	107,0	-	102,0	117,0	15,0		
ST32S14M85	32	1	150,0	142,60	139,81	-	114,0	-	102,0	117,0	15,0		
ST34S14M85	34	1	158,0	151,51	148,72	-	122,0	-	102,0	117,0	15,0		
ST36S14M85	36	1	166,0	160,43	157,63	-	128,0	-	102,0	117,0	15,0		
ST38S14M85	38	1	177,0	169,34	166,55	-	141,0	-	102,0	117,0	15,0		
ST40S14M85	40	1	186,0	178,25	175,46	-	148,0	-	102,0	117,0	15,0		
ST44S14M85	44	1	209,0	196,08	193,28	-	169,0	-	102,0	117,0	15,0		
ST48S14M85	48	1	216,0	213,90	211,11	-	186,0	-	102,0	117,0	15,0		
ST56S14M85	56	6	261,0	249,56	246,76	207,0	150,0	-	102,0	102,0	-		
ST60S14M85	60	6	274,0	267,38	264,59	225,0	150,0	-	102,0	102,0	-		
ST64S14M85	64	6	288,0	285,21	282,41	243,0	150,0	-	102,0	102,0	-		
ST72S14M85	72	7B	-	320,86	318,06	279,0	150,0	19,0	102,0	102,0	-		
ST80S14M85	80	7B	-	356,51	353,71	314,0	150,0	19,0	102,0	102,0	-		
ST84S14M85	84	7B	-	374,33	371,54	332,0	150,0	19,0	102,0	102,0	-		
ST90S14M85	90	7B	-	401,07	398,28	359,0	150,0	19,0	102,0	102,0	-		
ST112S14M85	112	7B	-	499,11	496,32	457,0	150,0	19,0	102,0	102,0	-		
ST144S14M85	144	7B	-	641,71	638,92	600,0	150,0	19,0	102,0	102,0	-		

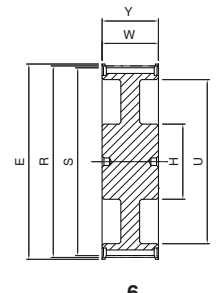

6

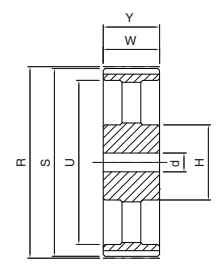

7B

Dimensions of timing pulleys TOP DRIVE® STD - solid hub



TIMING PULLEYS - ST

ST ... S14M115

14M

Code	Teeth nr.	Type	E [mm]	R [mm]	S [mm]	U [mm]	H [mm]	d [mm]	W [mm]	Y [mm]	Z [mm]	Flange	Material	
ST28S14M115	28	1	134,0	124,78	121,98	-	100,0	-	133,0	148,0	15,0	with flanges	cast iron	
ST29S14M115	29	1	134,0	129,23	126,44	-	107,0	-	133,0	148,0	15,0			
ST30S14M115	30	1	142,0	133,69	130,90	-	107,0	-	133,0	148,0	15,0			
ST32S14M115	32	1	150,0	142,60	139,81	-	114,0	-	133,0	148,0	15,0			
ST34S14M115	34	1	158,0	151,51	148,72	-	122,0	-	133,0	148,0	15,0			
ST36S14M115	36	1	166,0	160,43	157,63	-	128,0	-	133,0	148,0	15,0			
ST38S14M115	38	1	177,0	169,34	166,55	-	141,0	-	133,0	148,0	15,0			
ST40S14M115	40	1	186,0	178,25	175,46	-	148,0	-	133,0	148,0	15,0			
ST44S14M115	44	1	209,0	196,08	193,28	-	169,0	-	133,0	148,0	15,0			
ST48S14M115	48	1	216,0	213,90	211,11	-	186,0	-	133,0	148,0	15,0			
ST56S14M115	56	3	261,0	249,56	246,76	207,0	150,0	-	133,0	133,0	-			
ST60S14M115	60	6	274,0	267,38	264,59	225,0	150,0	-	133,0	133,0	-			
ST64S14M115	64	6	288,0	285,21	282,41	243,0	150,0	-	133,0	133,0	-			
ST72S14M115	72	7B	-	320,86	318,06	279,0	150,0	19,0	133,0	133,0	-			
ST80S14M115	80	7B	-	356,51	353,71	314,0	150,0	19,0	133,0	133,0	-			
ST84S14M115	84	7B	-	374,33	371,54	332,0	150,0	19,0	133,0	133,0	-			
ST90S14M115	90	7B	-	401,07	398,28	359,0	150,0	19,0	133,0	133,0	-			
ST112S14M115	112	7B	-	499,11	496,32	457,0	150,0	19,0	133,0	133,0	-			
ST144S14M115	144	7B	-	641,71	638,92	600,0	150,0	19,0	133,0	133,0	-			
												without flanges		

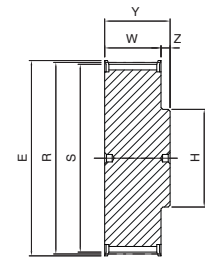

1

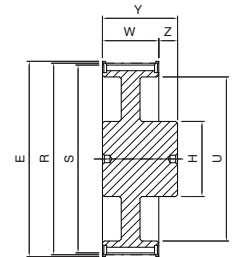

3

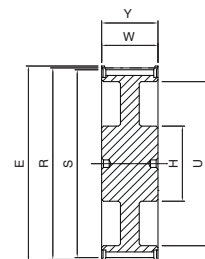

6

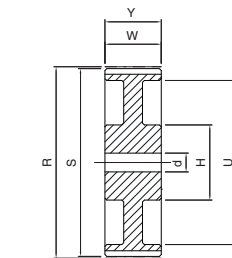

7A

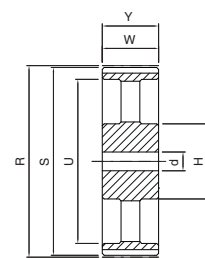

7B

ST ... S14M170

14M

Code	Teeth nr.	Type	E [mm]	R [mm]	S [mm]	U [mm]	H [mm]	d [mm]	W [mm]	Y [mm]	Z [mm]	Flange	Material	
ST28S14M170	28	1	134,0	124,78	121,98	-	100,0	-	187,0	202,0	15,0	with flanges	cast iron	
ST29S14M170	29	1	134,0	129,23	126,44	-	107,0	-	187,0	202,0	15,0			
ST30S14M170	30	1	142,0	133,69	130,90	-	107,0	-	187,0	202,0	15,0			
ST32S14M170	32	1	150,0	142,60	139,81	-	114,0	-	187,0	202,0	15,0			
ST34S14M170	34	1	158,0	151,51	148,72	-	122,0	-	187,0	202,0	15,0			
ST36S14M170	36	1	166,0	160,43	157,63	-	128,0	-	187,0	202,0	15,0			
ST38S14M170	38	1	177,0	169,34	166,55	-	141,0	-	187,0	202,0	15,0			
ST40S14M170	40	1	186,0	178,25	175,46	-	148,0	-	187,0	202,0	15,0			
ST44S14M170	44	1	209,0	196,08	193,28	-	169,0	-	187,0	202,0	15,0			
ST48S14M170	48	1	216,0	213,90	211,11	-	186,0	-	187,0	202,0	15,0			
ST56S14M170	56	3	261,0	249,56	246,76	207,0	160,0	-	187,0	202,0	15,0			
ST60S14M170	60	3	274,0	267,38	264,59	225,0	160,0	-	187,0	202,0	15,0			
ST64S14M170	64	3	288,0	285,21	282,41	243,0	180,0	-	187,0	202,0	15,0			
ST72S14M170	72	7A	-	320,86	318,06	279,0	180,0	19,0	187,0	187,0	-			
ST80S14M170	80	7A	-	356,51	353,71	314,0	180,0	19,0	187,0	187,0	-			
ST84S14M170	84	7B	-	374,33	371,54	332,0	180,0	19,0	187,0	187,0	-			
ST90S14M170	90	7B	-	401,07	398,28	359,0	180,0	19,0	187,0	187,0	-			
ST112S14M170	112	7B	-	499,11	496,32	457,0	200,0	19,0	187,0	187,0	-			
ST144S14M170	144	7B	-	641,71	638,92	600,0	220,0	19,0	187,0	187,0	-			
												without flanges		

Dimensions of timing pulleys TOP DRIVE® STD - mounting taper bushing SER-SIT® itches 8M - 14M



Part Number **STB 32 S 8M 20**

TOP DRIVE® STD pulley - mounting taper bushing

Number of teeth

Pitch

Belt width in mm

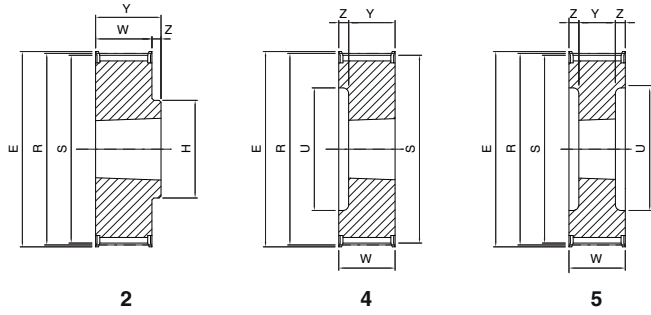

STB ... S8M 20

Code	Teeth nr.	Type	SER-SIT® Taper bushing	E [mm]	R [mm]	S [mm]	U [mm]	H [mm]	W [mm]	Y [mm]	Z [mm]	Flange	Material
STB22S8M20	22	4	1008	62,0	56,02	54,65	38,0	-	28,0	22,0	6,0	with flanges	cast iron
STB24S8M20	24	4	1108	67,0	61,12	59,74	42,0	-	28,0	22,0	6,0		
STB26S8M20	26	4	1108	73,0	66,21	64,84	45,0	-	28,0	22,0	6,0		
STB28S8M20	28	4	1108	77,0	71,30	69,93	52,0	-	28,0	22,0	6,0		
STB30S8M20	30	4	1108	84,0	76,39	75,02	56,0	-	28,0	22,0	6,0		
STB32S8M20	32	4	1610	88,0	81,49	80,12	65,0	-	28,0	25,0	3,0		
STB34S8M20	34	4	1610	94,0	86,58	85,21	66,0	-	28,0	25,0	3,0		
STB36S8M20	36	4	1610	98,0	91,67	90,30	68,0	-	28,0	25,0	3,0		
STB38S8M20	38	4	1610	104,0	96,77	95,39	76,0	-	28,0	25,0	3,0		
STB40S8M20	40	4	1610	108,0	101,86	100,49	80,0	-	28,0	25,0	3,0		
STB44S8M20	44	2	2012	121,0	112,05	110,67	-	99,0	28,0	32,0	4,0		
STB48S8M20	48	2	2012	129,0	122,23	120,86	-	105,0	28,0	32,0	4,0		
STB56S8M20	56	2	2012	149,0	142,60	141,23	-	105,0	28,0	32,0	4,0		
STB64S8M20	64	9	2012	168,0	162,97	161,60	140,0	110,0	28,0	32,0	4,0		
STB72S8M20	72	9	2012	191,0	183,35	181,97	158,0	110,0	28,0	32,0	4,0		
STB80S8M20	80	9A	2012	-	203,72	202,35	178,0	110,0	28,0	32,0	4,0		
STB90S8M20	90	9B	2012	-	229,18	227,81	204,0	110,0	28,0	32,0	4,0		
												without flanges	

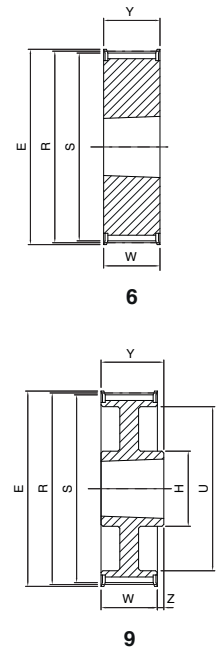

STB ... S8M 30

Code	Teeth nr.	Type	SER-SIT® Taper bushing	E [mm]	R [mm]	S [mm]	U [mm]	H [mm]	W [mm]	Y [mm]	Z [mm]	Flange	Material
STB22S8M30	22	4	1008	62,0	56,02	54,65	38,0	-	38,0	22,0	16,0	with flanges	cast iron
STB24S8M30	24	4	1108	67,0	61,12	59,74	42,0	-	38,0	22,0	16,0		
STB26S8M30	26	4	1108	73,0	66,21	64,84	45,0	-	38,0	22,0	16,0		
STB28S8M30	28	4	1108	77,0	71,30	69,93	52,0	-	38,0	22,0	16,0		
STB30S8M30	30	6	1615	84,0	76,39	75,02	-	-	38,0	38,0	-		
STB32S8M30	32	6	1615	88,0	81,49	80,12	-	-	38,0	38,0	-		
STB34S8M30	34	6	1615	94,0	86,58	85,21	-	-	38,0	38,0	-		
STB36S8M30	36	6	1615	98,0	91,67	90,30	-	-	38,0	38,0	-		
STB38S8M30	38	6	1615	104,0	96,77	95,39	-	-	38,0	38,0	-		
STB40S8M30	40	6	1615	108,0	101,86	100,49	-	-	38,0	38,0	-		
STB44S8M30	44	5	2012	121,0	112,05	110,67	90,0	-	38,0	32,0	-		
STB48S8M30	48	5	2012	129,0	122,23	120,86	98,0	-	38,0	32,0	3,0		
STB56S8M30	56	5	2012	149,0	142,60	141,23	118,0	-	38,0	32,0	3,0		
STB64S8M30	64	9	2517	168,0	162,97	161,6	140,0	120,0	38,0	45,0	3,0		
STB72S8M30	72	9	2517	191,0	183,35	181,97	158,0	120,0	38,0	45,0	7,0		
STB80S8M30	80	9A	2517	-	203,72	202,35	178,0	120,0	38,0	45,0	7,0		
STB90S8M30	90	9B	2517	-	229,18	227,81	204,0	120,0	38,0	45,0	7,0		
STB112S8M30	112	9B	2517	-	285,21	283,83	260,0	120,0	38,0	45,0	7,0		
STB144S8M30	144	9B	2517	-	366,69	365,32	341,0	120,0	38,0	45,0	7,0		
												without flanges	

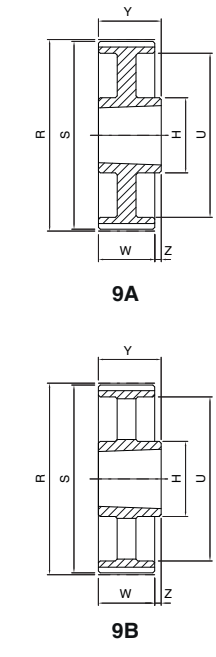

Dimensions of timing pulleys TOP DRIVE® STD - mounting taper bushing SER-SIT®



STB ... S8M 50

8M

Code	Teeth nr.	Type	SER-SIT® Taper bushing	E [mm]	R [mm]	S [mm]	U [mm]	H [mm]	W [mm]	Y [mm]	Z [mm]	Flange	Material	
STB28S8M50	28	5	1108	77,0	71,30	69,93	52,0	-	60,0	22,0	19,0	with flanges	cast iron	
STB30S8M50	30	4	1615	84,0	76,39	75,02	58,0	-	60,0	38,0	22,0			
STB32S8M50	32	4	1615	88,0	81,49	80,12	60,0	-	60,0	38,0	22,0			
STB34S8M50	34	4	1615	94,0	86,58	85,21	66,0	-	60,0	38,0	22,0			
STB36S8M50	36	4	1615	98,0	91,67	90,30	68,0	-	60,0	38,0	22,0			
STB38S8M50	38	4	1615	104,0	96,77	95,39	75,0	-	60,0	38,0	22,0			
STB40S8M50	40	5	2012	108,0	101,86	100,49	80,0	-	60,0	32,0	14,0			
STB44S8M50	44	5	2012	121,0	112,05	110,67	90,0	-	60,0	32,0	14,0			
STB48S8M50	48	5	2012	129,0	122,23	120,86	100,0	-	60,0	32,0	14,0			
STB56S8M50	56	5	2517	149,0	142,60	141,23	120,0	-	60,0	45,0	7,5			
STB64S8M50	64	8	2517	168,0	162,97	161,60	138,0	120,0	60,0	45,0	7,5			
STB72S8M50	72	8	2517	191,0	183,35	181,97	158,0	120,0	60,0	45,0	7,5			
STB80S8M50	80	8A	3020	-	203,72	202,35	178,0	160,0	60,0	51,0	4,5			
STB90S8M50	90	8A	3020	-	229,18	227,81	204,0	160,0	60,0	51,0	4,5			
STB112S8M50	112	8B	3020	-	285,21	283,83	260,0	160,0	60,0	51,0	4,5			
STB144S8M50	144	8B	3020	-	366,69	365,32	341,0	160,0	60,0	51,0	4,5			
STB168S8M50	168	8B	3020	-	427,80	426,42	402,0	160,0	60,0	51,0	4,5			
STB192S8M50	192	8B	3020	-	488,92	487,54	462,0	160,0	60,0	51,0	4,5			
												without flanges		

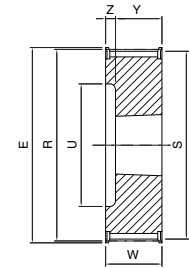

4

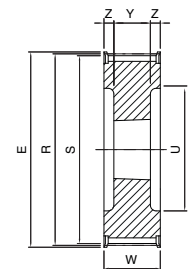

5

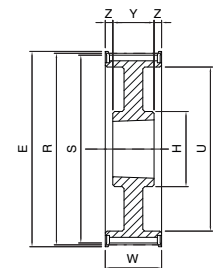

8

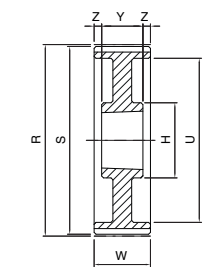

8A

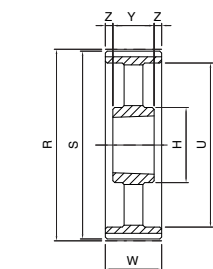

8B

STB ... S8M 85

8M

Code	Teeth nr.	Type	SER-SIT® Taper bushing	E [mm]	R [mm]	S [mm]	U [mm]	H [mm]	W [mm]	Y [mm]	Z [mm]	Flange	Material	
STB34S8M85	34	5	1615	94,0	86,58	85,21	66,0	-	95,0	38,0	28,5	with flanges	cast iron	
STB36S8M85	36	5	1615	98,0	91,67	90,30	68,0	-	95,0	38,0	28,5			
STB38S8M85	38	5	1615	104,0	96,77	95,39	75,0	-	95,0	38,0	28,5			
STB40S8M85	40	5	2012	108,0	101,86	100,49	80,0	-	95,0	32,0	31,5			
STB44S8M85	44	5	2012	121,0	112,05	110,67	90,0	-	95,0	32,0	31,5			
STB48S8M85	48	5	2517	129,0	122,23	120,86	100,0	-	95,0	45,0	25,0			
STB56S8M85	56	5	2517	149,0	142,60	141,23	120,0	-	95,0	45,0	25,0			
STB64S8M85	64	5	2517	168,0	162,97	161,60	138,0	-	95,0	45,0	25,0			
STB72S8M85	72	5	3020	191,0	183,35	181,97	158,0	-	95,0	51,0	22,0			
STB80S8M85	80	8A	3020	-	203,72	202,35	178,0	160,0	95,0	51,0	22,0			
STB90S8M85	90	8A	3020	-	229,18	227,81	204,0	160,0	95,0	51,0	22,0			
STB112S8M85	112	8B	3020	-	285,21	283,83	260,0	160,0	95,0	51,0	22,0			
STB144S8M85	144	8B	3030	-	366,69	365,32	341,0	160,0	95,0	76,0	9,5			
STB168S8M85	168	8B	3030	-	427,80	426,42	402,0	160,0	95,0	76,0	9,5			
STB192S8M85	192	8B	3030	-	488,92	487,54	462,0	160,0	95,0	76,0	9,5			
												without flanges		

Dimensions of timing pulleys TOP DRIVE® STD - mounting taper bushing SER-SIT®



STB ... S14M 40

14M

Code	Teeth nr.	Type	SER-SIT® Taper bushing	E [mm]	R [mm]	S [mm]	U [mm]	H [mm]	W [mm]	Y [mm]	Z [mm]	Flange	Material		
STB28S14M40	28	5	2012	134,0	124,78	121,98	98,0	-	54,0	32,0	11,0	with flanges	cast iron		
STB29S14M40	29	5	2012	134,0	129,23	126,44	100,0	-	54,0	32,0	11,0				
STB30S14M40	30	5	2012	142,0	133,69	130,90	100,0	-	54,0	32,0	11,0				
STB32S14M40	32	5	2012	150,0	142,60	139,81	104,0	-	54,0	32,0	11,0				
STB34S14M40	34	5	2517	158,0	151,51	148,72	110,0	-	54,0	45,0	4,5				
STB36S14M40	36	5	2517	166,0	160,43	157,63	120,0	-	54,0	45,0	4,5				
STB38S14M40	38	5	2517	177,0	169,34	166,55	130,0	-	54,0	45,0	4,5				
STB40S14M40	40	5	2517	186,0	178,25	175,46	138,0	-	54,0	45,0	4,5				
STB44S14M40	44	5	3020	209,0	196,08	193,28	154,0	-	54,0	51,0	1,5				
STB48S14M40	48	5	3020	216,0	213,90	211,11	172,0	-	54,0	51,0	1,5				
STB56S14M40	56	8	3020	261,0	249,56	246,76	207,0	160,0	54,0	51,0	1,5				
STB64S14M40	64	8	3020	288,0	285,21	282,41	243,0	160,0	54,0	51,0	1,5				
STB72S14M40	72	8A	3020	-	320,86	318,06	279,0	160,0	54,0	51,0	1,5			without flanges	cast iron
STB80S14M40	80	8B	3020	-	356,51	353,71	314,0	160,0	54,0	51,0	1,5				
STB90S14M40	90	8B	3020	-	401,07	398,28	359,0	160,0	54,0	51,0	1,5				
STB112S14M40	112	8B	3020	-	499,11	496,32	457,0	160,0	54,0	51,0	1,5				
STB144S14M40	144	8B	3020	-	641,71	638,92	600,0	160,0	54,0	51,0	1,5				

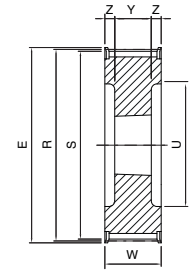

5

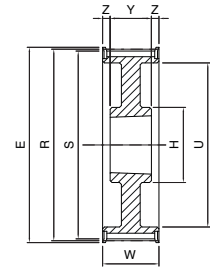

8

STB ... S14M 55

14M

Code	Teeth nr.	Type	SER-SIT® Taper bushing	E [mm]	R [mm]	S [mm]	U [mm]	H [mm]	W [mm]	Y [mm]	Z [mm]	Flange	Material		
STB28S14M55	28	5	2012	134,0	124,78	121,98	98,0	-	70,0	32,0	19,0	with flanges	cast iron		
STB29S14M55	29	5	2012	134,0	129,23	126,44	100,0	-	70,0	32,0	19,0				
STB30S14M55	30	5	2517	142,0	133,69	130,90	100,0	-	70,0	45,0	12,5				
STB32S14M55	32	5	2517	150,0	142,60	139,81	104,0	-	70,0	45,0	12,5				
STB34S14M55	34	5	2517	158,0	151,51	148,72	110,0	-	70,0	45,0	12,5				
STB36S14M55	36	5	2517	166,0	160,43	157,63	120,0	-	70,0	45,0	12,5				
STB38S14M55	38	5	2517	177,0	169,34	166,55	130,0	-	70,0	45,0	12,5				
STB40S14M55	40	5	2517	186,0	178,25	175,46	138,0	-	70,0	45,0	12,5				
STB44S14M55	44	5	3020	209,0	196,08	193,28	154,0	-	70,0	51,0	9,5				
STB48S14M55	48	5	3020	216,0	213,90	211,11	172,0	-	70,0	51,0	9,5				
STB56S14M55	56	8	3020	261,0	249,56	246,76	207,0	160,0	70,0	51,0	9,5				
STB64S14M55	64	8	3020	288,0	285,21	282,41	243,0	160,0	70,0	51,0	9,5				
STB72S14M55	72	8A	3020	-	320,86	318,06	279,0	160,0	70,0	51,0	9,5			without flanges	cast iron
STB80S14M55	80	8B	3020	-	356,51	353,71	314,0	160,0	70,0	51,0	9,5				
STB90S14M55	90	8B	3020	-	401,07	398,28	359,0	160,0	70,0	51,0	9,5				
STB112S14M55	112	8B	3020	-	499,11	496,32	457,0	160,0	70,0	51,0	9,5				
STB144S14M55	144	8B	3020	-	641,71	638,92	600,0	160,0	70,0	51,0	9,5				

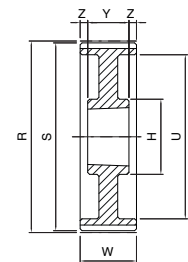

8A

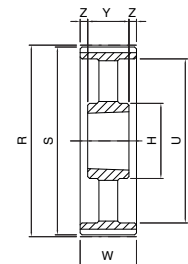

8B

Dimensions of timing pulleys TOP DRIVE® STD - mounting taper bushing SER-SIT®



TIMING PULLEYS - STB

STB ... S14M 85

14M

Code	Teeth nr.	Type	SER-SIT® Taper bushing	E [mm]	R [mm]	S [mm]	U [mm]	H [mm]	W [mm]	Y [mm]	Z [mm]	Flange	Material
STB28S14M85	28	5	2517	134,0	124,78	121,98	98,0	-	102,0	45,0	28,5	with flanges	cast iron
STB29S14M85	29	5	2517	134,0	129,23	126,44	100,0	-	102,0	45,0	28,5		
STB30S14M85	30	5	2517	142,0	133,69	130,90	100,0	-	102,0	45,0	28,5		
STB32S14M85	32	5	2517	150,0	142,60	139,81	104,0	-	102,0	45,0	28,5		
STB34S14M85	34	5	2517	158,0	151,51	148,72	110,0	-	102,0	45,0	28,5		
STB36S14M85	36	5	3020	166,0	160,43	157,63	120,0	-	102,0	51,0	25,5		
STB38S14M85	38	5	3020	177,0	169,34	166,55	130,0	-	102,0	51,0	25,5		
STB40S14M85	40	5	3020	186,0	178,25	175,46	138,0	-	102,0	51,0	25,5		
STB44S14M85	44	5	3030	209,0	196,08	193,28	154,0	-	102,0	76,0	13,0		
STB48S14M85	48	5	3030	216,0	213,90	211,11	172,0	-	102,0	76,0	13,0		
STB56S14M85	56	5	3535	261,0	249,56	246,76	207,0	-	102,0	89,0	6,5		
STB64S14M85	64	8	3535	288,0	285,21	282,41	243,0	178,0	102,0	89,0	6,5		
STB72S14M85	72	8A	3535	-	320,86	318,06	279,0	178,0	102,0	89,0	6,5		
STB80S14M85	80	8B	3535	-	356,51	353,71	314,0	178,0	102,0	89,0	6,5		
STB90S14M85	90	8B	3535	-	401,07	398,28	359,0	178,0	102,0	89,0	6,5		
STB112S14M85	112	8B	3535	-	499,11	496,32	457,0	178,0	102,0	89,0	6,5		
STB144S14M85	144	8B	3535	-	641,71	638,92	600,0	178,0	102,0	89,0	6,5		
												without flanges	

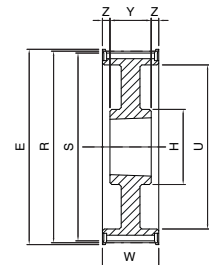
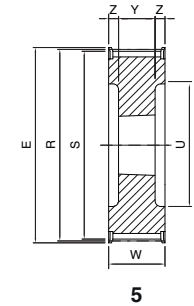

STB ... S14M 115

14M

Code	Teeth nr.	Type	SER-SIT® Taper bushing	E [mm]	R [mm]	S [mm]	U [mm]	H [mm]	W [mm]	Y [mm]	Z [mm]	Flange	Material
STB28S14M115	28	5	2517	134,0	124,78	121,98	98,0	-	133,0	45,0	44,0	with flanges	cast iron
STB29S14M115	29	5	2517	134,0	129,23	126,44	100,0	-	133,0	45,0	44,0		
STB30S14M115	30	5	2517	142,0	133,69	130,90	100,0	-	133,0	45,0	44,0		
STB32S14M115	32	5	2517	150,0	142,60	139,81	104,0	-	133,0	45,0	44,0		
STB34S14M115	34	5	2517	158,0	151,51	148,72	110,0	-	133,0	45,0	44,0		
STB36S14M115	36	5	3020	166,0	160,43	157,63	120,0	-	133,0	51,0	41,0		
STB38S14M115	38	5	3020	177,0	169,34	166,55	130,0	-	133,0	51,0	41,0		
STB40S14M115	40	5	3020	186,0	178,25	175,46	138,0	-	133,0	51,0	41,0		
STB44S14M115	44	5	3030	209,0	196,08	193,28	154,0	-	133,0	76,0	28,5		
STB48S14M115	48	5	3030	216,0	213,90	211,11	172,0	-	133,0	76,0	28,5		
STB56S14M115	56	5	3535	261,0	249,56	246,76	207,0	-	133,0	89,0	22,0		
STB64S14M115	64	8	3535	288,0	285,21	282,41	243,0	178,0	133,0	89,0	22,0		
STB72S14M115	72	8A	3535	-	320,86	318,06	279,0	178,0	133,0	89,0	22,0		
STB80S14M115	80	8B	3535	-	356,51	353,71	314,0	178,0	133,0	89,0	22,0		
STB90S14M115	90	8B	3535	-	401,07	398,28	359,0	178,0	133,0	89,0	22,0		
STB112S14M115	112	8B	3535	-	499,11	496,32	457,0	178,0	133,0	89,0	22,0		
STB144S14M115	144	8B	4040	-	641,71	638,92	600,0	215,0	133,0	102,0	15,5		
												without flanges	

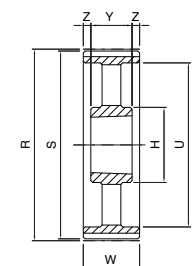
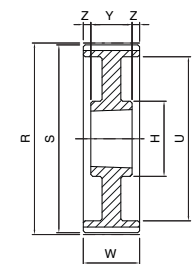

STB ... S14M 170

14M

Code	Teeth nr.	Type	SER-SIT® Taper bushing	E [mm]	R [mm]	S [mm]	U [mm]	H [mm]	W [mm]	Y [mm]	Z [mm]	Flange	Material
STB38S14M170	38	5	3030	177,0	169,34	166,55	130,0	-	187,0	76,0	55,5	with flanges	cast iron
STB40S14M170	40	5	3030	186,0	178,25	175,46	138,0	-	187,0	76,0	55,5		
STB44S14M170	44	5	3535	209,0	196,08	193,28	154,0	-	187,0	89,0	49,0		
STB48S14M170	48	5	3535	216,0	213,90	211,11	172,0	-	187,0	89,0	49,0		
STB56S14M170	56	5	3535	261,0	249,56	246,76	207,0	-	187,0	89,0	49,0		
STB64S14M170	64	5	4040	288,0	285,21	282,41	243,0	-	187,0	102,0	42,5		
STB72S14M170	72	5	4040	-	320,86	318,06	279,0	215,0	187,0	102,0	42,5		
STB80S14M170	80	8A	4040	-	356,51	353,71	314,0	215,0	187,0	102,0	42,5		
STB90S14M170	90	8B	4040	-	401,07	398,28	359,0	215,0	187,0	102,0	42,5		
STB112S14M170	112	8B	5050	-	499,11	496,32	457,0	267,0	187,0	127,0	30,0		
STB144S14M170	144	8B	5050	-	641,71	638,92	600,0	267,0	187,0	127,0	30,0		
												without flanges	

SIT timing pulleys - FALCON GTR

FALCON GTR pulleys produced by SIT have been specifically designed and developed to fit **FALCON Pd®** belts.

Only the use of SIT pulleys ensures optimal lifetime and performance of the transmission systems.

Pulleys **FALCON GTR** are the result of accurate studies and numerous laboratory tests through which we have achieved optimal matching and maximum noise reduction. SIT has a complete range of **FALCON GTR** pulleys designed for assembly with SER-SIT® taper bushing.

For mounting taper bushing SER-SIT®

Material: steel/cast iron/spheroidal cast iron

Finishing: protective surface treatment.

Pitch:

- 8M
- 14M



Special executions

Upon request, SIT is able to design and manufacture any type of pulley based on customer requirements.

For peripheral speed exceeding 33 m/s it is strongly recommended to use steel as material of construction.

$$\text{peripheral speed [m/s]} = \frac{\text{pulley diameter [mm]} \cdot \text{rpm}}{19100}$$

In order to reduce the system weight, the pulleys can be manufactured from light metals; in this case the lifetime will be reduced when compared to the standard because the nylon belt coating has a slightly abrasive effect. This disadvantage can be reduced with a high thickness anodization coating of the teeth.

Flanged pulleys

Timing belts, when in motion, have a slight lateral displacement. It is therefore necessary to use at least one flanged pulley to prevent the belt jumping out of the pulley.

Usually, in order to reduce the costs, the flanged pulley is the one with the smaller diameter.

In any case, when the distance of the axes is greater than 8 times the diameter of the small pulley, or when the transmission is working on shafts arranged in a position that is not horizontal, both pulleys have to be flanged.

TOLERANCES

Pulley diameter tolerances

External Diameter [mm]	Tolerances [mm]
up to 25,4	-0,00 +0,05
from 25,5 to 50,8	-0,00 +0,08
from 50,9 to 101,6	-0,00 +0,10
from 101,7 to 177,8	-0,00 +0,13
from 177,9 to 304,8	-0,00 +0,15
from 304,9 to 508,0	-0,00 +0,18
more than 508,1	-0,00 +0,25

Radial circular runout

External Diameter [mm]	Measured total eccentricity [mm]
up to 200	0,13
more than 200	add 0,0005 for any mm more than 200

Cylindricity tolerance

Pulley width	Tolerances
for any 100 mm	0,1 mm without exceeding the external diameter tolerance

Protective coating

All (steel and cast iron) pulleys are treated with surface process that gives greater resistance against oxidizing agents. This treatment does not modify the profile or the dimensions of the pulleys.

On request SIT can provide a wide range of special coating, related to the customer specific needs or environmental critical conditions.

Note

Due to a constant improvement of our products, technical data of the pulleys may be subject to changes. For technical and production reasons, in some cases materials other than those indicated in the catalogue may be used. For confirmation of the material actually available, please contact customer service.

Dimensions of timing pulleys FALCON GTR - mounting taper bushing SER-SIT® itches 8M - 14M



Part Number	PBG 34 G 8M 36
FALCON GTR pulley - mounting taper bushing	
Number of teeth	
Pitch	
Belt width in mm	

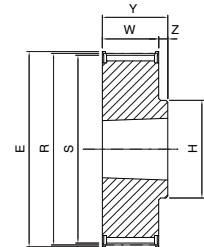

2

PBG ...G8M 12

8M

Code	Teeth nr.	Type	SER-SIT® Taper bushing	E [mm]	R [mm]	S [mm]	U [mm]	H [mm]	W [mm]	Y [mm]	Z [mm]	Material
PBG 22G8M12	22	6	1008	62,0	56,02	54,42	-	-	22,0	22,0	-	cast iron
PBG 24G8M12	24	6	1108	67,0	61,12	59,52	-	-	22,0	22,0	-	
PBG 25G8M12	25	6	1108	67,0	63,66	62,06	-	-	22,0	22,0	-	
PBG 26G8M12	26	6	1108	73,0	66,21	64,61	-	-	22,0	22,0	-	
PBG 27G8M12	27	6	1108	73,0	68,75	67,15	-	-	22,0	22,0	-	
PBG 28G8M12	28	6	1108	77,0	71,30	69,70	-	-	22,0	22,0	-	
PBG 30G8M12	30	6	1108	84,0	76,39	74,79	-	-	22,0	22,0	-	
PBG 31G8M12	31	6	1108	84,0	78,94	77,34	-	-	22,0	22,0	-	
PBG 32G8M12	32	2	1210	88,0	81,49	79,89	-	66,0	20,0	25,0	5,0	steel
PBG 33G8M12	33	2	1610	94,0	84,03	82,43	-	72,0	20,0	25,0	5,0	
PBG 34G8M12	34	2	1610	94,0	86,58	84,98	-	72,0	20,0	25,0	5,0	
PBG 35G8M12	35	2	1610	94,0	89,13	87,53	-	72,0	20,0	25,0	5,0	
PBG 36G8M12	36	2	1610	98,0	91,67	90,07	-	75,0	20,0	25,0	5,0	
PBG 37G8M12	37	2	1610	100,0	94,22	92,62	-	77,0	20,0	25,0	5,0	
PBG 38G8M12	38	2	1610	104,0	96,77	95,17	-	82,0	20,0	25,0	5,0	
PBG 40G8M12	40	2	1610	108,0	101,86	100,26	-	89,0	20,0	25,0	5,0	
PBG 41G8M12	41	2	1610	111,0	104,41	102,81	-	89,0	20,0	25,0	5,0	
PBG 42G8M12	42	2	1610	113,0	106,95	105,35	-	91,0	20,0	25,0	5,0	
PBG 44G8M12	44	2	2012	121,0	112,05	110,45	-	104,0	20,0	32,0	12,0	
PBG 45G8M12	45	2	2012	121,0	114,59	112,99	-	104,0	20,0	32,0	12,0	
PBG 48G8M12	48	2	2012	129,0	122,23	120,63	-	105,0	20,0	32,0	12,0	
PBG 50G8M12	50	2	2012	131,0	127,32	125,72	-	105,0	20,0	32,0	12,0	
PBG 53G8M12	53	2	2012	142,0	134,96	133,36	-	105,0	20,0	32,0	12,0	
PBG 56G8M12	56	2	2012	149,0	142,60	141,00	-	105,0	20,0	32,0	12,0	
PBG 60G8M12	60	2	2012	158,0	152,79	151,19	-	110,0	20,0	32,0	12,0	
PBG 64G8M12	64	9	2012	168,0	162,97	161,37	140,0	110,0	20,0	32,0	12,0	
PBG 67G8M12	67	9	2012	175,0	170,6	169,00	147,0	110,0	20,0	32,0	12,0	
PBG 72G8M12	72	9	2012	191,0	183,35	181,75	158,0	110,0	20,0	32,0	12,0	
PBG 75G8M12	75	9	2012	202,0	190,99	189,39	164,0	110,0	20,0	32,0	12,0	
PBG 80G8M12	80	9	2012	216,0	203,72	202,12	178,0	110,0	20,0	32,0	12,0	
PBG 90G8M12	90	9A	2012	-	229,18	227,58	204,0	110,0	20,0	32,0	12,0	

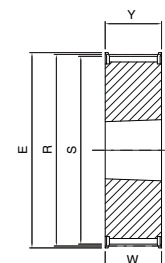

6

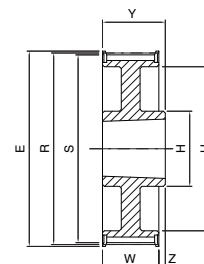

9

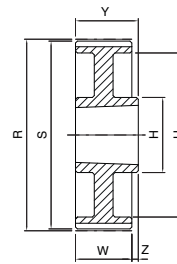

9A

TIMING PULLEYS - PBG

Dimensions of timing pulleys FALCON GTR - mounting taper bushing SER-SIT®



PBG ...G8M 21

8M

Code	Teeth nr.	Type	SER-SIT® Taper bushing	E [mm]	R [mm]	S [mm]	U [mm]	H [mm]	W [mm]	Y [mm]	Z [mm]	Material
PBG 22G8M21	22	4	1008	62,0	56,02	54,42	38,0	-	30,0	22,0	8,0	cast iron
PBG 24G8M21	24	4	1108	67,0	61,12	59,52	42,0	-	30,0	22,0	8,0	
PBG 25G8M21	25	4	1108	67,0	63,66	62,06	45,0	-	30,0	22,0	8,0	
PBG 26G8M21	26	4	1108	73,0	66,21	64,61	45,0	-	30,0	22,0	8,0	
PBG 27G8M21	27	4	1108	73,0	68,75	67,15	45,0	-	30,0	22,0	8,0	
PBG 28G8M21	28	4	1108	77,0	71,30	69,70	52,0	-	30,0	22,0	8,0	
PBG 30G8M21	30	4	1610	84,0	76,39	74,79	58,0	-	30,0	25,0	5,0	steel
PBG 31G8M21	31	4	1610	84,0	78,94	77,34	58,0	-	30,0	25,0	5,0	
PBG 32G8M21	32	4	1610	88,0	81,49	79,89	63,0	-	30,0	25,0	5,0	
PBG 33G8M21	33	4	1610	88,0	84,04	82,44	63,0	-	30,0	25,0	5,0	
PBG 34G8M21	34	4	1610	94,0	86,58	84,98	68,0	-	30,0	25,0	5,0	
PBG 35G8M21	35	4	1610	94,0	89,13	87,53	68,0	-	30,0	25,0	5,0	
PBG 36G8M21	36	4	1610	98,0	91,67	90,07	73,0	-	30,0	25,0	5,0	cast iron
PBG 37G8M21	37	4	1610	100,0	94,22	92,62	75,0	-	30,0	25,0	5,0	
PBG 38G8M21	38	4	1610	104,0	96,77	95,17	78,0	-	30,0	25,0	5,0	
PBG 40G8M21	40	4	1610	108,0	101,86	100,26	83,0	-	30,0	25,0	5,0	
PBG 41G8M21	41	4	1610	108,0	104,41	102,81	83,0	-	30,0	25,0	5,0	
PBG 42G8M21	42	4	1610	111,0	106,70	105,10	86,0	-	30,0	25,0	5,0	
PBG 44G8M21	44	1	2012	121,0	112,05	110,45	-	104,0	30,0	32,0	1,0	
PBG 45G8M21	45	1	2012	121,0	114,59	112,99	-	104,0	30,0	32,0	1,0	
PBG 48G8M21	48	1	2012	129,0	122,23	120,63	-	105,0	30,0	32,0	1,0	
PBG 50G8M21	50	1	2012	131,0	127,32	125,72	-	105,0	30,0	32,0	1,0	
PBG 53G8M21	53	1	2012	142,0	134,96	133,36	-	120,0	30,0	32,0	1,0	
PBG 56G8M21	56	1	2012	149,0	142,60	141,00	-	105,0	30,0	32,0	1,0	
PBG 60G8M21	60	1	2517	158,0	152,79	151,19	-	110,0	30,0	45,0	7,5	
PBG 64G8M21	64	11	2517	168,0	162,97	161,37	138,0	120,0	30,0	45,0	7,5	
PBG 67G8M21	67	11	2517	175,0	170,60	169,00	145,0	120,0	30,0	45,0	7,5	
PBG 72G8M21	72	11	2517	191,0	183,35	181,75	158,0	120,0	30,0	45,0	7,5	
PBG 75G8M21	75	11	2517	202,0	190,99	189,39	165,0	120,0	30,0	45,0	7,5	
PBG 80G8M21	80	11	3020	216,0	203,72	202,12	178,0	160,0	30,0	51,0	10,5	
PBG 90G8M21	90	11A	3020	-	229,18	227,58	204,0	160,0	30,0	51,0	10,5	
PBG 112G8M21	112	11B	3020	-	285,21	283,61	260,0	160,0	30,0	51,0	10,5	
PBG 140G8M21	140	11B	3020	-	356,51	354,91	331,0	160,0	30,0	51,0	10,5	
PBG 144G8M21	144	11B	3020	-	366,69	365,09	341,0	160,0	30,0	51,0	10,5	

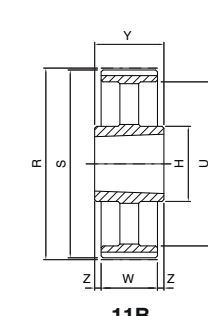
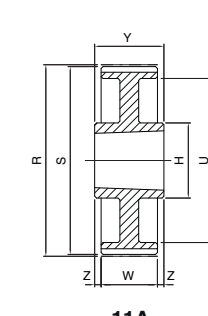
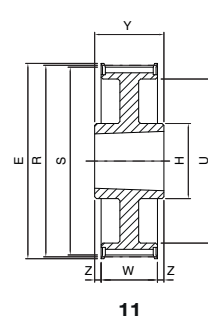
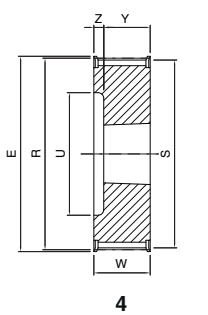
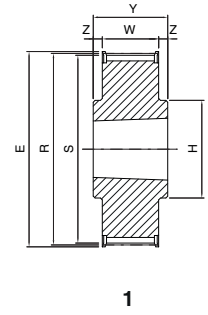

Dimensions of timing pulleys FALCON GTR - mounting taper bushing SER-SIT®



PBG ...G8M 36

8M

Code	Teeth nr.	Type	SER-SIT® Taper bushing	E [mm]	R [mm]	S [mm]	U [mm]	H [mm]	W [mm]	Y [mm]	Z [mm]	Material
PG 25G8M36	25	4C	-	67,0	63,66	62,06	-	49,0	45,0	55,0	10,0	steel
PG 26G8M36	26	4C	-	73,0	66,21	64,61	-	49,0	45,0	55,0	10,0	
PG 27G8M36	27	4C	-	73,0	68,75	67,15	-	49,0	45,0	55,0	10,0	
PG 28G8M36	28	4C	-	77,0	71,30	69,70	-	49,0	45,0	55,0	10,0	
PBG 30G8M36	30	4	1615	84,0	76,39	74,79	58,0	-	45,0	38,0	7,0	steel
PBG 31G8M36	31	4	1615	84,0	78,94	77,34	58,0	-	45,0	38,0	7,0	
PBG 32G8M36	32	4	1615	88,0	81,49	79,89	60,0	-	45,0	38,0	7,0	
PBG 33G8M36	33	4	1615	88,0	84,03	82,43	60,0	-	45,0	38,0	7,0	
PBG 34G8M36	34	4	1615	94,0	86,58	84,98	66,0	-	45,0	38,0	7,0	cast iron
PBG 35G8M36	35	4	1615	94,0	89,13	87,53	66,0	-	45,0	38,0	7,0	
PBG 36G8M36	36	4	1615	98,0	91,67	90,07	68,0	-	45,0	38,0	7,0	
PBG 37G8M36	37	4	1615	100,0	94,22	92,62	70,0	-	45,0	38,0	7,0	
PBG 38G8M36	38	4	1615	104,0	96,77	95,17	75,0	-	45,0	38,0	7,0	steel
PBG 40G8M36	40	5	2012	108,0	101,86	100,26	80,0	-	45,0	32,0	6,5	
PBG 41G8M36	41	5	2012	108,0	104,41	102,81	80,0	-	45,0	32,0	6,5	
PBG 42G8M36	42	5	2012	111,0	106,95	105,35	80,0	-	45,0	32,0	6,5	
PBG 44G8M36	44	5	2012	121,0	112,05	110,45	90,0	-	45,0	32,0	6,5	steel
PBG 45G8M36	45	5	2012	121,0	114,59	112,99	90,0	-	45,0	32,0	6,5	
PBG 48G8M36	48	5	2012	129,0	122,23	120,63	98,0	-	45,0	32,0	6,5	
PBG 50G8M36	50	5	2012	131,0	127,32	125,72	103,0	-	45,0	32,0	6,5	
PBG 53G8M36	53	5	2012	142,0	134,96	133,36	114,0	-	45,0	32,0	6,5	cast iron
PBG 56G8M36	56	6	2517	149,0	142,60	141,00	-	-	45,0	45,0	-	
PBG 60G8M36	60	6	2517	158,0	152,79	151,19	-	-	45,0	45,0	-	
PBG 64G8M36	64	7	2517	168,0	162,97	161,37	138,0	120,0	45,0	45,0	-	
PBG 67G8M36	67	7	2517	175,0	170,60	169,00	145,0	120,0	45,0	45,0	-	cast iron
PBG 72G8M36	72	7	2517	191,0	183,35	181,75	158,0	120,0	45,0	45,0	-	
PBG 75G8M36	75	11	3020	202,0	190,99	189,39	165,0	160,0	45,0	51,0	3,0	
PBG 80G8M36	80	11	3020	216,0	203,72	202,12	178,0	160,0	45,0	51,0	3,0	
PBG 90G8M36	90	11A	3020	-	229,18	227,58	204,0	160,0	45,0	51,0	3,0	cast iron
PBG 112G8M36	112	11B	3020	-	285,21	283,61	260,0	160,0	45,0	51,0	3,0	
PBG 140G8M36	140	11B	3020	-	356,51	354,91	331,0	160,0	45,0	51,0	3,0	
PBG 144G8M36	144	11B	3020	-	366,69	365,09	341,0	160,0	45,0	51,0	3,0	
PBG 168G8M36	168	11B	3020	-	427,81	426,21	402,0	160,0	45,0	51,0	3,0	cast iron
PBG 192G8M36	192	11B	3020	-	488,92	487,32	462,0	160,0	45,0	51,0	3,0	

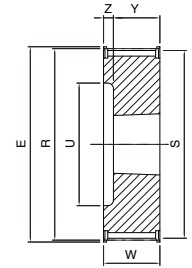

4

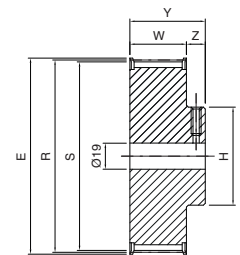

4C
Set screw M10

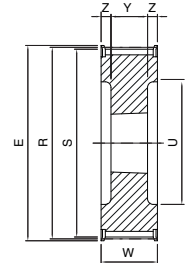

5

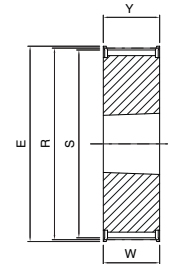

6

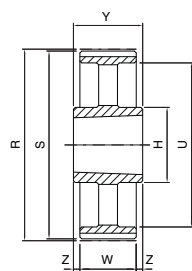

11B

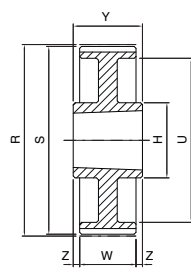

11A

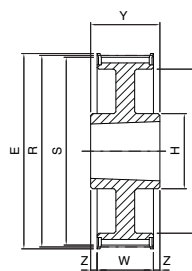

11

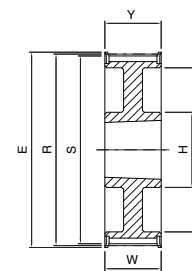

7

Dimensions of timing pulleys FALCON GTR - mounting taper bushing SER-SIT®



PBG ...G8M 62

8M

Code	Teeth nr.	Type	SER-SIT® Taper bushing	E [mm]	R [mm]	S [mm]	U [mm]	H [mm]	W [mm]	Y [mm]	Z [mm]	Material
PBG 30G8M62	30	4	1615	84,0	76,39	74,79	58,0	-	72,0	38,0	34,0	steel
PBG 31G8M62	31	4	1615	88,0	78,94	77,34	60,0	-	72,0	38,0	34,0	
PBG 32G8M62	32	4	1615	88,0	81,49	79,89	60,0	-	72,0	38,0	34,0	
PBG 33G8M62	33	4	1615	90,0	84,04	82,44	62,0	-	72,0	38,0	34,0	
PBG 34G8M62	34	5	1615	94,0	86,58	84,98	66,0	-	72,0	38,0	17,0	cast iron
PBG 35G8M62	35	5	1615	94,0	89,13	87,53	66,0	-	72,0	38,0	17,0	
PBG 36G8M62	36	5	1615	98,0	91,67	90,07	68,0	-	72,0	38,0	17,0	
PBG 37G8M62	37	5	1615	100,0	94,22	92,62	70,0	-	72,0	38,0	17,0	
PBG 38G8M62	38	5	1615	104,0	96,77	95,17	75,0	-	72,0	38,0	17,0	steel
PBG 40G8M62	40	5	2012	108,0	101,86	100,26	80,0	-	72,0	32,0	20,0	
PBG 41G8M62	41	5	2012	108,0	104,41	102,81	80,0	-	72,0	32,0	20,0	
PBG 42G8M62	42	5	2012	111,0	106,95	105,35	80,0	-	72,0	32,0	20,0	
PBG 44G8M62	44	5	2012	121,0	112,05	110,45	90,0	-	72,0	32,0	20,0	cast iron
PBG 45G8M62	45	5	2012	121,0	114,59	112,99	92,0	-	72,0	32,0	20,0	
PBG 48G8M62	48	5	2517	129,0	122,23	120,63	100,0	-	72,0	45,0	13,5	steel
PBG 50G8M62	50	5	2517	131,0	127,32	125,72	105,0	-	72,0	45,0	13,5	
PBG 53G8M62	53	5	2517	142,0	134,96	133,36	116,0	-	72,0	45,0	13,5	
PBG 56G8M62	56	5	2517	149,0	142,60	141,00	120,0	-	72,0	45,0	13,5	
PBG 60G8M62	60	5	2517	158,0	152,79	151,19	128,0	-	72,0	45,0	13,5	cast iron
PBG 64G8M62	64	5	2517	168,0	162,97	161,37	138,0	-	72,0	45,0	13,5	
PBG 67G8M62	67	5	3020	175,0	170,60	169,00	145,0	-	72,0	51,0	10,5	
PBG 72G8M62	72	5	3020	191,0	183,35	181,75	158,0	-	72,0	51,0	10,5	
PBG 75G8M62	75	5	3020	202,0	190,99	189,39	165,0	-	72,0	51,0	10,5	steel
PBG 80G8M62	80	8	3020	216,0	203,72	202,12	178,0	160,0	72,0	51,0	10,5	
PBG 90G8M62	90	8A	3020	-	229,18	227,58	204,0	160,0	72,0	51,0	10,5	
PBG 112G8M62	112	8B	3020	-	285,21	283,61	260,0	160,0	72,0	51,0	10,5	
PBG 140G8M62	140	11B	3030	-	356,51	354,91	331,0	146,0	72,0	76,0	2,0	cast iron
PBG 144G8M62	144	11B	3030	-	366,69	365,09	341,0	146,0	72,0	76,0	2,0	
PBG 168G8M62	168	11B	3030	-	427,81	426,21	402,0	146,0	72,0	76,0	2,0	
PBG 192G8M62	192	11B	3030	-	488,92	487,32	462,0	146,0	72,0	76,0	2,0	

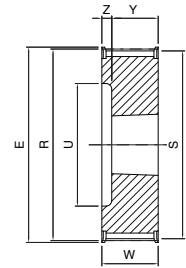

4

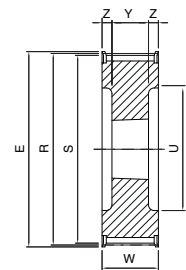

5

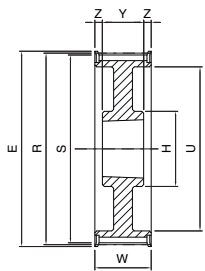

8

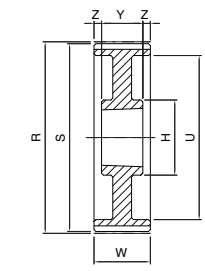

8A

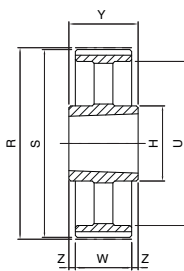

11B

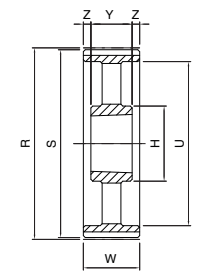

8B

Dimensions of timing pulleys FALCON GTR - mounting taper bushing SER-SIT®



PBG ...G14M 20

14M

Code	Teeth nr.	Type	SER-SIT® Taper bushing	E [mm]	R [mm]	S [mm]	U [mm]	H [mm]	W [mm]	Y [mm]	Z [mm]	Material
PBG 28G14M20	28	3	2012	134,0	124,78	121,98	98,0	-	33,0	32,0	1,0	cast iron
PBG 29G14M20	29	3	2012	134,0	129,23	126,43	100,0	-	33,0	32,0	1,0	
PBG 30G14M20	30	3	2012	142,0	133,69	130,89	100,0	-	33,0	32,0	1,0	
PBG 32G14M20	32	3	2012	150,0	142,60	139,80	104,0	-	33,0	32,0	1,0	
PBG 34G14M20	34	2	2517	158,0	151,52	148,72	-	125,0	33,0	45,0	12,0	
PBG 36G14M20	36	2	2517	166,0	160,43	157,63	-	125,0	33,0	45,0	12,0	
PBG 38G14M20	38	2	2517	177,0	169,34	166,54	-	125,0	33,0	45,0	12,0	
PBG 40G14M20	40	2	2517	186,0	178,25	175,45	-	125,0	33,0	45,0	12,0	
PBG 44G14M20	44	2	3020	209,0	196,08	193,28	-	160,0	33,0	51,0	18,0	
PBG 48G14M20	48	2	3020	216,0	213,90	211,11	-	160,0	33,0	51,0	18,0	
PBG 50G14M20	50	2	3020	232,0	222,82	220,02	-	160,0	33,0	51,0	18,0	
PBG 56G14M20	56	11	3020	261,0	249,55	246,76	207,0	160,0	33,0	51,0	9,0	
PBG 60G14M20	60	11	3020	274,0	267,38	264,58	224,0	160,0	33,0	51,0	9,0	
PBG 64G14M20	64	11	3020	288,0	285,21	282,41	243,0	160,0	33,0	51,0	9,0	
PBG 72G14M20	72	11A	3020	-	320,86	318,06	279,0	160,0	33,0	51,0	9,0	
PBG 80G14M20	80	11B	3020	-	356,51	353,71	314,0	160,0	33,0	51,0	9,0	
PBG 90G14M20	90	11B	3020	-	401,07	398,27	359,0	160,0	33,0	51,0	9,0	
PBG 112G14M20	112	11B	3020	-	499,11	496,31	457,0	160,0	33,0	51,0	9,0	
PBG 140G14M20	140	11B	3020	-	623,89	621,09	581,0	160,0	33,0	51,0	9,0	
PBG 144G14M20	144	11B	3020	-	641,71	638,92	600,0	160,0	33,0	51,0	9,0	
PBG 168G14M20	168	11B	3020	-	748,66	745,87	705,0	160,0	33,0	51,0	9,0	
PBG 192G14M20	192	11B	3535	-	855,62	852,82	812,0	178,0	33,0	89,0	28,0	
PBG 216G14M20	216	11B	3535	-	962,57	959,77	920,0	178,0	33,0	89,0	28,0	
PBG 264G14M20	264	11B	3535	-	1176,47	1173,67	1133,0	178,0	33,0	89,0	28,0	

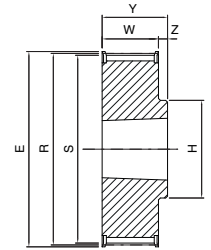

2

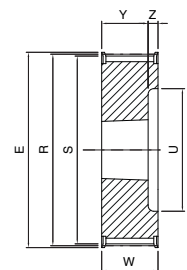

3

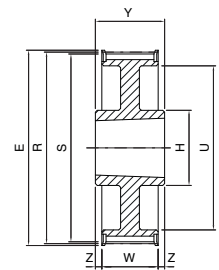

11

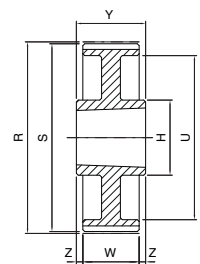

11A

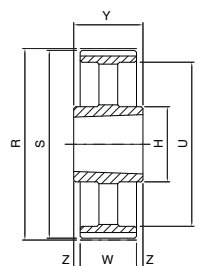

11B

Dimensions of timing pulleys FALCON GTR - mounting taper bushing SER-SIT®



PBG ...G14M 37

14M

Code	Teeth nr.	Type	SER-SIT® Taper bushing	E [mm]	R [mm]	S [mm]	U [mm]	H [mm]	W [mm]	Y [mm]	Z [mm]	Material
PBG 28G14M37	28	5	2012	134,0	124,78	121,98	98,0	-	51,0	32,0	9,5	cast iron
PBG 29G14M37	29	5	2012	134,0	129,23	126,43	100,0	-	51,0	32,0	9,5	
PBG 30G14M37	30	5	2012	142,0	133,69	130,89	100,0	-	51,0	32,0	9,5	
PBG 32G14M37	32	5	2012	150,0	142,60	139,80	104,0	-	51,0	32,0	9,5	
PBG 34G14M37	34	5	2517	158,0	151,52	148,72	110,0	-	51,0	45,0	3,0	
PBG 36G14M37	36	5	2517	166,0	160,43	157,63	120,0	-	51,0	45,0	3,0	
PBG 38G14M37	38	5	2517	177,0	169,34	166,54	130,0	-	51,0	45,0	3,0	
PBG 40G14M37	40	5	2517	186,0	178,25	175,45	138,0	-	51,0	45,0	3,0	
PBG 44G14M37	44	6	3020	209,0	196,08	193,28	-	-	51,0	51,0	-	
PBG 48G14M37	48	6	3020	216,0	213,90	211,11	-	-	51,0	51,0	-	
PBG 50G14M37	50	6	3020	232,0	222,82	220,02	-	-	51,0	51,0	-	
PBG 56G14M37	56	7	3020	261,0	249,55	246,76	207,0	160,0	51,0	51,0	-	
PBG 60G14M37	60	7	3020	274,0	267,38	264,58	224,0	160,0	51,0	51,0	-	
PBG 64G14M37	64	7	3020	288,0	285,21	282,41	243,0	160,0	51,0	51,0	-	
PBG 72G14M37	72	7A	3020	-	320,86	318,06	279,0	160,0	51,0	51,0	-	
PBG 80G14M37	80	7B	3020	-	356,51	353,71	314,0	160,0	51,0	51,0	-	
PBG 90G14M37	90	7B	3020	-	401,07	398,27	359,0	160,0	51,0	51,0	-	
PBG 112G14M37	112	11B	3535	-	499,11	496,31	457,0	178,0	51,0	89,0	19,0	
PBG 140G14M37	140	11B	3535	-	623,89	621,09	581,0	178,0	51,0	89,0	19,0	
PBG 144G14M37	144	11B	3535	-	641,71	638,92	600,0	178,0	51,0	89,0	19,0	
PBG 168G14M37	168	11B	3535	-	748,66	745,87	705,0	178,0	51,0	89,0	19,0	
PBG 192G14M37	192	11B	3535	-	855,62	852,82	812,0	178,0	51,0	89,0	19,0	
PBG 216G14M37	216	11B	4040	-	962,57	959,77	920,0	215,0	51,0	102,0	25,5	
PBG 264G14M37	264	11B	4040	-	1176,47	1173,67	1133,0	215,0	51,0	102,0	25,5	

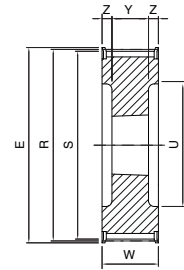

5

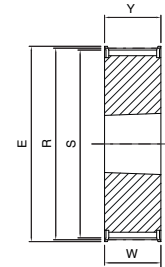

6

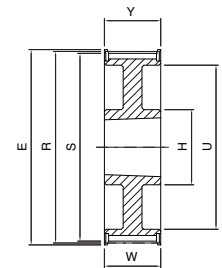

7

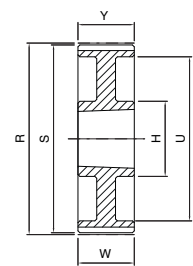

7A

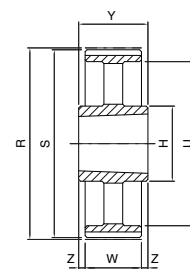

11B

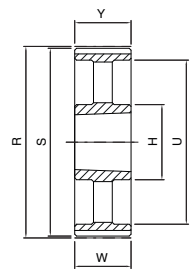

7B

Dimensions of timing pulleys FALCON GTR - mounting taper bushing SER-SIT®



PBG ...G14M 68

14M

Code	Teeth nr.	Type	SER-SIT® Taper bushing	E [mm]	R [mm]	S [mm]	U [mm]	H [mm]	W [mm]	Y [mm]	Z [mm]	Material
PBG 28G14M68	28	5	2517	134,0	124,78	121,98	98,0	-	84,0	45,0	19,5	steel
PBG 29G14M68	29	5	2517	134,0	129,23	126,43	100,0	-	84,0	45,0	19,5	cast iron
PBG 30G14M68	30	5	2517	142,0	133,69	130,89	100,0	-	84,0	45,0	19,5	
PBG 32G14M68*	32	5	2517	150,0	142,60	139,80	104,0	-	84,0	45,0	19,5	
PBG 34G14M68	34	4	3020	158,0	151,52	148,72	110,0	-	84,0	51,0	33,0	GS400
PBG 36G14M68	36	5	3020	166,0	160,43	157,63	120,0	-	84,0	51,0	16,5	cast iron
PBG 38G14M68	38	5	3020	177,0	169,34	166,54	130,0	-	84,0	51,0	16,5	
PBG 40G14M68	40	5	3020	186,0	178,25	175,45	138,0	-	84,0	51,0	16,5	
PBG 44G14M68	44	5	3030	209,0	196,08	193,28	154,0	-	84,0	76,0	4,0	
PBG 48G14M68	48	5	3030	216,0	213,90	211,11	172,0	-	84,0	76,0	4,0	
PBG 50G14M68	50	1	3535	232,0	222,82	220,02	-	178,0	84,0	89,0	2,5	
PBG 56G14M68	56	1	3535	261,0	249,55	246,76	-	178,0	84,0	89,0	2,5	
PBG 60G14M68	60	11	3535	274,0	267,38	264,58	224,0	178,0	84,0	89,0	2,5	
PBG 64G14M68	64	11	3535	288,0	285,21	282,41	243,0	178,0	84,0	89,0	2,5	
PBG 72G14M68	72	11A	3535	-	320,86	318,06	279,0	178,0	84,0	89,0	2,5	
PBG 80G14M68	80	11B	3535	-	356,51	353,71	314,0	178,0	84,0	89,0	2,5	
PBG 90G14M68	90	11B	3535	-	401,07	398,27	359,0	178,0	84,0	89,0	2,5	
PBG 112G14M68	112	11B	3535	-	499,11	496,31	457,0	178,0	84,0	89,0	2,5	
PBG 140G14M68	140	11B	4040	-	623,89	621,09	581,0	215,0	84,0	102,0	9,0	
PBG 144G14M68	144	11B	4040	-	641,71	638,92	600,0	215,0	84,0	102,0	9,0	
PBG 168G14M68	168	11B	4040	-	748,66	745,87	705,0	215,0	84,0	102,0	9,0	
PBG 192G14M68	192	11B	4040	-	855,62	852,82	812,0	215,0	84,0	102,0	9,0	
PBG 216G14M68	216	11B	5050	-	962,57	959,77	920,0	267,0	84,0	127,0	21,5	
PBG 264G14M68	264	11B	5050	-	1176,47	1173,67	1133,0	267,0	84,0	127,0	21,5	

*= New standard

GS400 = spheroidal cast iron

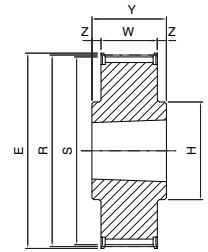

1

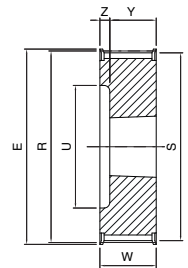

4

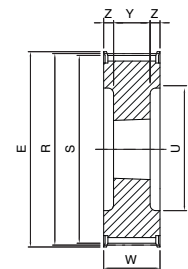

5

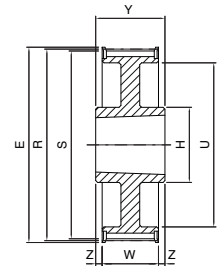

11

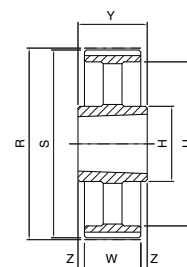

11B

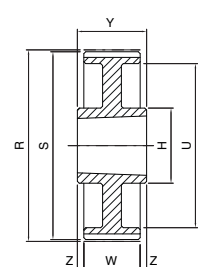

11A

Dimensions of timing pulleys FALCON GTR - mounting taper bushing SER-SIT®



PBG ...G14M 90

14M

Code	Teeth nr.	Type	SER-SIT® Taper bushing	E [mm]	R [mm]	S [mm]	U [mm]	H [mm]	W [mm]	Y [mm]	Z [mm]	Material
PG 28G14M90	28	4C	-	134,0	124,78	121,98	-	100,0	106,0	121,0	15,0	cast iron
PG 29G14M90	29	4C	-	134,0	129,23	126,43	-	100,0	106,0	121,0	15,0	
PG 30G14M90	30	4C	-	142,0	133,69	130,89	-	105,0	106,0	121,0	15,0	
PG 32G14M90*	32	4C	-	150,0	142,60	139,80	-	110,0	106,0	121,0	15,0	
PBG 34G14M90	34	4	3020	158,0	151,52	148,72	110,0	-	106,0	51,0	55,0	GS400
PBG 36G14M90	36	5	3020	166,0	160,43	157,63	120,0	-	106,0	51,0	27,5	cast iron
PBG 38G14M90	38	5	3020	177,0	169,34	166,54	130,0	-	106,0	51,0	27,5	
PBG 40G14M90	40	5	3020	186,0	178,25	175,45	138,0	-	106,0	51,0	27,5	
PBG 44G14M90	44	5	3030	209,0	196,08	193,28	154,0	-	106,0	76,0	15,0	
PBG 48G14M90	48	5	3030	216,0	213,90	211,11	172,0	-	106,0	76,0	15,0	
PBG 50G14M90	50	5	3535	232,0	222,82	220,02	181,0	-	106,0	89,0	8,5	
PBG 56G14M90	56	5	3535	261,0	249,55	246,76	207,0	-	106,0	89,0	8,5	
PBG 60G14M90	60	5	3535	274,0	267,38	264,58	225,0	-	106,0	89,0	8,5	
PBG 64G14M90	64	8	3535	288,0	285,21	282,41	243,0	178,0	106,0	89,0	8,5	
PBG 72G14M90	72	8A	3535	-	320,86	318,06	279,0	178,0	106,0	89,0	8,5	
PBG 80G14M90	80	8B	3535	-	356,51	353,71	314,0	178,0	106,0	89,0	8,5	
PBG 90G14M90	90	8B	3535	-	401,07	398,27	359,0	178,0	106,0	89,0	8,5	
PBG 112G14M90	112	8B	4040	-	499,11	496,31	457,0	215,0	106,0	102,0	2,0	
PBG 140G14M90	140	8B	4040	-	623,89	621,09	582,0	215,0	106,0	102,0	2,0	
PBG 144G14M90	144	8B	4040	-	641,71	638,92	600,0	215,0	106,0	102,0	2,0	
PBG 168G14M90	168	11B	5050	-	748,66	745,87	705,0	267,0	106,0	127,0	10,5	
PBG 192G14M90	192	11B	5050	-	855,62	852,82	812,0	267,0	106,0	127,0	10,5	
PBG 216G14M90	216	11B	5050	-	962,57	959,77	920,0	267,0	106,0	127,0	10,5	
PBG 264G14M90	264	11B	6050	-	1176,47	1173,67	1133,0	395,0	106,0	127,0	10,5	

*= New standard

GS400 = spheroidal cast iron

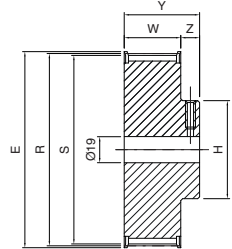

4C
Set screw

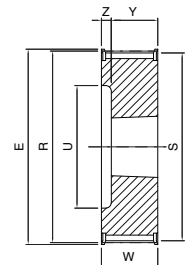

4

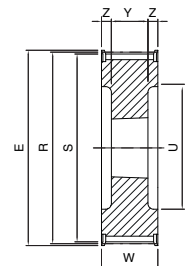

5

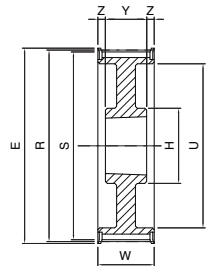

8

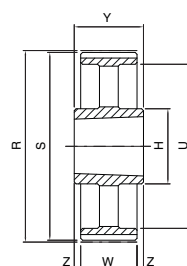

11B

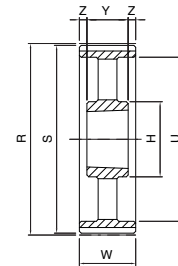

8B

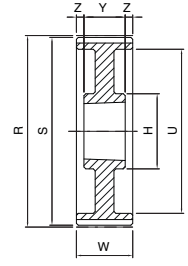

8A

Dimensions of timing pulleys FALCON GTR - mounting taper bushing SER-SIT®



PBG ...G14M 125

14M

Code	Teeth nr.	Type	SER-SIT® Taper bushing	E [mm]	R [mm]	S [mm]	U [mm]	H [mm]	W [mm]	Y [mm]	Z [mm]	Material
PBG 38G14M125	38	4	3535	177,0	169,34	166,54	130,0	-	141,0	89,0	52,0	GS400
PBG 40G14M125	40	4	3535	186,0	178,25	175,45	138,0	-	141,0	89,0	52,0	
PBG 44G14M125	44	5	3535	209,0	196,08	193,28	154,0	-	141,0	89,0	26,0	
PBG 48G14M125	48	5	3535	216,0	213,90	211,11	172,0	-	141,0	89,0	26,0	
PBG 50G14M125	50	5	3535	232,0	222,82	220,02	180,0	-	141,0	89,0	26,0	cast iron
PBG 56G14M125	56	5	3535	261,0	249,55	246,76	207,0	-	141,0	89,0	26,0	
PBG 60G14M125	60	5	4040	274,0	267,38	264,58	224,0	-	141,0	102,0	19,5	
PBG 64G14M125	64	5	4040	288,0	285,21	282,41	243,0	-	141,0	102,0	19,5	
PBG 72G14M125	72	8A	4040	-	320,86	318,06	279,0	215,0	141,0	102,0	19,5	
PBG 80G14M125	80	8A	4040	-	356,51	353,71	314,0	215,0	141,0	102,0	19,5	
PBG 90G14M125	90	8B	4040	-	401,07	398,27	359,0	215,0	141,0	102,0	19,5	
PBG 112G14M125	112	8B	5050	-	499,11	496,31	457,0	267,0	141,0	127,0	7,0	
PBG 140G14M125	140	8B	5050	-	623,89	621,09	581,0	267,0	141,0	127,0	7,0	
PBG 144G14M125	144	8B	5050	-	641,71	638,92	600,0	267,0	141,0	127,0	7,0	
PBG 168G14M125	168	8B	5050	-	748,66	745,87	705,0	267,0	141,0	127,0	7,0	
PBG 192G14M125	192	8B	6050	-	855,62	852,82	812,0	395,0	141,0	127,0	7,0	
PBG 216G14M125	216	8B	6050	-	962,57	959,77	920,0	395,0	141,0	127,0	7,0	
PBG 264G14M125	264	8B	6050	-	1176,47	1173,67	1133,0	395,0	141,0	127,0	7,0	

GS400 = spheroidal cast iron

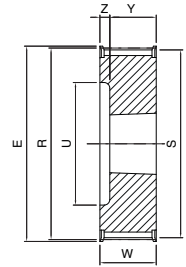

4

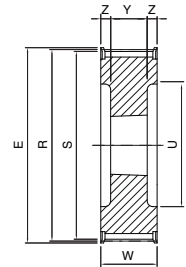

5

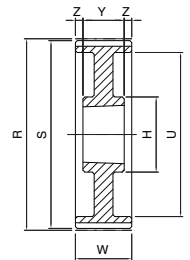

8A

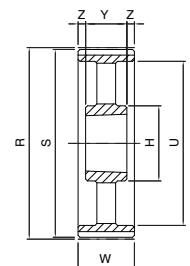

8B

SIT timing pulleys - EAGLE

The SIT **EAGLE** pulleys, manufactured with innovative high-tech equipments, have been specifically designed to fit with the **SILENT SYNC**® belt.

This combination, thanks to the continuous and gradual engagement of the belt with the pulleys, is the best solution existing today in terms of noise abatement, wear reduction and vibration dampening.

The **EAGLE** transmission is the only one that guarantees the self-alignment, even under high load conditions or extreme peripheral speed. For this reason **EAGLE** pulleys don't need flanges; the result is a more compact drive system.

The standard **EAGLE** pulleys are statically balanced.

Solid hub

Material: steel/spheroidal cast iron/cast iron/aluminum.
Finishing: protective surface treatment.

Pitch:

- 5M
- 8M
- 10M
- 14M



For mounting taper bushing SER-SIT®

Material: steel/spheroidal cast iron/cast iron.
Finishing: protective surface treatment.

Pitch:

- 14M

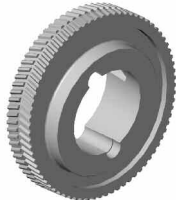

Special executions

Upon request, SIT is able to design and manufacture any type of pulley based on customer requirements.

For peripheral speed exceeding 33 m/s it is strongly recommended to use steel as material of construction.

In case of aluminium execution is possible to reduce the pulley abrasion, due to the nylon belt coating, thanks to a high thickness anodization coating on the pulley teeth (on request).

$$\text{peripheral speed [m/s]} = \frac{\text{pulley diameter [mm]} \cdot \text{rpm}}{19100}$$

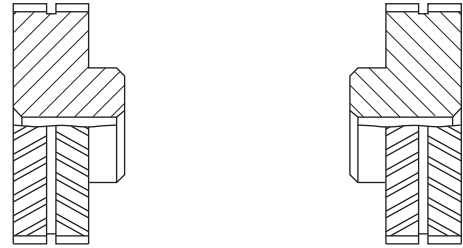

Attention: for non-standard executions, it is important to indicate the orientation of the teeth relative to the position of the hub (as per above pictures).

TOLERANCES

Pulley diameter tolerances

External Diameter [mm]	Tolerances [mm]
up to 101,6	-0,00 +0,13
from 101,7 to 177,8	-0,00 +0,13
from 177,9 to 304,8	-0,00 +0,15
from 304,9 to 508,0	-0,00 +0,18
from 508,1 to 750,0	-0,00 +0,20

Radial circular runout

External Diameter [mm]	Tolerances [mm]
up to 101,6	0,13
from 101,7 to 177,8	0,13
from 177,9 to 304,8	0,15
from 304,9 to 508,0	0,20
from 508,1 to 750,0	0,30

Cylindricity tolerance

Pulley width	Tolerances
for any 100 mm	0,1 mm without exceeding the external diameter tolerance

Protective coating

All (steel and cast iron) pulleys are treated with surface process that gives greater resistance against oxidizing agents. This treatment does not modify the profile or the dimensions of the pulleys.

On request SIT can provide a wide range of special coating, related to the customer specific needs or environmental critical conditions.

Note

Due to a constant improvement of our products, technical data of the pulleys may be subject to changes. For technical and production reasons, in some cases materials other than those indicated in the catalogue may be used. For confirmation of the material actually available, please contact customer service.

Dimensions of timing pulleys EAGLE - solid hub pitches 8M - 14M



Part Number	PE	Y	-32S	-MPB
EAGLE timing pulley - solid hub				
Belt width				
Number of teeth				
Solid hub				

Type "Yellow" Y - belt width W = 16 mm

8M

Code	Teeth nr.	Type	R [mm]	S [mm]	U [mm]	H [mm]	d [mm]	W [mm]	Y [mm]	Z [mm]	Max bore [mm]	Material
PEY-18S-MPB	18	1	45,84	44,47	-	38,4	12,7	17,0	27,0	10,0	26,0	steel
PEY-20S-MPB	20	1	50,93	49,56	-	40,7	12,7	17,0	29,0	12,0	27,0	
PEY-22S-MPB	22	1	56,02	54,65	-	45,9	12,7	17,0	29,0	12,0	31,0	
PEY-24S-MPB	24	1	61,12	59,75	-	51,0	12,7	17,0	33,0	16,0	34,0	
PEY-25S-MPB	25	1	63,66	62,29	-	53,5	12,7	17,0	33,0	16,0	36,0	
PEY-26S-MPB	26	1	66,21	64,84	-	57,8	12,7	17,0	33,0	16,0	39,0	
PEY-28S-MPB	28	1	71,30	69,93	-	61,0	12,7	17,0	33,0	16,0	41,0	
PEY-30S-MPB	30	1	76,40	75,03	-	67,0	12,7	17,0	33,0	16,0	45,0	
PEY-32S-MPB	32	1	81,49	80,12	-	72,0	12,7	17,0	33,0	16,0	48,0	
PEY-34S-MPB	34	1	86,58	85,21	-	77,0	12,7	17,0	33,0	16,0	51,0	
PEY-36S-MPB	36	1	91,68	90,30	-	82,0	12,7	17,0	33,0	16,0	55,0	
PEY-38S-MPB	38	1	96,77	95,40	-	87,0	12,7	17,0	33,0	16,0	58,0	
PEY-40S-MPB	40	1	101,86	100,49	-	92,0	12,7	17,0	33,0	16,0	62,0	
PEY-44S-MPB	44	1	112,05	110,68	-	102,0	12,7	17,0	33,0	16,0	68,0	
PEY-45S-MPB	45	1	114,59	113,22	-	105,0	12,7	17,0	33,0	16,0	70,0	
PEY-48S-MPB	48	1	122,23	120,86	-	112,0	12,7	17,0	33,0	16,0	75,0	
PEY-50S-MPB	50	1	127,33	125,96	-	118,0	12,7	17,0	33,0	16,0	79,0	
PEY-52S-MPB	52	1	132,42	131,05	-	123,0	12,7	17,0	33,0	16,0	82,0	
PEY-56S-MPB	56	1	142,61	141,24	-	133,0	12,7	17,0	33,0	16,0	89,0	
PEY-60S-MPB	60	1	152,79	151,42	-	143,0	12,7	17,0	33,0	16,0	96,0	
PEY-63S-MPB	63	2	160,43	159,06	139,0	110,0	12,7	17,0	33,0	16,0	73,0	GS400
PEY-64S-MPB	64	2	162,98	161,61	142,0	110,0	12,7	17,0	33,0	16,0	74,0	
PEY-68S-MPB	68	2	173,17	171,79	152,0	110,0	12,7	17,0	33,0	16,0	74,0	
PEY-72S-MPB	72	2	183,35	181,98	162,0	110,0	12,7	17,0	33,0	16,0	74,0	
PEY-75S-MPB	75	2	190,99	189,62	170,0	110,0	12,7	17,0	33,0	16,0	73,0	
PEY-76S-MPB	76	2	193,54	192,17	172,0	110,0	12,7	17,0	33,0	16,0	74,0	
PEY-80S-MPB	80	2	203,72	202,35	182,0	110,0	12,7	17,0	33,0	16,0	73,0	GG
PEY-90S-MPB	90	2	229,19	227,82	208,0	110,0	25,4	17,0	33,0	16,0	73,0	
PEY-112S-MPB	112	2	285,21	283,84	264,0	110,0	25,4	17,0	33,0	16,0	73,0	
PEY-140S-MPB	140	2	356,52	355,15	335,0	110,0	25,4	17,0	33,0	16,0	73,0	
PEY-180S-MPB	180	3	458,38	457,01	433,0	150,0	25,4	17,0	33,0	16,0	100,0	
PEY-224S-MPB	224	3	570,43	569,06	545,0	150,0	25,4	17,0	33,0	16,0	100,0	

GS400 = spheroidal cast iron - GG = grey cast iron

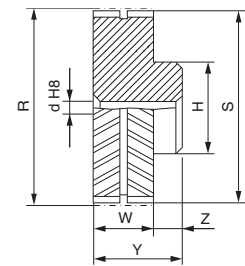

1

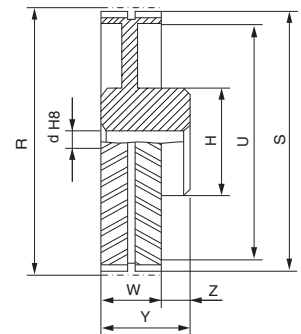

2

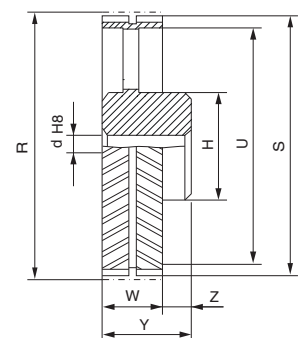

3

Dimensions of timing pulleys EAGLE - solid hub



Type "White" W - belt width $W = 32 \text{ mm}$

8M

Code	Teeth nr.	Type	R [mm]	S [mm]	U [mm]	H [mm]	d [mm]	W [mm]	Y [mm]	Z [mm]	Max bore [mm]	Material
PEW-18S-MPB	18	1	45,84	44,47	-	38,4	12,7	33,0	43,0	10,0	26,0	steel
PEW-20S-MPB	20	1	50,93	49,56	-	40,7	12,7	33,0	45,0	12,0	27,0	
PEW-22S-MPB	22	1	56,02	54,65	-	45,9	12,7	33,0	45,0	12,0	31,0	
PEW-24S-MPB	24	1	61,12	59,75	-	51,0	12,7	33,0	49,0	16,0	34,0	
PEW-25S-MPB	25	1	63,66	62,29	-	53,5	12,7	33,0	49,0	16,0	36,0	
PEW-26S-MPB	26	1	66,21	64,84	-	57,8	12,7	33,0	49,0	16,0	39,0	
PEW-28S-MPB	28	1	71,30	69,93	-	62,0	12,7	33,0	49,0	16,0	41,0	
PEW-30S-MPB	30	1	76,40	75,03	-	67,0	12,7	33,0	49,0	16,0	45,0	
PEW-32S-MPB	32	1	81,49	80,12	-	72,0	12,7	33,0	49,0	16,0	48,0	
PEW-34S-MPB	34	1	86,58	85,21	-	77,0	12,7	33,0	49,0	16,0	51,0	
PEW-36S-MPB	36	1	91,68	90,30	-	82,0	12,7	33,0	49,0	16,0	55,0	
PEW-38S-MPB	38	1	96,77	95,40	-	87,0	12,7	33,0	49,0	16,0	58,0	
PEW-40S-MPB	40	1	101,86	100,49	-	92,0	12,7	33,0	49,0	16,0	62,0	
PEW-44S-MPB	44	1	112,05	110,68	-	102,0	12,7	33,0	49,0	16,0	68,0	
PEW-45S-MPB	45	1	114,59	113,22	-	105,0	12,7	33,0	49,0	16,0	70,0	
PEW-48S-MPB	48	1	122,23	120,86	-	112,0	12,7	33,0	49,0	16,0	75,0	
PEW-50S-MPB	50	1	127,33	125,96	-	118,0	12,7	33,0	49,0	16,0	79,0	
PEW-52S-MPB	52	1	132,42	131,05	-	123,0	12,7	33,0	49,0	16,0	82,0	
PEW-56S-MPB	56	1	142,61	141,24	-	133,0	12,7	33,0	49,0	16,0	89,0	
PEW-60S-MPB	60	1	152,79	151,42	-	143,0	12,7	33,0	49,0	16,0	96,0	
PEW-63S-MPB	63	1	160,43	159,06	-	151,0	12,7	33,0	49,0	16,0	101,0	
PEW-64S-MPB	64	1	162,98	161,61	-	153,0	12,7	33,0	49,0	16,0	102,0	
PEW-68S-MPB	68	2	173,17	171,79	152,0	120,0	25,4	33,0	49,0	16,0	80,0	GS400
PEW-72S-MPB	72	2	183,35	181,98	162,0	120,0	25,4	33,0	49,0	16,0	80,0	
PEW-75S-MPB	75	2	190,99	189,62	170,0	120,0	25,4	33,0	49,0	16,0	80,0	
PEW-76S-MPB	76	2	193,54	192,17	172,0	120,0	25,4	33,0	49,0	16,0	80,0	
PEW-80S-MPB	80	2	203,72	202,35	182,0	120,0	25,4	33,0	49,0	16,0	80,0	
PEW-90S-MPB	90	2	229,19	227,82	208,0	120,0	25,4	33,0	49,0	16,0	80,0	
PEW-112S-MPB	112	2	285,21	283,84	264,0	120,0	25,4	33,0	49,0	16,0	80,0	GG
PEW-140S-MPB	140	2	356,52	355,15	335,0	150,0	25,4	33,0	49,0	16,0	100,0	
PEW-180S-MPB	180	3	458,38	457,00	433,0	150,0	25,4	33,0	49,0	16,0	100,0	
PEW-224S-MPB	224	3	570,43	569,04	545,0	150,0	25,4	33,0	49,0	16,0	100,0	

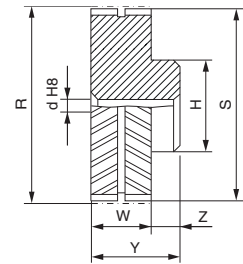

1

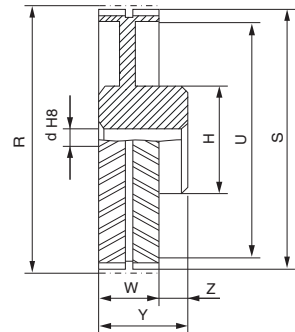

2

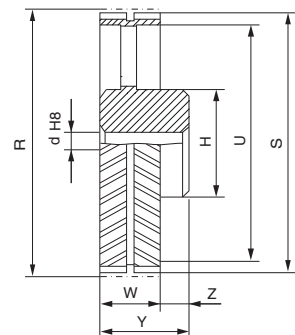

3

GS400 = spheroidal cast iron - GG = grey cast iron

Dimensions of timing pulleys EAGLE - solid hub



Type "Purple" P - belt width $W = 64$ mm

8M

Code	Teeth nr.	Type	R [mm]	S [mm]	U [mm]	H [mm]	d [mm]	W [mm]	Y [mm]	Z [mm]	Max bore [mm]	Material	
PEP-18S-MPB	18	1	45,84	44,47	-	38,4	12,7	65,0	85,0	20,0	26,0	steel	
PEP-20S-MPB	20	1	50,93	49,55	-	40,7	12,7	65,0	85,0	20,0	27,0		
PEP-22S-MPB	22	1	56,02	54,64	-	45,9	12,7	65,0	85,0	20,0	31,0		
PEP-24S-MPB	24	1	61,12	59,74	-	51,0	12,7	65,0	85,0	20,0	34,0		
PE P-25S-MPB	25	1	63,66	62,28	-	53,5	12,7	65,0	85,0	20,0	36,0		
PEP-26S-MPB	26	1	66,21	64,83	-	57,8	12,7	65,0	85,0	20,0	39,0		
PEP-28S-MPB	28	1	71,30	69,92	-	62,0	12,7	65,0	85,0	20,0	41,0		
PEP-30S-MPB	30	1	76,39	75,01	-	67,0	12,7	65,0	85,0	20,0	45,0		
PEP-32S-MPB	32	1	81,49	80,11	-	72,0	12,7	65,0	85,0	20,0	48,0		
PEP-34S-MPB	34	1	86,58	85,20	-	77,0	12,7	65,0	85,0	20,0	51,0		
PEP-36S-MPB	36	1	91,67	90,29	-	82,0	12,7	65,0	85,0	20,0	55,0		
PEP-38S-MPB	38	1	96,77	95,39	-	87,0	12,7	65,0	85,0	20,0	58,0		
PEP-40S-MPB	40	1	101,86	100,48	-	92,0	12,7	65,0	85,0	20,0	62,0		
PEP-44S-MPB	44	1	112,05	110,67	-	102,0	12,7	65,0	85,0	20,0	68,0		
PEP-45S-MPB	45	1	114,59	113,21	-	105,0	12,7	65,0	85,0	20,0	70,0		
PEP-48S-MPB	48	1	122,23	120,85	-	112,0	25,4	65,0	85,0	20,0	75,0		
PEP-50S-MPB	50	1	127,32	125,94	-	118,0	25,4	65,0	85,0	20,0	79,0		
PEP-52S-MPB	52	1	132,42	131,04	-	123,0	25,4	65,0	85,0	20,0	82,0		
PEP-56S-MPB	56	1	142,60	141,22	-	133,0	25,4	65,0	85,0	20,0	89,0		
PEP-60S-MPB	60	1	152,79	151,41	-	143,0	25,4	65,0	85,0	20,0	96,0		
PEP-63S-MPB	63	1	160,43	159,05	-	151,0	25,4	65,0	85,0	20,0	101,0		
PEP-64S-MPB	64	1	162,98	161,60	-	153,0	25,4	65,0	85,0	20,0	102,0		
PEP-68S-MPB	68	2	173,17	171,79	152,0	120,0	25,4	65,0	85,0	20,0	80,0		GS400
PEP-72S-MPB	72	2	183,35	181,97	162,0	120,0	25,4	65,0	85,0	20,0	80,0		
PEP-75S-MPB	75	2	190,99	189,61	170,0	120,0	25,4	65,0	85,0	20,0	80,0		
PEP-76S-MPB	76	2	193,53	192,15	172,0	120,0	25,4	65,0	85,0	20,0	80,0		
PEP-80S-MPB	80	2	203,72	202,34	182,0	120,0	25,4	65,0	85,0	20,0	80,0		
PEP-90S-MPB	90	2	229,18	227,80	208,0	120,0	25,4	65,0	85,0	20,0	80,0		
PEP-112S-MPB	112	2	285,21	283,83	264,0	120,0	25,4	65,0	85,0	20,0	80,0	GG	
PEP-140S-MPB	140	2	356,51	355,14	335,0	150,0	25,4	65,0	85,0	20,0	100,0		
PEP-180S-MPB	180	3	458,37	457,00	433,0	150,0	25,4	65,0	85,0	20,0	100,0		
PEP-224S-MPB	224	3	570,41	569,04	545,0	150,0	25,4	65,0	85,0	20,0	100,0		

GS400 = spheroidal cast iron - GG = grey cast iron

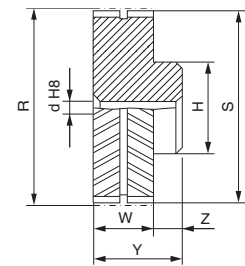

1

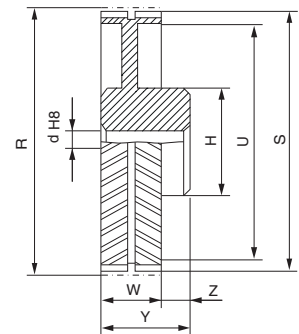

2

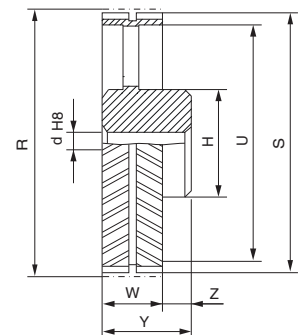

3

Dimensions of timing pulleys EAGLE - solid hub



Type "Blue" B - belt width W = 35 mm

14M

Code	Teeth nr.	Type	R [mm]	S [mm]	U [mm]	H [mm]	d [mm]	W [mm]	Y [mm]	Z [mm]	Max bore [mm]	Material
PEB-28S-MPB	28	1	124,78	121,99	-	105,0	25,4	37,0	53,0	16,0	70,0	steel
PEB-30S-MPB	30	1	133,69	130,90	-	114,0	25,4	37,0	53,0	16,0	76,0	
PEB-32S-MPB	32	1	142,61	139,81	-	123,0	25,4	37,0	53,0	16,0	82,0	
PEB-34S-MPB	34	1	151,52	148,73	-	132,0	25,4	37,0	53,0	16,0	88,0	
PEB-36S-MPB	36	1	160,43	157,64	-	141,0	25,4	37,0	53,0	16,0	94,0	
PEB-38S-MPB	38	1	169,35	166,55	-	150,0	25,4	37,0	53,0	16,0	100,0	
PEB-40S-MPB	40	1	178,26	175,46	-	159,0	25,4	37,0	53,0	16,0	106,0	
PEB-43S-MPB	43	1	191,63	188,83	-	172,0	25,4	37,0	53,0	16,0	115,0	
PEB-45S-MPB	45	1	200,54	197,75	-	181,0	25,4	37,0	53,0	16,0	121,0	
PEB-48S-MPB	48	1	213,91	211,12	-	195,0	25,4	37,0	53,0	16,0	130,0	
PEB-50S-MPB	50	2	222,82	220,03	185,0	150,0	25,4	37,0	53,0	16,0	100,0	GS400
PEB-56S-MPB	56	2	249,56	246,77	212,0	150,0	25,4	37,0	53,0	16,0	100,0	
PEB-60S-MPB	60	2	267,39	264,59	230,0	150,0	25,4	37,0	53,0	16,0	100,0	
PEB-63S-MPB	63	2	280,76	277,96	243,0	150,0	25,4	37,0	53,0	16,0	100,0	
PEB-71S-MPB	71	2	316,41	313,62	279,0	150,0	25,4	37,0	53,0	16,0	100,0	
PEB-75S-MPB	75	2	334,24	331,44	296,0	150,0	25,4	37,0	53,0	16,0	100,0	
PEB-80S-MPB	80	2	356,52	353,72	319,0	150,0	25,4	37,0	53,0	16,0	100,0	
PEB-90S-MPB	90	2	401,08	398,29	358,0	150,0	25,4	37,0	53,0	16,0	100,0	GG
PEB-112S-MPB	112	3	499,12	496,33	456,0	150,0	25,4	37,0	53,0	16,0	100,0	
PEB-140S-MPB	140	3	623,91	621,11	581,0	150,0	25,4	37,0	53,0	16,0	100,0	
PEB-168S-MPB	168	3	748,69	745,89	706,0	150,0	25,4	37,0	53,0	16,0	100,0	

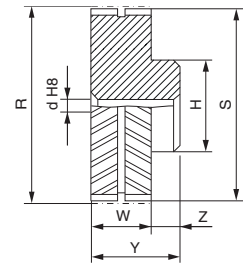

1

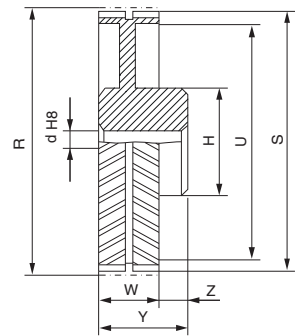

2

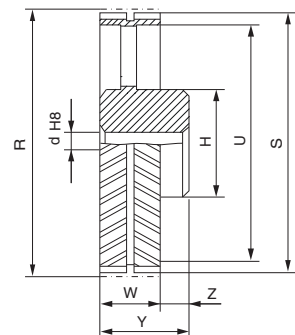

3

Type "Green" G - width W = 52,5 mm

14M

Code	Teeth nr.	Type	R [mm]	S [mm]	U [mm]	H [mm]	d [mm]	W [mm]	Y [mm]	Z [mm]	Max bore [mm]	Material
PEG-28S-MPB	28	1	124,78	121,99	-	109,0	25,4	54,5	74,5	20,0	73,0	steel
PEG-30S-MPB	30	1	133,69	130,90	-	117,5	25,4	54,5	74,5	20,0	78,0	
PEG-32S-MPB	32	1	142,61	139,81	-	126,5	25,4	54,5	74,5	20,0	84,0	
PEG-34S-MPB	34	1	151,52	148,73	-	135,5	25,4	54,5	74,5	20,0	90,0	
PEG-36S-MPB	36	1	160,43	157,64	-	141,0	25,4	54,5	70,5	16,0	94,0	
PEG-38S-MPB	38	1	169,35	166,55	-	150,0	25,4	54,5	70,5	16,0	100,0	
PEG-40S-MPB	40	1	178,26	175,46	-	159,0	25,4	54,5	70,5	16,0	106,0	
PEG-43S-MPB	43	1	191,63	188,83	-	172,0	25,4	54,5	70,5	16,0	115,0	
PEG-45S-MPB	45	1	200,54	197,75	-	181,0	25,4	54,5	70,5	16,0	121,0	
PEG-48S-MPB	48	1	213,91	211,12	-	195,0	25,4	54,5	70,5	16,0	130,0	
PEG-50S-MPB	50	2	222,82	220,03	185,0	150,0	25,4	54,5	70,5	16,0	100,0	GS400
PEG-56S-MPB	56	2	249,56	246,77	212,0	150,0	25,4	54,5	70,5	16,0	100,0	
PEG-60S-MPB	60	2	267,39	264,59	230,0	150,0	25,4	54,5	70,5	16,0	100,0	
PEG-63S-MPB	63	2	280,76	277,96	243,0	150,0	25,4	54,5	70,5	16,0	100,0	
PEG-71S-MPB	71	2	316,41	313,62	279,0	150,0	25,4	54,5	70,5	16,0	100,0	
PEG-75S-MPB	75	2	334,24	331,44	296,0	150,0	25,4	54,5	70,5	16,0	100,0	
PEG-80S-MPB	80	2	356,52	353,72	319,0	150,0	25,4	54,5	70,5	16,0	100,0	
PEG-90S-MPB	90	2	401,08	398,29	358,0	180,0	25,4	54,5	70,5	16,0	120,0	GG
PEG-112S-MPB	112	3	499,12	496,33	456,0	180,0	25,4	54,5	70,5	16,0	120,0	
PEG-140S-MPB	140	3	623,91	621,11	581,0	200,0	25,4	54,5	70,5	16,0	133,0	
PEG-168S-MPB	168	3	748,69	745,89	706,0	200,0	25,4	54,5	70,5	16,0	133,0	

GS400 = spheroidal cast iron - GG = grey cast iron

Dimensions of timing pulleys EAGLE - solid hub



Type "Orange" O - belt width $W = 70$ mm

14M

Code	Teeth nr.	Type	R [mm]	S [mm]	U [mm]	H [mm]	d [mm]	W [mm]	Y [mm]	Z [mm]	Max bore [mm]	Material
PEO-28S-MPB	28	1	124,78	121,99	-	109,0	25,4	72,0	92,0	20,0	73,0	steel
PEO-30S-MPB	30	1	133,69	130,90	-	117,5	25,4	72,0	92,0	20,0	78,0	
PEO-32S-MPB	32	1	142,61	139,81	-	126,5	25,4	72,0	98,0	26,0	84,0	
PEO-34S-MPB	34	1	151,52	148,73	-	135,5	25,4	72,0	98,0	26,0	90,0	
PEO-36S-MPB	36	1	160,43	157,64	-	144,0	25,4	72,0	98,0	26,0	95,0	
PEO-38S-MPB	38	1	169,35	166,55	-	153,0	25,4	72,0	98,0	26,0	101,0	
PEO-40S-MPB	40	1	178,26	175,46	-	162,0	25,4	72,0	98,0	26,0	107,0	
PEO-43S-MPB	43	1	191,63	188,83	-	174,0	25,4	72,0	88,0	16,0	116,0	
PEO-45S-MPB	45	1	200,54	197,75	-	183,0	25,4	72,0	88,0	16,0	122,0	
PEO-48S-MPB	48	1	213,91	211,12	-	197,0	25,4	72,0	88,0	16,0	131,0	
PEO-50S-MPB	50	1	222,82	220,03	-	205,0	25,4	72,0	88,0	16,0	137,0	
PEO-56S-MPB	56	1	249,56	246,77	-	230,0	25,4	72,0	88,0	16,0	153,0	
PEO-60S-MPB	60	2	267,39	264,59	230,0	150,0	25,4	72,0	88,0	16,0	100,0	GS400
PEO-63S-MPB	63	2	280,76	277,96	243,0	150,0	25,4	72,0	88,0	16,0	100,0	
PEO-71S-MPB	71	2	316,41	313,62	279,0	150,0	25,4	72,0	88,0	16,0	100,0	
PEO-75S-MPB	75	2	334,24	331,44	296,0	180,0	25,4	72,0	88,0	16,0	120,0	
PEO-80S-MPB	80	2	356,52	353,72	319,0	180,0	25,4	72,0	88,0	16,0	120,0	
PEO-90S-MPB	90	2	401,08	398,29	358,0	200,0	25,4	72,0	88,0	16,0	133,0	GG
PEO-112S-MPB	112	3	499,12	496,33	456,0	200,0	25,4	72,0	88,0	16,0	133,0	
PEO-140S-MPB	140	3	623,91	621,11	581,0	220,0	25,4	72,0	88,0	16,0	147,0	
PEO-168S-MPB	168	3	748,69	745,89	706,0	220,0	25,4	72,0	88,0	16,0	147,0	

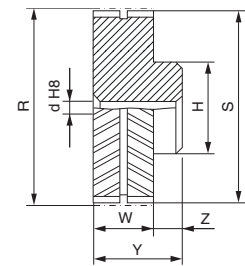

1

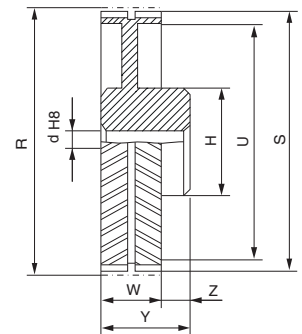

2

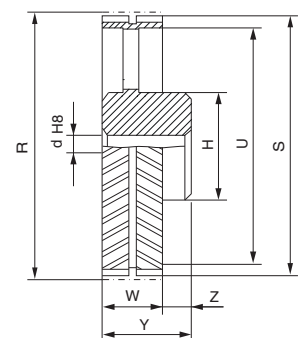

3

Type "Red" R - belt width $W = 105$ mm

14M

Code	Teeth nr.	Type	R [mm]	S [mm]	U [mm]	H [mm]	d [mm]	W [mm]	Y [mm]	Z [mm]	Max bore [mm]	Material
PER-28S-MPB	28	1	124,78	121,99	-	109,0	25,4	107,0	133,0	26,0	73,0	steel
PER-30S-MPB	30	1	133,69	130,90	-	117,5	25,4	107,0	133,0	26,0	78,0	
PER-32S-MPB	32	1	142,61	139,81	-	126,5	25,4	107,0	133,0	26,0	84,0	
PER-34S-MPB	34	1	151,52	148,73	-	135,5	25,4	107,0	133,0	26,0	90,0	
PER-36S-MPB	36	1	160,43	157,64	-	144,0	25,4	107,0	133,0	26,0	96,0	
PER-38S-MPB	38	1	169,35	166,55	-	153,0	25,4	107,0	133,0	26,0	102,0	
PER-40S-MPB	40	1	178,26	175,46	-	162,0	25,4	107,0	133,0	26,0	108,0	
PER-43S-MPB	43	1	191,63	188,83	-	174,0	25,4	107,0	133,0	26,0	117,0	
PER-45S-MPB	45	1	200,54	197,75	-	183,0	25,4	107,0	123,0	16,0	122,0	
PER-48S-MPB	48	1	213,91	211,12	-	197,0	25,4	107,0	123,0	16,0	131,0	
PER-50S-MPB	50	1	222,82	220,03	-	205,0	25,4	107,0	123,0	16,0	137,0	
PER-56S-MPB	56	1	249,56	246,77	-	230,0	25,4	107,0	123,0	16,0	153,0	
PER-60S-MPB	60	2	267,39	264,59	230,0	180,0	25,4	107,0	123,0	16,0	120,0	GS400
PER-63S-MPB	63	2	280,76	277,96	243,0	180,0	25,4	107,0	123,0	16,0	120,0	
PER-71S-MPB	71	2	316,41	313,62	279,0	200,0	25,4	107,0	123,0	16,0	133,0	
PER-75S-MPB	75	2	334,24	331,44	296,0	200,0	25,4	107,0	123,0	16,0	133,0	
PER-80S-MPB	80	2	356,52	353,72	319,0	200,0	25,4	107,0	123,0	16,0	133,0	
PER-90S-MPB	90	2	401,08	398,29	358,0	220,0	25,4	107,0	123,0	16,0	147,0	GG
PER-112S-MPB	112	3	499,12	496,33	456,0	220,0	25,4	107,0	123,0	16,0	147,0	
PER-140S-MPB	140	3	623,91	621,11	581,0	240,0	25,4	107,0	123,0	16,0	160,0	
PER-168S-MPB	168	3	748,69	745,89	706,0	240,0	25,4	107,0	123,0	16,0	160,0	

GS400 = spheroidal cast iron - GG = grey cast iron

Dimensions of timing pulleys EAGLE - mounting taper bushing SER-SIT® passo 14M

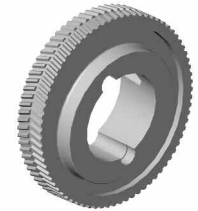

Part Number	PBE	B	-32S	-2517
EAGLE timing pulley - solid hub				
Belt width				
Number of teeth				
Taper bushing size				

Type "Blue" B - belt width W = 35 mm

14M

Code	Teeth nr.	Type	Taper bushing SER-SIT®	R [mm]	S [mm]	U [mm]	H [mm]	W [mm]	Y [mm]	Z [mm]	Material
PBEB-28S-2012	28	4	2012	124,78	121,99	82,0	-	37,0	32,0	5,0	steel
PBEB-30S-2517	30	1	2517	133,69	130,90	-	114,0	37,0	45,0	8,0	
PBEB-32S-2517	32	1	2517	142,61	139,81	-	123,0	37,0	45,0	8,0	
PBEB-34S-2517	34	1	2517	151,52	148,73	-	132,0	37,0	45,0	8,0	
PBEB-36S-3020	36	1	3020	160,43	157,64	-	141,0	37,0	51,0	14,0	
PBEB-38S-3020	38	1	3020	169,35	166,55	-	150,0	37,0	51,0	14,0	
PBEB-40S-3020	40	1	3020	178,26	175,46	-	159,0	37,0	51,0	14,0	
PBEB-43S-3020	43	1	3020	191,63	188,83	-	172,0	37,0	51,0	14,0	
PBEB-45S-3020	45	1	3020	200,54	197,75	-	181,0	37,0	51,0	14,0	
PBEB-48S-3020	48	1	3020	213,91	211,12	-	195,0	37,0	51,0	14,0	
PBEB-50S-3020	50	2	3020	222,82	220,03	180,0	150,0	37,0	51,0	14,0	GS400
PBEB-56S-3020	56	2	3020	249,56	246,77	207,0	150,0	37,0	51,0	14,0	
PBEB-60S-3020	60	2	3020	267,39	264,59	225,0	150,0	37,0	51,0	14,0	
PBEB-63S-3020	63	2	3020	280,76	277,96	238,0	150,0	37,0	51,0	14,0	
PBEB-71S-3020	71	2	3020	316,41	313,62	274,0	150,0	37,0	51,0	14,0	
PBEB-75S-3020	75	2	3020	334,24	331,44	291,0	150,0	37,0	51,0	14,0	
PBEB-80S-3020	80	2	3020	356,52	353,72	314,0	150,0	37,0	51,0	14,0	GG
PBEB-90S-3020	90	2	3020	401,08	398,29	358,0	150,0	37,0	51,0	14,0	
PBEB-112S-3020	112	3	3020	499,12	496,33	456,0	150,0	37,0	51,0	14,0	
PBEB-140S-3020	140	3	3020	623,91	621,11	581,0	150,0	37,0	51,0	14,0	
PBEB-168S-3020	168	3	3020	748,69	745,89	706,0	150,0	37,0	51,0	14,0	

GS400 = spheroidal cast iron - GG = grey cast iron

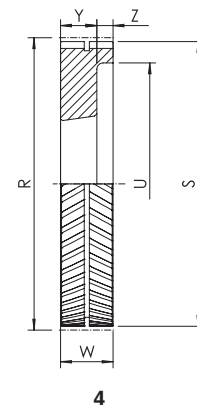
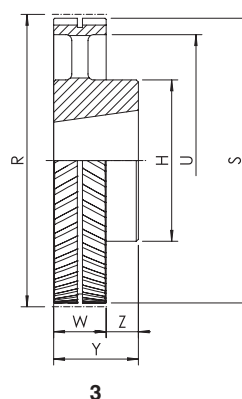
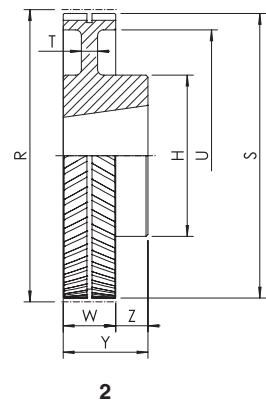
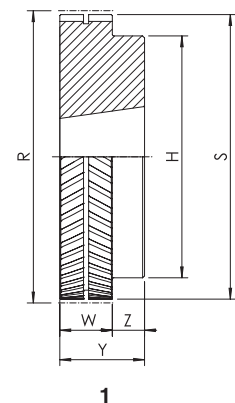

Dimensions of timing pulleys EAGLE - mounting taper bushing SER-SIT®

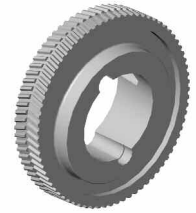

Type "Green" G - belt width $W = 52,5$ mm

14M

Code	Teeth nr.	Type	Taper bushing SER-SIT®	R [mm]	S [mm]	U [mm]	H [mm]	W [mm]	Y [mm]	Z [mm]	Material
PBEG-28S-2517	28	4	2517	124,78	121,99	86,0	-	54,5	45,0	9,5	steel
PBEG-30S-2517	30	4	2517	133,69	130,90	90,0	-	54,5	45,0	9,5	
PBEG-32S-2517	32	4	2517	142,61	139,81	100,0	-	54,5	45,0	9,5	
PBEG-34S-2517	34	4	2517	151,52	148,73	108,0	-	54,5	45,0	9,5	
PBEG-36S-3020	36	4	3020	160,43	157,64	118,0	-	54,5	51,0	3,5	
PBEG-38S-3020	38	4	3020	169,35	166,55	126,0	-	54,5	51,0	3,5	
PBEG-40S-3020	40	4	3020	178,26	175,46	135,0	-	54,5	51,0	3,5	
PBEG-43S-3020	43	4	3020	191,63	188,83	148,0	-	54,5	51,0	3,5	
PBEG-45S-3020	45	4	3020	200,54	197,75	158,0	-	54,5	51,0	3,5	
PBEG-48S-3020	48	4	3020	213,91	211,12	171,0	-	54,5	51,0	3,5	
PBEG-50S-3020	50	8	3020	222,82	220,03	180,0	150,0	54,5	51,0	3,5	GS400
PBEG-56S-3020	56	8	3020	249,56	246,77	207,0	150,0	54,5	51,0	3,5	
PBEG-60S-3020	60	8	3020	267,39	264,59	225,0	150,0	54,5	51,0	3,5	
PBEG-63S-3020	63	8	3020	280,76	277,96	238,0	150,0	54,5	51,0	3,5	
PBEG-71S-3020	71	8	3020	316,41	313,62	274,0	150,0	54,5	51,0	3,5	
PBEG-75S-3020	75	8	3020	334,24	331,44	291,0	150,0	54,5	51,0	3,5	
PBEG-80S-3020	80	8	3020	356,52	353,72	314,0	150,0	54,5	51,0	3,5	
PBEG-90S-3020	90	8	3020	401,08	398,29	358,0	180,0	54,5	51,0	3,5	
PBEG-112S-3020	112	10	3020	499,12	496,33	456,0	180,0	54,5	51,0	3,5	GG
PBEG-140S-3020	140	10	3020	623,91	621,11	581,0	200,0	54,5	51,0	3,5	
PBEG-168S-3020	168	10	3020	748,69	745,89	706,0	200,0	54,5	51,0	3,5	

GS400 = spheroidal cast iron - GG = grey cast iron

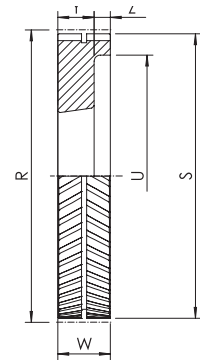

4

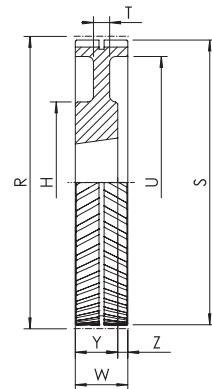

8

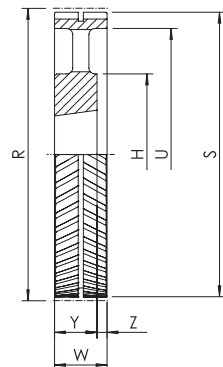

10

Dimensions of timing pulleys EAGLE - mounting taper bushing SER-SIT®

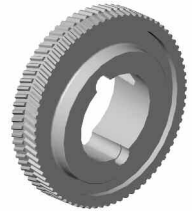

Type "Orange" O - belt width $W = 70$ mm

14M

Code	Teeth nr.	Type	Taper bushing SER-SIT®	R [mm]	S [mm]	U [mm]	H [mm]	W [mm]	Y [mm]	Z [mm]	Material
PBEO-28S-2517	28	4	2517	124,78	121,99	86,0	-	72,0	45,0	27,0	steel
PBEO-30S-2517	30	4	2517	133,69	130,90	90,0	-	72,0	45,0	27,0	
PBEO-32S-2517	32	4	2517	142,61	139,81	100,0	-	72,0	45,0	27,0	
PBEO-34S-3030	34	1	3030	151,52	148,73	-	135,5	72,0	76,0	4,0	
PBEO-36S-3030	36	1	3030	160,43	157,64	-	144,0	72,0	76,0	4,0	
PBEO-38S-3030	38	1	3030	169,35	166,55	-	153,0	72,0	76,0	4,0	
PBEO-40S-3030	40	1	3030	178,26	175,46	-	162,0	72,0	76,0	4,0	
PBEO-43S-3535	43	1	3535	191,63	188,83	-	174,0	72,0	89,0	17,0	
PBEO-45S-3535	45	1	3535	200,54	197,75	-	183,0	72,0	89,0	17,0	
PBEO-48S-3535	48	1	3535	213,91	211,12	-	197,0	72,0	89,0	17,0	
PBEO-50S-3535	50	1	3535	222,82	220,03	-	205,0	72,0	89,0	17,0	
PBEO-56S-3535	56	1	3535	249,56	246,77	-	230,0	72,0	89,0	17,0	
PBEO-60S-3030	60	2	3030	267,39	264,59	225,0	150,0	72,0	76,0	4,0	GS400
PBEO-63S-3030	63	2	3030	280,76	277,96	238,0	150,0	72,0	76,0	4,0	
PBEO-71S-3030	71	2	3030	316,41	313,62	274,0	150,0	72,0	76,0	4,0	
PBEO-75S-3535	75	2	3535	334,24	331,44	291,0	180,0	72,0	89,0	17,0	
PBEO-80S-3535	80	2	3535	356,52	353,72	314,0	180,0	72,0	89,0	17,0	
PBEO-90S-3535	90	2	3535	401,08	398,29	358,0	200,0	72,0	89,0	17,0	GG
PBEO-112S-3535	112	3	3535	499,12	496,33	456,0	200,0	72,0	89,0	17,0	
PBEO-140S-3535	140	3	3535	623,91	621,11	581,0	220,0	72,0	89,0	17,0	
PBEO-168S-3535	168	3	3535	748,69	745,89	706,0	220,0	72,0	89,0	17,0	

GS400 = spheroidal cast iron - GG = grey cast iron

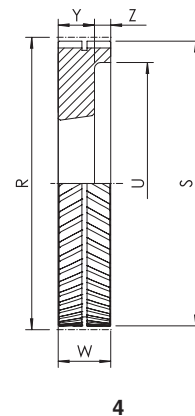
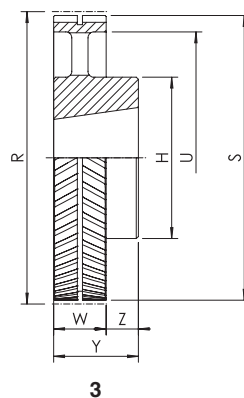
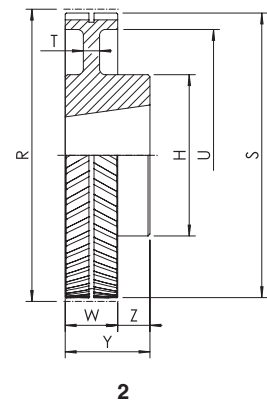
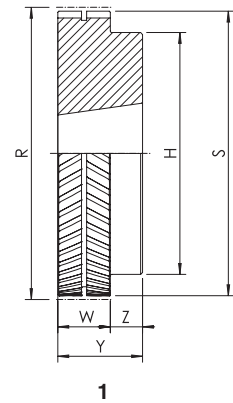

Dimensions of timing pulleys EAGLE - mounting taper bushing SER-SIT®

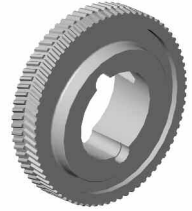

Type "Red" R - belt width $W = 105 \text{ mm}$

14M

Code	Teeth nr.	Type	Taper bushing SER-SIT®	R [mm]	S [mm]	U [mm]	H [mm]	W [mm]	Y [mm]	Z [mm]	Material
PBER -28S-2517	28	9	2517	124,78	121,99	86,0	-	107,0	45,0	31,0	steel
PBER -30S-2517	30	9	2517	133,69	130,90	90,0	-	107,0	45,0	31,0	
PBER -32S-2517	32	9	2517	142,61	139,81	100,0	-	107,0	45,0	31,0	
PBER -34S-3030	34	9	3030	151,52	148,73	109,0	-	107,0	76,0	15,5	
PBER -36S-3030	36	9	3030	160,43	157,64	117,0	-	107,0	76,0	15,5	
PBER -38S-3030	38	9	3030	169,35	166,55	126,0	-	107,0	76,0	15,5	
PBER -40S-3030	40	9	3030	178,26	175,46	135,0	-	107,0	76,0	15,5	
PBER -43S-3535	43	4	3535	191,63	188,83	148,0	-	107,0	89,0	18,0	
PBER -45S-3535	45	4	3535	200,54	197,75	157,0	-	107,0	89,0	18,0	
PBER -48S-4040	48	4	4040	213,91	211,12	171,0	-	107,0	102,0	5,0	
PBER -50S-4040	50	4	4040	222,82	220,03	180,0	-	107,0	102,0	5,0	
PBER -56S-4040	56	4	4040	249,56	246,77	206,0	-	107,0	102,0	5,0	
PBER -60S-3535	60	8	3535	267,39	264,59	225,0	180,0	107,0	89,0	18,0	
PBER -63S-3535	63	8	3535	280,76	277,96	238,0	180,0	107,0	89,0	18,0	
PBER -71S-4040	71	8	4040	316,41	313,62	274,0	200,0	107,0	102,0	5,0	
PBER -75S-4040	75	8	4040	334,24	331,44	291,0	200,0	107,0	102,0	5,0	
PBER -80S-4040	80	8	4040	356,52	353,72	314,0	200,0	107,0	102,0	5,0	
PBER -90S-4040	90	8	4040	401,08	398,29	358,0	220,0	107,0	102,0	5,0	
PBER -112S-4040	112	10	4040	499,12	496,33	456,0	220,0	107,0	102,0	5,0	
PBER -140S-5050	140	3	5050	623,91	621,11	581,0	240,0	107,0	127,0	20,0	
PBER -168S-5050	168	3	5050	748,69	745,89	706,0	240,0	107,0	127,0	20,0	

GS400 = spheroidal cast iron - GG = grey cast iron

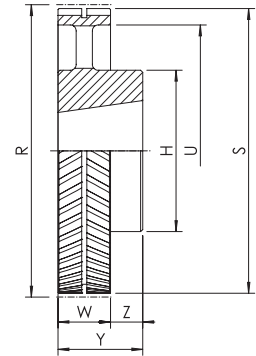

3

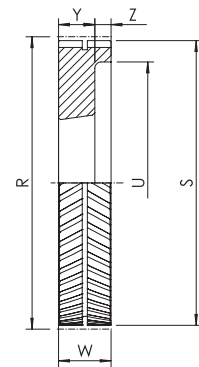

4

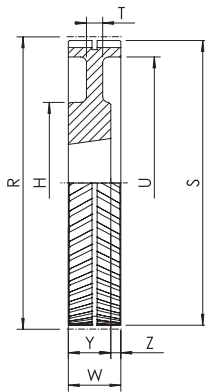

8

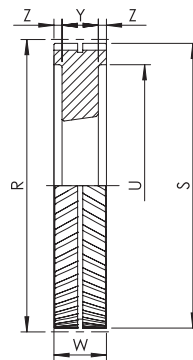

9

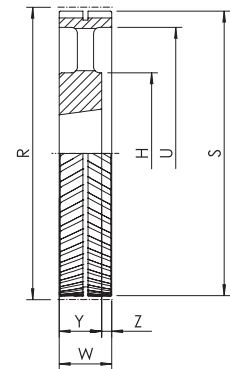

10

Dimensions of timing pulleys EAGLE - solid hub aluminum type



Part Number	PE5M 25 -15S -MPB
EAGLE timing pulley - solid hub	
Belt width in mm	
Number of teeth	
Solid hub	

PE5M - belt width 12,5 mm

5M

Code	Teeth nr.	Type	R [mm]	S [mm]	U [mm]	H [mm]	d [mm]	W [mm]	Y [mm]	Z [mm]	Material
PE5M12,5-15S-MP	15	1	23,87	22,91	-	17,0	6,0	13,5	19,5	6,0	aluminum
PE5M12,5-16S-MP	16	1	25,47	24,51	-	19,0	6,0	13,5	19,5	6,0	
PE5M12,5-18S-MP	18	1	28,65	27,69	-	22,0	6,0	13,5	19,5	6,0	
PE5M12,5-19S-MP	19	1	30,23	29,27	-	24,0	6,0	13,5	21,5	8,0	
PE5M12,5-20S-MP	20	1	31,83	30,87	-	25,0	6,0	13,5	21,5	8,0	
PE5M12,5-22S-MP	22	1	35,01	34,05	-	28,0	6,0	13,5	21,5	8,0	
PE5M12,5-24S-MP	24	1	38,19	37,23	-	32,0	6,0	13,5	21,5	8,0	
PE5M12,5-25S-MP	25	1	39,79	38,83	-	33,0	6,0	13,5	21,5	8,0	
PE5M12,5-26S-MP	26	1	41,38	40,42	-	35,0	6,0	13,5	21,5	8,0	
PE5M12,5-27S-MP	27	1	42,97	42,01	-	36,0	6,0	13,5	21,5	8,0	
PE5M12,5-28S-MP	28	1	44,56	43,60	-	38,0	6,0	13,5	21,5	8,0	
PE5M12,5-30S-MP	30	1	47,75	46,79	-	41,0	12,7	13,5	21,5	8,0	
PE5M12,5-32S-MP	32	1	50,93	49,97	-	44,0	12,7	13,5	21,5	8,0	
PE5M12,5-36S-MP	36	1	57,30	56,34	-	51,0	12,7	13,5	21,5	8,0	
PE5M12,5-40S-MP	40	1	63,66	62,70	-	57,0	12,7	13,5	24,5	11,0	
PE5M12,5-44S-MP	44	1	70,03	69,07	-	63,0	12,7	13,5	24,5	11,0	
PE5M12,5-48S-MP	48	1	76,39	75,43	-	70,0	12,7	13,5	24,5	11,0	
PE5M12,5-60S-MP	60	1	95,49	94,53	-	89,0	12,7	13,5	24,5	11,0	

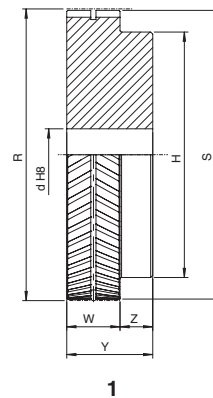

PE5M - belt width 25 mm

5M

Code	Teeth nr.	Type	R [mm]	S [mm]	U [mm]	H [mm]	d [mm]	W [mm]	Y [mm]	Z [mm]	Material
PE5M25-15S-MPB	15	1	23,87	22,91	-	17,0	6,0	26,0	32,0	6,0	aluminum
PE5M25-16S-MPB	16	1	25,47	24,51	-	19,0	6,0	26,0	32,0	6,0	
PE5M25-18S-MPB	18	1	28,65	27,69	-	22,0	6,0	26,0	32,0	6,0	
PE5M25-19S-MPB	19	1	30,23	29,27	-	24,0	6,0	26,0	34,0	8,0	
PE5M25-20S-MPB	20	1	31,83	30,87	-	25,0	6,0	26,0	34,0	8,0	
PE5M25-22S-MPB	22	1	35,01	34,05	-	28,0	6,0	26,0	34,0	8,0	
PE5M25-24S-MPB	24	1	38,19	37,23	-	32,0	6,0	26,0	34,0	8,0	
PE5M25-25S-MPB	25	1	39,79	38,83	-	33,0	6,0	26,0	34,0	8,0	
PE5M25-26S-MPB	26	1	41,38	40,42	-	35,0	6,0	26,0	34,0	8,0	
PE5M25-27S-MPB	27	1	42,97	42,01	-	36,0	6,0	26,0	34,0	8,0	
PE5M25-28S-MPB	28	1	44,56	43,60	-	38,0	6,0	26,0	34,0	8,0	
PE5M25-30S-MPB	30	1	47,75	46,79	-	41,0	12,7	26,0	34,0	8,0	
PE5M25-32S-MPB	32	1	50,93	49,97	-	44,0	12,7	26,0	34,0	8,0	
PE5M25-36S-MPB	36	1	57,30	56,34	-	51,0	12,7	26,0	34,0	8,0	
PE5M25-40S-MPB	40	1	63,66	62,70	-	57,0	12,7	26,0	37,0	11,0	
PE5M25-44S-MPB	44	1	70,03	69,07	-	63,0	12,7	26,0	37,0	11,0	
PE5M25-48S-MPB	48	1	76,39	75,43	-	70,0	12,7	26,0	37,0	11,0	
PE5M25-60S-MPB	60	1	95,49	94,53	-	89,0	12,7	26,0	37,0	11,0	

Dimensions of timing pulleys EAGLE - solid hub aluminum type



Part Number	PE	M	-20S	-MPB
EAGLE timing pulley - solid hub				
Belt width (25 mm)				
Number of teeth				
Solid hub				

PEM - belt width 25 mm

8M

Code	Teeth nr.	Type	R [mm]	S [mm]	H [mm]	d [mm]	W [mm]	Y [mm]	Z [mm]	Max bore	Material
PEM-20S-MPB	20	1	50,93	49,55	41,0	12,7	26,0	38,0	12,0	27,0	aluminum
PEM-22S-MPB	22	1	56,02	54,64	46,0	12,7	26,0	38,0	12,0	31,0	
PEM-24S-MPB	24	1	61,12	59,74	51,0	12,7	26,0	42,0	16,0	34,0	
PEM-26S-MPB	26	1	66,21	64,83	58,0	12,7	26,0	42,0	16,0	39,0	
PEM-28S-MPB	28	1	71,30	69,92	62,0	12,7	26,0	42,0	16,0	41,0	
PEM-30S-MPB	30	1	76,39	75,01	67,0	12,7	26,0	42,0	16,0	45,0	
PEM-32S-MPB	32	1	81,49	80,11	72,0	12,7	26,0	42,0	16,0	48,0	
PEM-34S-MPB	34	1	86,58	85,20	77,0	12,7	26,0	42,0	16,0	51,0	
PEM-36S-MPB	36	1	91,67	90,29	82,0	12,7	26,0	42,0	16,0	55,0	
PEM-38S-MPB	38	1	96,77	95,39	87,0	12,7	26,0	42,0	16,0	58,0	
PEM-40S-MPB	40	1	101,86	100,48	92,0	12,7	26,0	42,0	16,0	62,0	
PEM-56S-MPB	56	1	142,60	141,22	133,0	12,7	26,0	42,0	16,0	89,0	
PEM-90S-MPB	90	2	229,18	227,80	120,0	25,4	26,0	42,0	16,0	80,0	

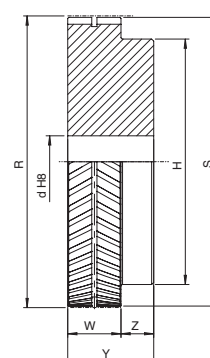

1

PEL - belt width 50 mm

8M

Code	Teeth nr.	Type	R [mm]	S [mm]	H [mm]	d [mm]	W [mm]	Y [mm]	Z [mm]	Max bore	Material
PEL-20S-MPB	20	1	50,93	49,55	41,0	12,7	51,0	63,0	12,0	27,0	aluminum
PEL-22S-MPB	22	1	56,02	54,64	46,0	12,7	51,0	63,0	12,0	31,0	
PEL-24S-MPB	24	1	61,12	59,74	51,0	12,7	51,0	67,0	16,0	34,0	
PEL-26S-MPB	26	1	66,21	64,83	58,0	12,7	51,0	67,0	16,0	39,0	
PEL-28S-MPB	28	1	71,30	69,92	62,0	12,7	51,0	67,0	16,0	41,0	
PEL-30S-MPB	30	1	76,39	75,01	67,0	12,7	51,0	67,0	16,0	45,0	
PEL-32S-MPB	32	1	81,49	80,11	72,0	12,7	51,0	67,0	16,0	48,0	
PEL-34S-MPB	34	1	86,58	85,20	77,0	12,7	51,0	67,0	16,0	51,0	
PEL-36S-MPB	36	1	91,67	90,29	82,0	12,7	51,0	67,0	16,0	55,0	
PEL-38S-MPB	38	1	96,77	95,39	87,0	12,7	51,0	67,0	16,0	58,0	
PEL-40S-MPB	40	1	101,86	100,48	92,0	12,7	51,0	67,0	16,0	62,0	
PEL-56S-MPB	56	1	142,60	141,22	133,0	12,7	51,0	67,0	16,0	89,0	
PEL-90S-MPB	90	2	229,18	227,80	120,0	25,4	51,0	67,0	16,0	80,0	

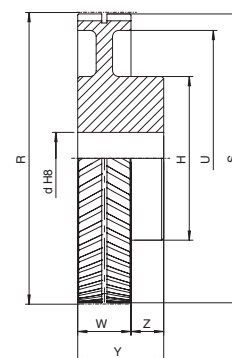

2

Dimensions of timing pulleys EAGLE - solid hub aluminum type



Part Number	PE10M 25 -15S -MPB
EAGLE timing pulley - solid hub	
Belt width (25 mm)	
Number of teeth	
Solid hub	

PE10M - belt width 25 mm

10M

Code	Teeth nr.	Type	R [mm]	S [mm]	U [mm]	H [mm]	d [mm]	W [mm]	Y [mm]	Z [mm]	Max bore [mm]	Material
PE10M25-15S-MPB	15	1	47,75	45,75	-	35,0	12,70	26,0	36,0	10,0	23,0	aluminum
PE10M25-16S-MPB	16	1	50,93	48,93	-	38,0	12,70	26,0	36,0	10,0	25,0	
PE10M25-18S-MPB	18	1	57,30	55,30	-	44,0	12,70	26,0	36,0	10,0	30,0	
PE10M25-19S-MPB	19	1	60,48	58,48	-	47,0	12,70	26,0	36,0	10,0	32,0	
PE10M25-20S-MPB	20	1	63,66	61,66	-	51,0	12,70	26,0	36,0	10,0	34,0	
PE10M25-22S-MPB	22	1	70,03	68,03	-	57,0	12,70	26,0	36,0	10,0	38,0	
PE10M25-24S-MPB	24	1	76,39	74,39	-	63,0	12,70	26,0	36,0	10,0	42,0	
PE10M25-25S-MPB	25	1	79,58	77,58	-	67,0	12,70	26,0	36,0	10,0	44,0	
PE10M25-26S-MPB	26	1	82,76	80,76	-	70,0	12,70	26,0	36,0	10,0	47,0	
PE10M25-27S-MPB	27	1	85,94	83,94	-	73,0	12,70	26,0	36,0	10,0	49,0	
PE10M25-28S-MPB	28	1	89,13	87,13	-	76,0	12,70	26,0	36,0	10,0	51,0	
PE10M25-30S-MPB	30	1	95,49	93,49	-	82,0	12,70	26,0	36,0	10,0	55,0	
PE10M25-32S-MPB	32	1	101,86	99,86	-	89,0	12,70	26,0	36,0	10,0	59,0	
PE10M25-36S-MPB	36	1	114,59	112,59	-	102,0	12,70	26,0	36,0	10,0	68,0	
PE10M25-40S-MPB	40	1	127,32	125,32	-	114,0	12,70	26,0	36,0	10,0	76,0	
PE10M25-44S-MPB	44	1	140,06	138,06	-	127,0	12,70	26,0	36,0	10,0	85,0	
PE10M25-48S-MPB	48	1	152,79	150,79	-	140,0	12,70	26,0	36,0	10,0	93,0	
PE10M25-60S-MPB	60	2	190,99	188,99	162,0	110,0	25,40	26,0	36,0	10,0	65,0	

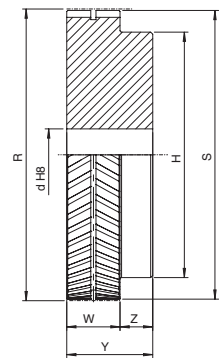

1

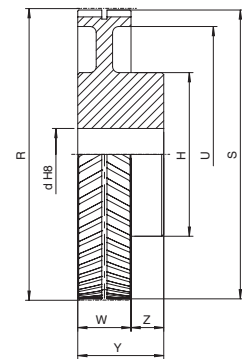

2

PE10M - belt width 32 mm

10M

Code	Teeth nr.	Type	R [mm]	S [mm]	U [mm]	H [mm]	d [mm]	W [mm]	Y [mm]	Z [mm]	Max bore [mm]	Material
PE10M32-15S-MPB	15	1	47,75	45,75	-	35,0	12,70	33,0	43,0	10,0	23,0	aluminum
PE10M32-16S-MPB	16	1	50,93	48,93	-	38,0	12,70	33,0	43,0	10,0	25,0	
PE10M32-18S-MPB	18	1	57,30	55,30	-	44,0	12,70	33,0	43,0	10,0	30,0	
PE10M32-19S-MPB	19	1	60,48	58,48	-	47,0	12,70	33,0	43,0	10,0	32,0	
PE10M32-20S-MPB	20	1	63,66	61,66	-	51,0	12,70	33,0	43,0	10,0	34,0	
PE10M32-22S-MPB	22	1	70,03	68,03	-	57,0	12,70	33,0	43,0	10,0	38,0	
PE10M32-24S-MPB	24	1	76,39	74,39	-	63,0	12,70	33,0	43,0	10,0	42,0	
PE10M32-25S-MPB	25	1	79,58	77,58	-	67,0	12,70	33,0	43,0	10,0	44,0	
PE10M32-26S-MPB	26	1	82,76	80,76	-	70,0	12,70	33,0	43,0	10,0	47,0	
PE10M32-27S-MPB	27	1	85,94	83,94	-	73,0	12,70	33,0	43,0	10,0	49,0	
PE10M32-28S-MPB	28	1	89,13	87,13	-	76,0	12,70	33,0	43,0	10,0	51,0	
PE10M32-30S-MPB	30	1	95,49	93,49	-	82,0	12,70	33,0	43,0	10,0	55,0	
PE10M32-32S-MPB	32	1	101,86	99,86	-	89,0	12,70	33,0	43,0	10,0	59,0	
PE10M32-36S-MPB	36	1	114,59	112,59	-	102,0	12,70	33,0	43,0	10,0	68,0	
PE10M32-40S-MPB	40	1	127,32	125,32	-	114,0	12,70	33,0	43,0	10,0	76,0	
PE10M32-44S-MPB	44	1	140,06	138,06	-	127,0	12,70	33,0	43,0	10,0	85,0	
PE10M32-48S-MPB	48	1	152,79	150,79	-	140,0	12,70	33,0	43,0	10,0	93,0	
PE10M32-60S-MPB	60	2	190,99	188,99	161,0	178,0	25,40	33,0	43,0	10,0	105,0	

Dimensions of timing pulleys EAGLE - solid hub aluminum type



PE10M - belt width 50 mm

10M

Code	Teeth nr.	Type	R [mm]	S [mm]	U [mm]	H [mm]	d [mm]	W [mm]	Y [mm]	Z [mm]	Max bore [mm]	Material
PE10M50-15S-MPB	15	1	47,75	45,75	-	35,0	12,70	51,0	61,0	10,0	23,0	aluminum
PE10M50-16S-MPB	16	1	50,93	48,93	-	38,0	12,70	51,0	61,0	10,0	25,0	
PE10M50-18S-MPB	18	1	57,30	55,30	-	44,0	12,70	51,0	61,0	10,0	30,0	
PE10M50-19S-MPB	19	1	60,48	58,48	-	47,0	12,70	51,0	61,0	10,0	32,0	
PE10M50-20S-MPB	20	1	63,66	61,66	-	51,0	12,70	51,0	61,0	10,0	34,0	
PE10M50-22S-MPB	22	1	70,03	68,03	-	57,0	12,70	51,0	61,0	10,0	38,0	
PE10M50-24S-MPB	24	1	76,39	74,39	-	63,0	12,70	51,0	61,0	10,0	42,0	
PE10M50-25S-MPB	25	1	79,58	77,58	-	67,0	12,70	51,0	61,0	10,0	44,0	
PE10M50-26S-MPB	26	1	82,76	80,76	-	70,0	12,70	51,0	61,0	10,0	47,0	
PE10M50-27S-MPB	27	1	85,94	83,94	-	73,0	12,70	51,0	61,0	10,0	49,0	
PE10M50-28S-MPB	28	1	89,13	87,13	-	76,0	12,70	51,0	61,0	10,0	51,0	
PE10M50-30S-MPB	30	1	95,49	93,49	-	82,0	12,70	51,0	61,0	10,0	55,0	
PE10M50-32S-MPB	32	1	101,86	99,86	-	89,0	12,70	51,0	61,0	10,0	59,0	
PE10M50-36S-MPB	36	1	114,59	112,59	-	102,0	12,70	51,0	61,0	10,0	68,0	
PE10M50-40S-MPB	40	1	127,32	125,32	-	114,0	12,70	51,0	61,0	10,0	76,0	
PE10M50-44S-MPB	44	1	140,06	138,06	-	127,0	12,70	51,0	61,0	10,0	85,0	
PE10M50-48S-MPB	48	1	152,79	150,79	-	140,0	12,70	51,0	61,0	10,0	93,0	
PE10M50-60S-MPB	60	2	190,99	188,99	161,0	178,0	25,40	51,0	61,0	10,0	105,0	

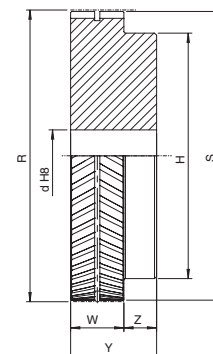

1

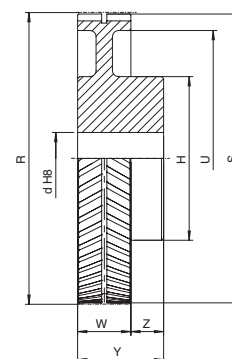

2

Timing Bars

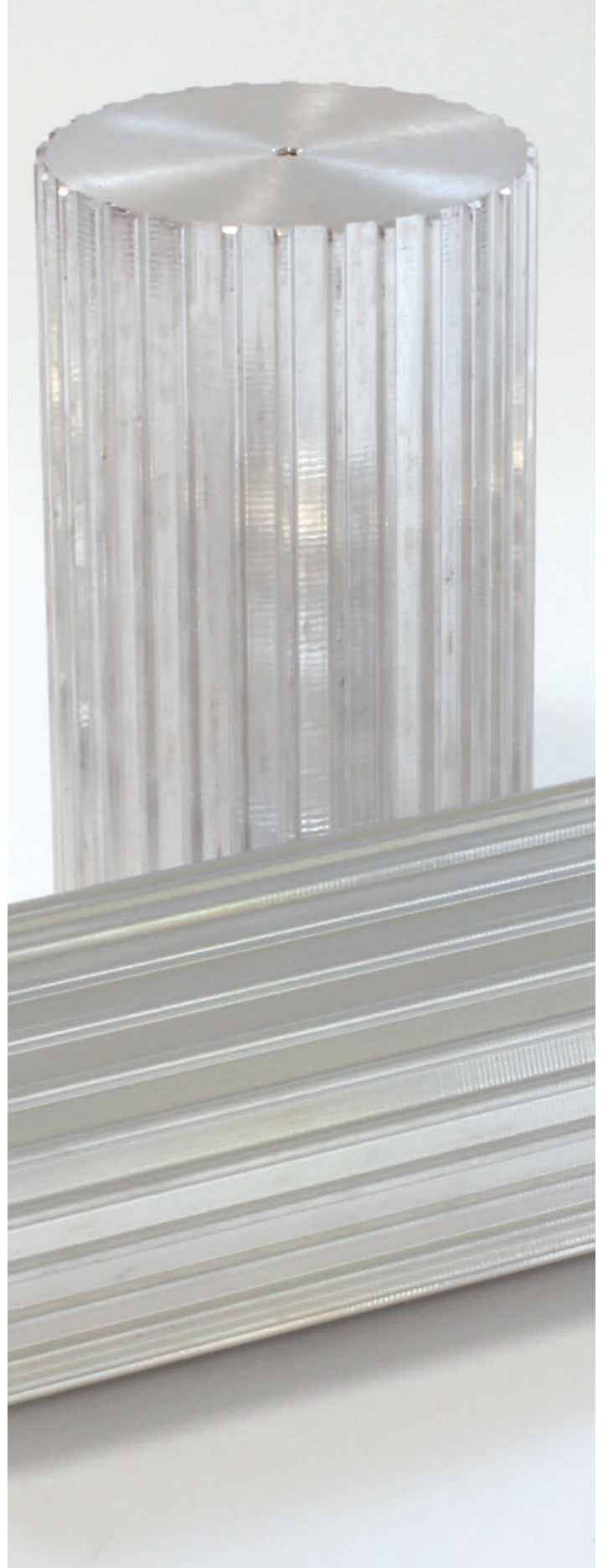

SIT timing bars - IMPERIAL PITCH

Pitches MXL - XL - L

“MXL” timing bars are made of 6082 aluminum suitable for hard anodizing treatment.

“XL” and “L” timing bars are made of C45 steel and of 6082 aluminum suitable for hard anodizing treatment.

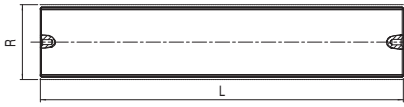

1

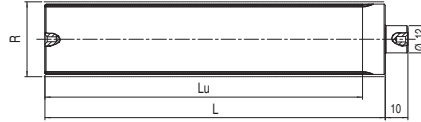

3

Dimensions

MXL 0,080" (2,032 mm)					
ALUMINUM					
Code	Teeth nr.	Type	R [mm]	Lu [mm]	L [mm]
BAR10MXL*	10	3	6,47	50	75
BAR11MXL*	11	3	7,11	50	75
BAR12MXL	12	3	7,76	50	75
BAR13MXL*	13	3	8,41	50	75
BAR14MXL	14	3	9,06	50	75
BAR15MXL	15	3	9,70	50	75
BAR16MXL	16	3	10,35	50	75
BAR17MXL*	17	3	11,00	50	75
BAR18MXL	18	3	11,64	50	75
BAR19MXL*	19	3	12,29	90	120
BAR20MXL	20	3	12,94	90	120
BAR21MXL*	21	3	13,58	90	120
BAR22MXL	22	3	14,23	125	140
BAR23MXL*	23	3	14,88	125	140
BAR24MXL	24	3	15,52	125	140
BAR25MXL	25	3	16,17	125	140
BAR26MXL	26	3	16,82	125	140
BAR27MXL*	27	3	17,46	125	140
BAR28MXL	28	3	18,11	125	140
BAR29MXL*	29	3	18,76	125	140
BAR30MXL	30	3	19,40	125	140
BAR32MXL	32	3	20,70	125	140
BAR34MXL	34	3	21,99	125	140
BAR35MXL*	35	3	22,64	132	140
BAR36MXL	36	3	23,29	132	140
BAR38MXL	38	3	24,58	132	140
BAR40MXL	40	3	25,87	132	140
BAR42MXL	42	3	27,17	140	140
BAR44MXL	44	3	28,46	140	140
BAR45MXL	45	3	29,11	140	140
BAR48MXL	48	3	31,05	140	140
BAR50MXL*	50	3	32,34	140	140
BAR60MXL	60	3	38,81	160	160
BAR64MXL*	64	3	41,40	160	160
BAR65MXL*	65	3	42,04	160	160
BAR70MXL	70	3	45,28	160	160
BAR72MXL	72	3	46,57	160	160
BAR75MXL*	75	3	48,51	160	160
BAR90MXL*	90	3	58,21	160	160
BAR110MXL*	110	3	71,15	160	160

XL 1/5" (5,08 mm)					
STEEL - ALUMINUM					
Code	Teeth nr.	Type	R [mm]	Lu [mm]	L [mm]
BAR10XL	10	1	16,17	140	140
BAR11XL	11	1	17,79	140	140
BAR12XL	12	1	19,4	140	140
BAR13XL	13	1	21,02	140	140
BAR14XL	14	1	22,64	140	140
BAR15XL	15	1	24,25	140	140
BAR16XL	16	1	25,87	140	140
BAR17XL	17	1	27,49	140	140
BAR18XL	18	1	29,11	140	140
BAR19XL	19	1	30,72	140	140
BAR20XL	20	1	32,34	140	140
BAR21XL	21	1	33,96	160	160
BAR22XL	22	1	35,57	160	160
BAR23XL	23	1	37,19	160	160
BAR24XL	24	1	38,81	160	160
BAR25XL	25	1	40,43	160	160
BAR26XL	26	1	42,04	160	160
BAR27XL	27	1	43,66	160	160
BAR28XL	28	1	45,28	160	160
BAR29XL	29	1	46,89	160	160
BAR30XL	30	1	48,51	160	160
BAR32XL	32	1	51,74	160	160
BAR33XL	33	1	53,36	160	160
BAR34XL	34	1	54,98	160	160
BAR35XL	35	1	56,6	160	160
BAR36XL	36	1	58,21	160	160
BAR38XL	38	1	61,45	160	160
BAR39XL	39	1	63,06	160	160
BAR40XL	40	1	64,68	160	160
BAR41XL	41	1	66,3	160	160
BAR42XL	42	1	67,91	160	160
BAR43XL	43	1	69,53	160	160
BAR44XL	44	1	71,15	160	160
BAR48XL	48	1	77,62	160	160
BAR56XL	56	1	90,55	160	160
BAR60XL	60	1	97,02	160	160
BAR72XL	72	1	116,43	160	160

L 3/8" (9,525 mm)					
STEEL - ALUMINUM					
Code	Teeth nr.	Type	R [mm]	Lu [mm]	L [mm]
BAR10L	10	1	30,32	140	140
BAR11L	11	1	33,35	140	140
BAR12L	12	1	36,38	160	160
BAR13L	13	1	39,41	160	160
BAR14L	14	1	42,45	160	160
BAR15L	15	1	45,48	160	160
BAR16L	16	1	48,51	160	160
BAR17L	17	1	51,54	160	160
BAR18L	18	1	54,57	160	160
BAR19L	19	1	57,61	160	160
BAR20L	20	1	60,64	160	160
BAR21L	21	1	63,67	160	160
BAR22L	22	1	66,7	160	160
BAR23L	23	1	69,73	160	160
BAR24L	24	1	72,77	160	160
BAR27L	27	1	81,86	160	160
BAR30L	30	1	90,96	160	160

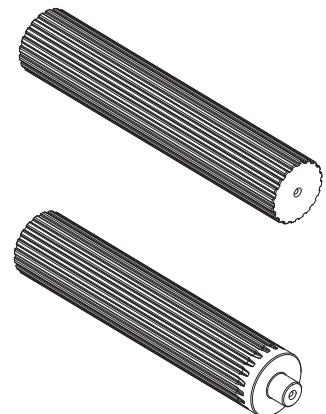

1

3

*= available on demand

Part Number **BAR 40 XL / AC**

Timing Bar _____

Teeth number _____

Pitch _____

Material - AC: steel; AL: aluminum _____

Pitches 3M - 5M - 8M

“TOP DRIVE® HTD” timing bars are made of 6082 aluminum suitable for hard anodizing treatment.

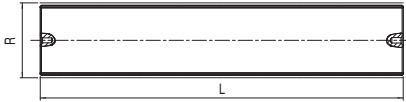

1

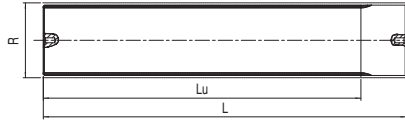

2

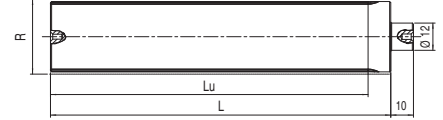

3

Dimensions

HTD 3M pitch 3 mm					
ALUMINUM					
Code	Teeth nr.	Type	R [mm]	Lu [mm]	L [mm]
BAR9-3M*	9	3	8,59	75	100
BAR10-3M	10	3	9,55	75	100
BAR11-3M*	11	3	10,50	75	100
BAR12-3M	12	3	11,46	100	125
BAR13-3M*	13	3	12,41	100	125
BAR14-3M	14	3	13,37	100	125
BAR15-3M	15	3	14,32	100	125
BAR16-3M	16	3	15,28	125	155
BAR17-3M*	17	3	16,23	125	155
BAR18-3M	18	3	17,19	125	155
BAR19-3M*	19	3	18,14	125	155
BAR20-3M	20	3	19,10	150	165
BAR21-3M	21	3	20,05	150	165
BAR22-3M	22	3	21,01	150	165
BAR23-3M*	23	3	21,96	150	165
BAR24-3M	24	3	22,92	150	165
BAR25-3M*	25	3	23,87	150	165
BAR26-3M	26	3	24,83	150	165
BAR27-3M*	27	3	25,78	150	165
BAR28-3M	28	3	26,74	150	165
BAR29-3M*	29	3	27,69	150	165
BAR30-3M	30	3	28,65	175	183
BAR31-3M*	31	3	29,60	175	183
BAR32-3M	32	3	30,56	175	183
BAR33-3M*	33	3	31,51	175	183
BAR34-3M	34	3	32,47	175	183
BAR35-3M*	35	3	33,42	175	183
BAR36-3M	36	3	34,38	200	200
BAR37-3M*	37	3	35,33	200	200
BAR38-3M	38	3	36,29	200	200
BAR39-3M*	39	3	37,24	200	200
BAR40-3M	40	3	38,20	200	200
BAR42-3M*	42	3	40,11	200	200
BAR44-3M	44	3	42,02	200	200
BAR45-3M*	45	3	42,97	200	200
BAR48-3M	48	3	45,84	200	200
BAR50-3M*	50	3	47,75	200	200
BAR52-3M*	52	3	49,66	200	200
BAR54-3M*	54	3	51,57	200	200
BAR56-3M*	56	3	53,48	200	200
BAR60-3M	60	3	57,30	200	200
BAR62-3M*	62	3	59,21	200	200
BAR64-3M*	64	3	61,12	200	200
BAR66-3M*	66	3	63,03	200	200
BAR68-3M*	68	3	64,94	200	200
BAR70-3M*	70	3	66,85	200	200
BAR72-3M*	72	3	68,75	200	200

HTD 5M pitch 5 mm					
ALUMINUM					
Code	Teeth nr.	Type	R [mm]	Lu [mm]	L [mm]
BAR12-5M	12	2	19,10	150	165
BAR13-5M	13	2	20,69	150	165
BAR14-5M	14	2	22,28	175	183
BAR15-5M	15	2	23,87	175	183
BAR16-5M	16	2	25,46	175	183
BAR17-5M	17	2	27,06	175	183
BAR18-5M	18	1	28,65	200	200
BAR19-5M	19	1	30,24	200	200
BAR20-5M	20	1	31,83	200	200
BAR21-5M	21	1	33,42	200	200
BAR22-5M	22	1	35,01	200	200
BAR23-5M	23	1	36,61	200	200
BAR24-5M	24	1	38,20	200	200
BAR25-5M	25	1	39,79	200	200
BAR26-5M	26	1	41,38	200	200
BAR27-5M	27	1	42,97	200	200
BAR28-5M	28	1	44,56	200	200
BAR29-5M	29	1	46,15	200	200
BAR30-5M	30	1	47,75	200	200
BAR31-5M	31	1	49,34	200	200
BAR32-5M	32	1	50,93	200	200
BAR33-5M	33	1	52,52	200	200
BAR34-5M	34	1	54,11	200	200
BAR35-5M	35	1	55,70	200	200
BAR36-5M	36	1	57,30	200	200
BAR38-5M	38	1	60,48	200	200
BAR40-5M	40	1	63,66	200	200
BAR42-5M	42	1	66,85	200	200
BAR44-5M	44	1	70,03	200	200
BAR45-5M	45	1	71,62	200	200
BAR46-5M	46	1	73,21	200	200
BAR48-5M	48	1	76,39	200	200
BAR50-5M	50	1	79,58	200	200
BAR54-5M	54	1	85,94	200	200
BAR60-5M	60	1	95,49	200	200
BAR62-5M	62	1	98,68	200	200
BAR72-5M	72	1	114,59	200	200

HTD 8M pitch 8 mm					
ALUMINUM					
Code	Teeth nr.	Type	R [mm]	Lu [mm]	L [mm]
BAR18-8M	18	1	45,84	200	200
BAR19-8M	19	1	48,38	200	200
BAR20-8M	20	1	50,93	200	200
BAR21-8M	21	1	53,48	200	200
BAR22-8M	22	1	56,02	200	200
BAR23-8M	23	1	58,57	200	200
BAR24-8M	24	1	61,12	200	200
BAR25-8M	25	1	63,66	200	200
BAR26-8M	26	1	66,21	200	200
BAR28-8M	28	1	71,30	200	200
BAR30-8M	30	1	76,39	200	200
BAR32-8M	32	1	81,49	200	200
BAR34-8M	34	1	86,58	200	200
BAR35-8M	35	1	89,13	200	200
BAR36-8M	36	1	91,67	200	200
BAR38-8M	38	1	96,77	200	200
BAR40-8M	40	1	101,86	200	200
BAR44-8M	44	1	112,05	200	200
BAR48-8M	48	1	122,23	200	200

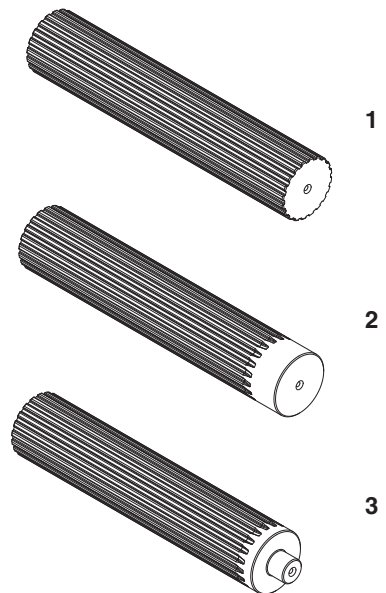

Part Number **BAR 25 - 5M / AL**

Timing Bar _____

Teeth number _____

Pitch _____

Material - AL: aluminum

*= available on demand

SIT timing bars - METRIC PITCH

Pitches T 2,5 - T 5 - T 10

“T” timing bars are made of 6082 aluminum suitable for hard anodizing treatment.

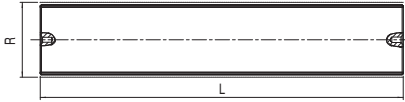

1

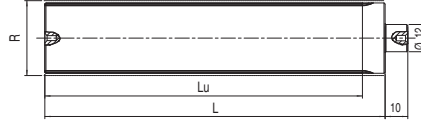

3

Dimensions

T 2,5 pitch 2,5 mm					
ALUMINUM					
Code	Teeth nr.	Type	R [mm]	Lu [mm]	L [mm]
BAR10T2,5	10	3	7,96	50	75
BAR12T2,5	12	3	9,55	50	75
BAR13T2,5	13	3	10,35	50	75
BAR14T2,5	14	3	11,14	50	75
BAR15T2,5	15	3	11,94	50	75
BAR16T2,5	16	3	12,73	50	75
BAR17T2,5	17	3	13,53	50	75
BAR18T2,5	18	3	14,32	50	75
BAR19T2,5	19	3	15,12	90	120
BAR20T2,5	20	3	15,92	90	120
BAR21T2,5	21	3	16,71	90	120
BAR22T2,5	22	3	17,51	125	140
BAR24T2,5	24	3	19,10	125	140
BAR26T2,5	26	3	20,69	125	140
BAR27T2,5	27	3	21,49	125	140
BAR28T2,5	28	3	22,28	125	140
BAR29T2,5	29	3	23,08	125	140
BAR30T2,5	30	3	23,87	125	140
BAR32T2,5	32	3	25,46	125	140
BAR34T2,5	34	3	27,06	125	140
BAR35T2,5	35	3	27,85	132	140
BAR36T2,5	36	3	28,65	132	140
BAR38T2,5	38	3	30,24	132	140
BAR40T2,5	40	3	31,83	132	140
BAR42T2,5	42	3	33,42	140	140
BAR44T2,5	44	3	35,01	140	140
BAR45T2,5	45	3	35,81	140	140
BAR48T2,5	48	3	38,20	140	140
BAR50T2,5	50	3	39,79	160	160
BAR60T2,5	60	3	47,75	160	160
BAR65T2,5	65	3	51,73	160	160
BAR70T2,5	70	3	55,70	160	160
BAR72T2,5	72	3	57,30	160	160
BAR90T2,5	90	3	71,62	160	160
BAR100T2,5	100	3	79,58	160	160

T 5 pitch 5 mm					
ALUMINUM					
Code	Teeth nr.	Type	R [mm]	Lu [mm]	L [mm]
BAR10T5	10	1	15,91	140	140
BAR11T5	11	1	17,5	140	140
BAR12T5	12	1	19,1	140	140
BAR13T5	13	1	20,69	140	140
BAR14T5	14	1	22,28	140	140
BAR15T5	15	1	23,87	140	140
BAR16T5	16	1	25,47	140	140
BAR17T5	17	1	27,06	140	140
BAR18T5	18	1	28,65	140	140
BAR19T5	19	1	30,24	140	140
BAR20T5	20	1	31,83	160	160
BAR21T5	21	1	33,42	160	160
BAR22T5	22	1	35,01	160	160
BAR23T5	23	1	36,61	160	160
BAR24T5	24	1	38,19	160	160
BAR25T5	25	1	39,79	160	160
BAR26T5	26	1	41,38	160	160
BAR27T5	27	1	42,97	160	160
BAR28T5	28	1	44,56	160	160
BAR29T5	29	1	46,16	160	160
BAR30T5	30	1	47,15	160	160
BAR32T5	32	1	50,93	160	160
BAR34T5	34	1	54,11	160	160
BAR35T5	35	1	55,71	160	160
BAR36T5	36	1	57,3	160	160
BAR37T5	37	1	58,89	160	160
BAR38T5	38	1	60,48	160	160
BAR40T5	40	1	63,66	160	160
BAR42T5	42	1	68,85	160	160
BAR44T5	44	1	70,03	160	160
BAR45T5	45	1	71,62	160	160
BAR46T5	46	1	73,21	160	160
BAR48T5	48	1	76,39	160	160
BAR50T5	50	1	79,58	160	160
BAR60T5	60	1	95,49	160	160
BAR72T5	72	1	114,59	160	160
BAR80T5	80	1	127,32	160	160
BAR90T5	90	1	143,24	160	160
BAR100T5	100	1	159,15	160	160

T 10 pitch 10 mm					
ALUMINUM					
Code	Teeth nr.	Type	R [mm]	Lu [mm]	L [mm]
BAR10T10	10	1	31,83	140	140
BAR11T10	11	1	35,01	140	140
BAR12T10	12	1	38,19	140	140
BAR13T10	13	1	41,38	140	140
BAR14T10	14	1	44,56	160	160
BAR15T10	15	1	47,74	160	160
BAR16T10	16	1	50,93	160	160
BAR17T10	17	1	54,11	160	160
BAR18T10	18	1	57,29	160	160
BAR19T10	19	1	60,47	160	160
BAR20T10	20	1	63,66	160	160
BAR21T10	21	1	66,84	160	160
BAR22T10	22	1	70,02	160	160
BAR23T10	23	1	73,21	160	160
BAR24T10	24	1	76,39	160	160
BAR26T10	26	1	82,76	160	160
BAR28T10	28	1	89,12	160	160
BAR30T10	30	1	95,49	160	160
BAR32T10	32	1	101,85	160	160
BAR34T10	34	1	108,22	160	160
BAR36T10	36	1	114,59	160	160
BAR38T10	38	1	120,95	160	160
BAR40T10	40	1	127,32	160	160
BAR45T10	45	1	143,23	160	160
BAR48T10	48	1	152,78	160	160
BAR60T10	60	1	190,98	160	160
BAR72T10	72	1	229,17	160	160

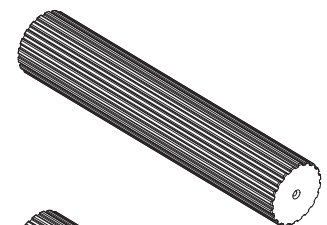

1

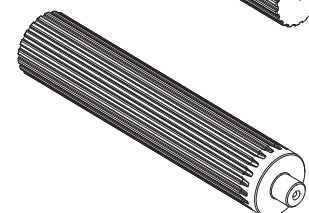

3

Part Number **BAR 22 T10 / AL**

Timing Bar _____

Teeth number _____

Pitch _____

Material - AL: aluminum _____

Pitches AT 5 - AT 10

“AT” timing bars are made of 6082 aluminum suitable for hard anodizing treatment.

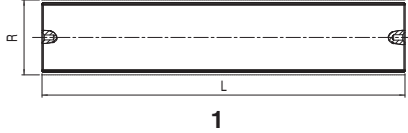

Part Number **BAR 28 AT10 / AL**

Timing Bar

Teeth number

Pitch

Material - AL: aluminum

Dimensions

AT 5 pitch 5 mm					
ALUMINUM					
Code	Teeth nr.	Type	R [mm]	Lu [mm]	L [mm]
BAR12AT5	12	1	19,1	140	140
BAR13AT5	13	1	20,69	140	140
BAR14AT5	14	1	22,28	140	140
BAR15AT5	15	1	23,87	140	140
BAR16AT5	16	1	25,47	140	140
BAR17AT5	17	1	27,06	140	140
BAR18AT5	18	1	28,65	140	140
BAR19AT5	19	1	30,24	140	140
BAR20AT5	20	1	31,83	160	160
BAR21AT5	21	1	33,42	160	160
BAR22AT5	22	1	35,01	160	160
BAR23AT5	23	1	36,61	160	160
BAR24AT5	24	1	38,19	160	160
BAR25AT5	25	1	39,79	160	160
BAR26AT5	26	1	41,38	160	160
BAR27AT5	27	1	42,97	160	160
BAR28AT5	28	1	44,56	160	160
BAR29AT5	29	1	46,16	160	160
BAR30AT5	30	1	47,15	160	160
BAR31AT5	31	1	49,34	160	160
BAR32AT5	32	1	50,93	160	160
BAR33AT5	33	1	52,52	160	160
BAR34AT5	34	1	54,11	160	160
BAR35AT5	35	1	55,71	160	160
BAR36AT5	36	1	57,3	160	160
BAR38AT5	38	1	60,48	160	160
BAR40AT5	40	1	63,66	160	160
BAR42AT5	42	1	68,85	160	160
BAR44AT5	44	1	70,03	160	160
BAR45AT5	45	1	71,62	160	160
BAR46AT5	46	1	73,21	160	160
BAR48AT5	48	1	76,39	160	160
BAR50AT5	50	1	79,58	160	160
BAR52AT5	52	1	82,76	160	160
BAR54AT5	54	1	85,94	160	160
BAR55AT5	55	1	87,54	160	160
BAR56AT5	56	1	89,13	160	160
BAR58AT5	58	1	92,31	160	160
BAR60AT5	60	1	95,49	160	160
BAR62AT5	62	1	98,68	160	160
BAR64AT5	64	1	101,86	160	160
BAR65AT5	65	1	103,45	160	160
BAR70AT5	70	1	111,41	160	160
BAR72AT5	72	1	114,59	160	160

AT 10 pitch 10 mm					
ALUMINUM					
Code	Teeth nr.	Type	R [mm]	Lu [mm]	L [mm]
BAR14AT10	14	1	44,56	160	160
BAR15AT10	15	1	47,75	160	160
BAR16AT10	16	1	50,93	160	160
BAR17AT10	17	1	54,11	160	160
BAR18AT10	18	1	57,30	160	160
BAR19AT10	19	1	60,48	160	160
BAR20AT10	20	1	63,66	160	160
BAR21AT10	21	1	66,85	160	160
BAR22AT10	22	1	70,03	160	160
BAR23AT10	23	1	73,21	160	160
BAR24AT10	24	1	76,39	160	160
BAR25AT10	25	1	79,58	160	160
BAR26AT10	26	1	82,76	160	160
BAR27AT10	27	1	85,94	160	160
BAR28AT10	28	1	89,13	160	160
BAR29AT10	29	1	92,31	160	160
BAR30AT10	30	1	95,49	160	160
BAR31AT10	31	1	98,68	160	160
BAR32AT10	32	1	101,86	160	160
BAR33AT10	33	1	105,04	160	160
BAR34AT10	34	1	108,23	160	160
BAR35AT10	35	1	111,41	160	160
BAR36AT10	36	1	114,59	160	160
BAR37AT10	37	1	117,77	160	160
BAR38AT10	38	1	120,96	160	160
BAR40AT10	40	1	127,32	160	160
BAR41AT10	41	1	130,51	160	160
BAR42AT10	42	1	133,69	160	160
BAR44AT10	44	1	140,06	160	160
BAR45AT10	45	1	143,24	160	160
BAR46AT10	46	1	146,42	160	160
BAR48AT10	48	1	152,79	160	160
BAR50AT10	50	1	159,15	160	160
BAR51AT10	51	1	162,34	160	160
BAR52AT10	52	1	165,52	160	160
BAR54AT10	54	1	171,89	160	160
BAR55AT10	55	1	175,07	160	160
BAR56AT10	56	1	178,25	160	160
BAR57AT10	57	1	181,44	160	160
BAR58AT10	58	1	184,62	160	160
BAR59AT10	59	1	187,80	160	160
BAR60AT10	60	1	190,99	160	160
BAR62AT10	62	1	197,35	160	160
BAR70AT10	70	1	222,82	160	160

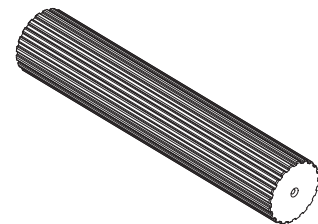

1

Flanges



SIT Flanges

Material: P11 UNI EN 10111 (Upon request, stainless steel and aluminum flanges can be supplied.)
 Finishing: Galvanized
 Production process: Molding

Special flanges according to SIT standards.

Pulleys shown in this catalog do not necessarily use these special flanges.

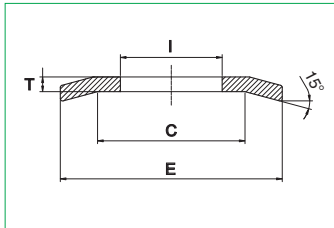

Part Number	FL - 7 SP1,5 ZN
Flange for timing pulley	
Size	
Thickness	
Galvanized	

Dimensions of special flanges according to SIT standard.

Flange type	Internal diameter I [mm]	Diameter C [mm]	External diameter E [mm]	Flange thickness T [mm]	Number of pulley teeth								Flange thickness T [mm]	3 mm ST - RP - HD	Flange thickness T [mm]	Number of pulley teeth					
					XL	L	H	XH	XXH	T20	8 mm ST - RP - HD - PBG	14mm ST - RP - HD - PBG				4.5 mm ST - RP - HD	5 mm ST - RP - HD	T2,5	T5 - AT5	T10 - AT10	
0/0	6,5	-	12	0,6										0,5	10	1			12-13		
0/1	8,5	-	16	1										0,5	12-13	1			14-15		
0/2	10	-	18	1										0,5	14	1			16-18	10	
0/3	12,5	-	21,5	1										0,5		1	12		19		
0/4	9	-	16	1										0,5	15	1					
0/5	13	-	19	0,5										0,5		1					
1	13	17	20	1	10-11									0,5	16-19	1	13		20-22	11	
1/1	15	19	23	1										0,5	20	1		12	24	12	
2	16	21	24	1	12-13									0,5	21	1	14-15	14	25-26	14	
2/1	17	22	25	1										0,5	22-23	1					
3	19	24	27	1	14-15									0,5	24 spec.	1	16-17	15-16	28-30	15	
3/1	21	26,5	29,5	1										0,5		1					
3/2	19	22	25	0,5										0,5	24-26	-					
4	22	27	30	1	16-17									0,5	27-29	1	18-19	17-18	32-34	16-18	
4/1	22	30	33	1										0,5		1					
5	25	30	33	1,5	18	10								0,5	30-32	1	20-21	20	35-37	19-20	
5/1	28		34	0,5										0,5		-					
6	28	32	36	1,5	19-20	11								0,5	33-35	1	22-23	21-22	38-40	21-22	
6/1	31		36	1,5										0,5		1					
7	31	36	40	1,5	21-22-23	12								0,5	36-39	1	25-26	24	42-44	24	12
7/1	31	40	47	1,5		13					16-17			0,5		1	27-28				13
7/2	31	40	42	-										-		1				24	
8	35	42	46	1,5	24-25-26	14								0,5	40-44	1	29	26	25-27	14	
8/1	36	45	50	1,5								18		0,5		1	30-31				
8/2	35	42	44	1										0,5		1					
8/3	37	48	43	1,5										-		-					
9	39	46	50	1,5	27-28-29	15	12					19		0,5		1	32-33	28-30		28-30	15
9/1	41	50	55	1,5								20		0,5		1	34				
9/2	39	46	51	1,5								20		0,5		1				30	
9/3	41	46	51	-								20		0,5		1				30	
10	43	48	55	1,5	30	16-17						21		0,5		1	35-36	32		31-33	16
10/1	47	52	57	1,5	32									0,5		1		34			
10/2	43	48	54	1										0,5		1					
10/3	46	51	57	1,5										-		-					
11	47	55	62	1,5	35-36	18-19	14					22-23		0,5		1	37-38	36		34-36	17-18
11/1	51	61	67	1,5								24		0,5	64	1	39-40	38			
11/2	47	55	60	1,5								22		0,5		-					
12	53	60	67	1,5		20-21	16					25		0,5		1	41	40		37-40	19-20
13	56	65	73	1,5	40-42	22-23						26-27		0,5		1		44		41-42	21-22
13/1	60	70	77	1,5	44		17					28		0,5		1					23
13/2	60	73	79	1,5										-		-					
13/3	56	65	70	1,5								26		-		-					
13/4	57	68	75	1,5								28		-		-					

Flange type	Internal diameter I [mm]	Diameter C [mm]	External diameter E [mm]	Flange thickness T [mm]	Number of pulley teeth							Flange thickness T [mm]	3 mm ST - RP - HD	Flange thickness T [mm]	Number of pulley teeth				
					XL	L	H	XH	XXH	T20	8 mm ST - RP - HD - PBG				14mm ST - RP - HD - PBG	4,5 mm ST - RP - HD	5 mm ST - RP - HD	T2,5	T5 - AT5
14	64	72	80	1,5		24-25	18				29		-	1					24
14/1	71	77,3	80	-									-	1				48	
14/2	71	77,3	79,5	-									-	1				48	
15	68	79	84	1,5	48		19				30-31		-	1		48			25
16	71	80	88	1,5		26-27	20				32-33		-	1					26-27
16/1	75	84	90	1,5									-	1					
16/2	75	88	94	1,5							34		-	-					
17	78	88	94	1,5	52	28-29	21-22				35		-	1		56			28-29
18	80	90	98	1,5	57	30	23				36		-	1					30
19	83	94	100	1,5		31-32					37		-	1			60		31
20	88	96	104	1,5			24-25				38-39		-	1		60			
20/1	90	101	108	1,5	60	33					40		-	1		64			
20/2	92,6	100,5	106	3							40		-	1					
21	93	102	108	1,5		34	26				41		-	1					32-33
21/1	94	106	111	1,5							42		-	1				66	
22	96	105	113	1,5		35-36	27				43		-	1				68	34-35
23	102	112	118	1,5		37	28						-	1					36
24	104	113	121	1,5	72	38-39	29				44-45		-	1					37
24/1	105	120	127	1,5							46-47		-	1					38
25	108	125	134	2,5				18		20		28-29	-	1					
26	112	121	129	1,5		40-41	30				48-49		-	1					39-40
26/1	115	126	131	1,5			31				50		-	1					
27	115	132	142	2,5				19				30	-	1					
28	120	128	137	1,5		42-43	32-33				51-52		-	1					
29	122	138	150	2,5				20		22		31-32	-	1					
30	126	136	142	1,5		44-45	34				53-54		-	1			86		
31	130	140	145	1,5		46	35				55		-	-					
32	130	146	158	2,5				21		24		33-34	-	-					
33	134	141	149	1,5		47					56-57		-	-					
34	135	145	151	1,5		48	36				58		-	-					
34/1	142	154	158	1,5		49	37				60-61		-	-					
35	136	153	166	2,5				22-23		25		35-36	-	-					
36	143	152	158	1,5		50-51	38						-	-					
36/1	146	158	166	1,5		52	39				62		-	-					
37	149	167	177	2,5				24				37-38	-	-					
38	151	160	168	1,5		53-54	40				64-65		-	-					
39	156	176	186	2,5				25	18			39-40	-	-					
40	158	167	175	1,5		55-56	41-42				66-67		-	-					
40/1	161	176	182	1,5							68-70		-	-					
41	165	181	191	2,5				26				41-42	-	-					
42	166	176	182	1,5		57-58	43						-	-					
42/1	170	184	191	1,5			44				71-72		-	-					
43	166	188	200	2,5				27	19	30		43	-	-					
44	172	177	189	1,5		59-60	45-46						-	-					
45	177	197	209	2,5					20	32		44-45	-	-					
46	182	193	199	1,5			47-48	28					-	-					
47	180	195	202	1,5			49-50						-	-					
48	194	210	216	2,5			51-52-53	30	21			48	-	-					
49	208	224	232	2,5			54-55-56	32	22			50	-	-					
49/1	210	-	240	2,5								51-52	-	-					
50	222	238	266	2,5			57-58-59	34	24			54-55	-	-					
51	232	252	261	2,5			60-61	36	25			56-57	-	-					
51/1	238	261	272	2,5			62-63		26			58-59	-	-					
52	250	266	274	2,5			64-65-66	38				60	-	-					
52/1	260	277	288	2,5			67-68	40	28			62	-	-					
53	264	280	288	2,5		90	69-70					63-64	-	-					
54	284	-	325	1,5									-	-					
55	285	-	333	3								72	-	-					
56	322	-	369	3								80	-	-					

Clamp plates

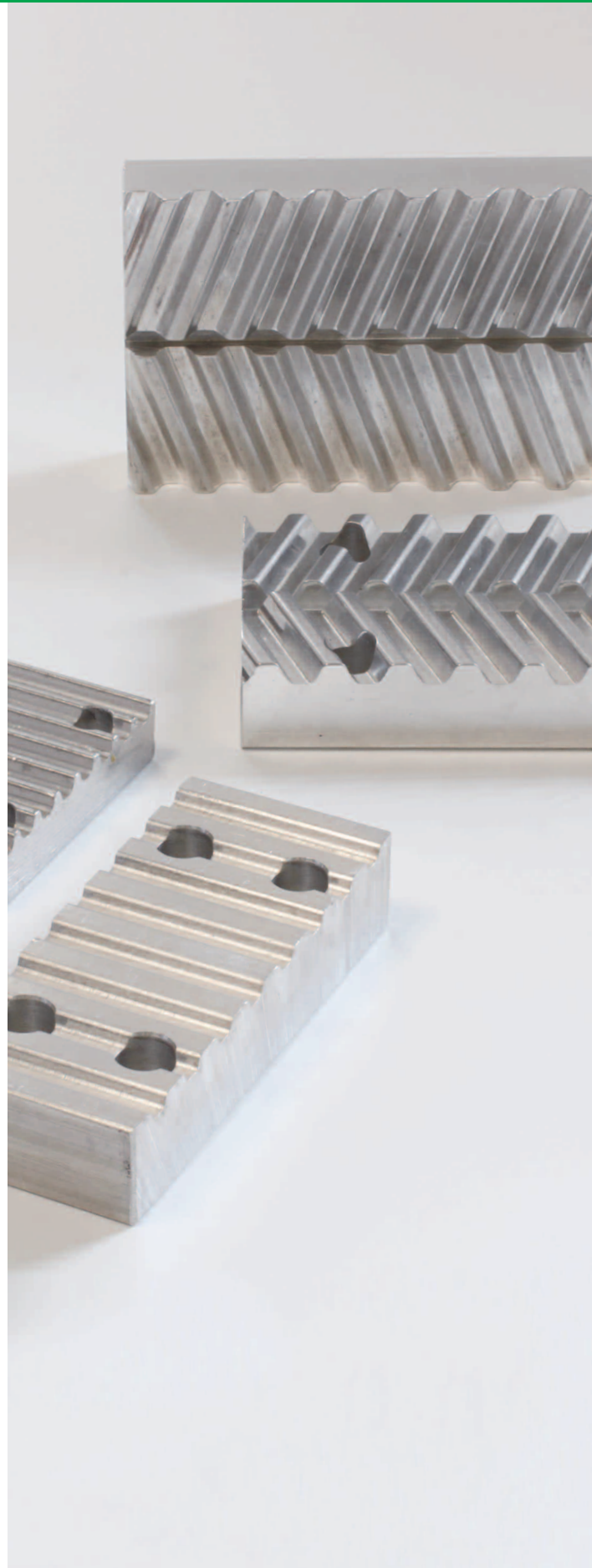

SIT Clamp plates

Clamp plates may be used as positive attachment of the belt ends in numerous applications in linear drives.

Clamp plates must have the correct belt profile, guarantee a uniform clamping force on all the clamped belt surface and must be rigid. For standard applications a minimum of 7 teeth in clamp is recommended.

For use with timing belts with special cords (e.g. HPL), a minimum of 12 teeth in clamp is recommended, so a special execution is required.

Clamp plates can be supplied both in finished version and in raw version too.

Standard material: aluminum.

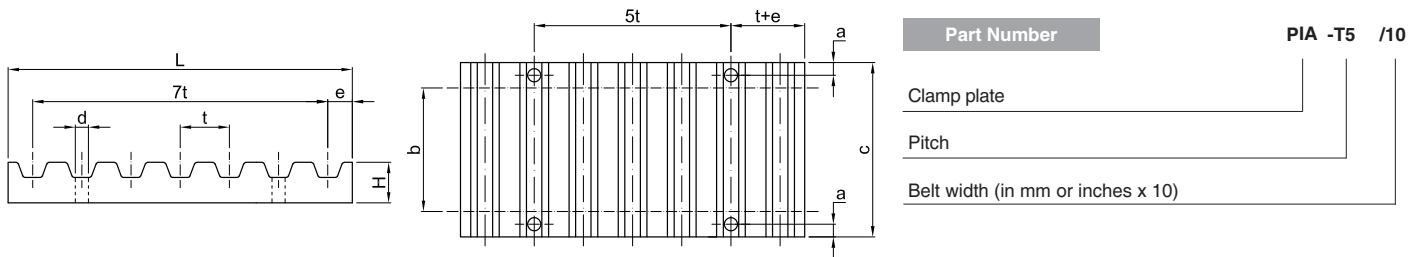

Type	a [mm]	d [mm]	e [mm]	L [mm]	H [mm]	Belt width [mm]									
						6	10	16	25	32	50	75	100	150	
						C									
T5	6	5,5	3,2	41,8	8	-	29	35	44	-	-	-	-	-	
AT5	6	5,5	3,2	41,8	8	-	29	35	44	-	-	-	-	-	
T10	8	9	5	80	15	-	-	41	50	57	75	100	125	175**	
AT10	8	9	5	80	15	-	-	41	50	57	75	100	125	175**	
T20*	10	11	10	160	20	-	-	-	56	63	81	106	132	182	
AT20*	10	11	10	160	20	-	-	-	56	63	81	106	132	182	

Type	a [mm]	d [mm]	e [mm]	L [mm]	H [mm]	Belt width [inch/100]							
						025	032	037	050	075	100	150	200
						C [mm]							
XL	6	5,5	3,5	42,5	8	25,5	27	28,5	-	-	-	-	-
L	8	9	6	76,6	15	-	-	36	39	45	51,5	64	77
H	10	11	9	106,9	22	-	-	-	45	51	57,5	70	83

Type	a [mm]	d [mm]	e [mm]	L [mm]	H [mm]	Belt width [mm]											
						6	9	15	20	25	30	40	50	55	85	115	170
						C [mm]											
3M	5	4,5	2	25	5	21	24	21	24	30	-	-	-	-	-	-	-
5M	6	5,5	3,4	41,8	8	-	28	34	-	44	-	-	-	-	-	-	-
8M	8	9	5	66	15	-	-	40	45	-	55	-	75	-	110	-	-
14M	10	11	9	116	22	-	-	-	-	56	-	71	-	86	116	146	201**

* = Pitch on request
** = width on request

EAGLE Belts	Clamp plates					Belt width [mm]												
	Pitch	b	d	f	Length [mm]	H	12,5	25	16	25	32	50	75	100	35	52,5	70	105
							Clamp plate width [mm]											
EAGLE 5	6	5,5	8,5	47	7,5	30	-	-	-	-	-	-	-	-	-	-	-	-
	7					45	-	-	-	-	-	-	-	-	-	-	-	-
EAGLE 8	7,5	9	13	74	14,5	-	-	40	-	-	-	-	-	-	-	-	-	-
	8					-	-	50	57	75	-	-	-	-	-	-	-	-
EAGLE 10	8	9	17	94	14,5	-	-	-	50	57	75	100	125	-	-	-	-	-
EAGLE 14	9,5	11	23	130	22	-	-	-	-	-	-	-	-	65	82,5	100	-	-
	10					-	-	-	-	-	-	-	-	-	-	-	-	-

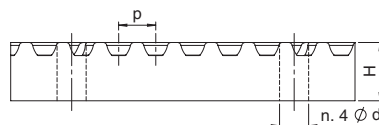
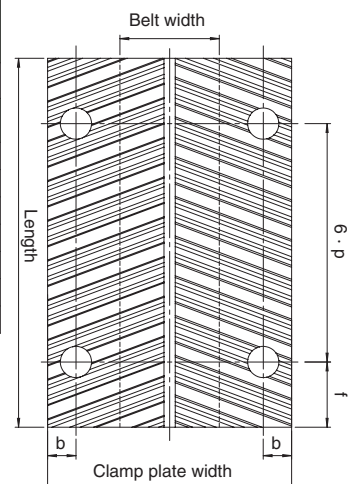

SIT Raw clamp plates

Part Number PIA -T5 -S

Clamp plate _____

Pitch _____

Raw execution _____

(Note: fore Eagle type specify the belt width)

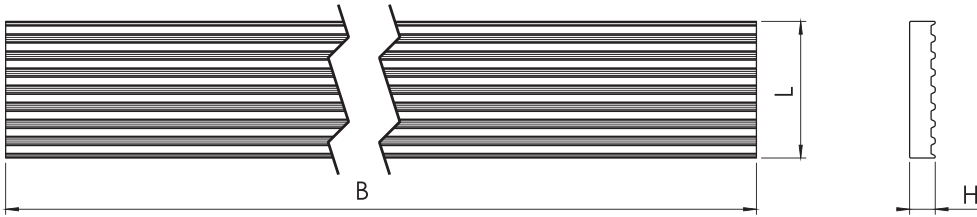

Type	B [mm]	H [mm]	L [mm]
T5	750	8	41,8
AT5	750	8	41,8
T10	750	15	80,0
AT10	750	15	80,0

Type	B [mm]	H [mm]	L [mm]
XL	750	8	42,5
L	750	15	76,6
H	750	22	106,9

Type	B [mm]	H [mm]	L [mm]
3M	750	5	25,0
5M	750	8	41,8
8M	750	15	66,0
14M	750	22	116,0

Part Number PIA -E8 -WS

Clamp plate _____

Pitch _____

Raw execution _____

(Note: fore Eagle type specify the belt width)

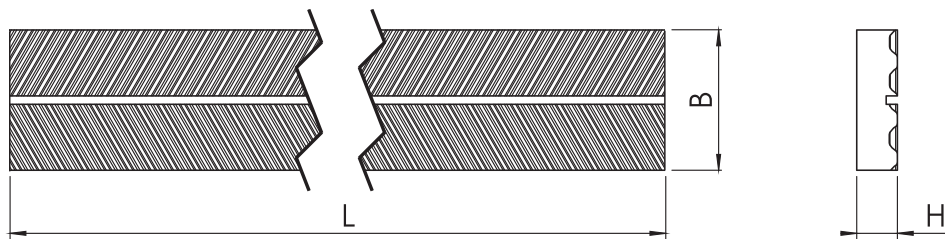

EAGLE Belts			Raw clamp plates														
Pitch	L [mm]	H [mm]	Code														
			PIA-E5-12,5S	PIA-E5-25S	PIA-E8-YS	PIA-E8-MS	PIA-E8-WS	PIA-E8-LS	PIA-E10-25S	PIA-E10-32S	PIA-E10-50S	PIA-E10-75S	PIA-E10-100S	PIA-E14-BS	PIA-E14-GS	PIA-E14-OS	PIA-E14-RS
			B [mm]														
EAGLE 5	710	7,5	30	45	-	-	-	-	-	-	-	-	-	-	-	-	-
EAGLE 8	730	14,5	-	-	40	50	57	75	-	-	-	-	-	-	-	-	-
EAGLE 10	710	14,5	-	-	-	-	-	-	50	57	75	100	125	-	-	-	-
EAGLE 14	710	22	-	-	-	-	-	-	-	-	-	-	-	65	82,5	100	136